

PROFESSIONAL POWER PULLS

LIFETIME WARRANTY

- Makes Tough Projects An Easy, One-Person Job
- Releases Load One Notch-at-a-Time
- Cable Limiter, Keeps Two Wraps Of Cable On The Ratchet Wheel
- Meets OSHA Specs
- Meets ASME Specs B.30.21-1999
- Cast Aluminum Ratchet Wheel
- Zinc Plated For Rust Resistance
- Galvanized Aircraft Cable
- Contour Grip
- Drop Forged Steel Safety Hooks

MODEL	LEVERAGE	CAPACITY	PULL	CABLE	WEIGHT
144	18:1	1 Ton	12'	3/16"	7.2 lbs
72A	36:1	2 Ton	6'	3/16"	8.1 lbs
384	18:1	1/2 Ton	32'	1/8"	7.4 lbs
180	18:1	1400 lbs	15'	5/32"	7.1 lbs
216	18:1	1400 lbs	18'	5/32"	7.3 lbs
72	18:1	1 Ton	6'	3/16"	6.9 lbs
108	18:1	1 Ton	9'	3/16"	7.1 lbs
144BX Box Car	18:1	1 Ton	12'	3/16"	9.0 lbs
144D Convertible	36:1	2 Ton	6'	3/16"	8.9 lbs

15002 4-TON EXTRA HEAVY-DUTY CABLE PULLER

LIFETIME WARRANTY

- Cast Frame, Ratchet Wheel, And Pawl For Added Strength
- Drop Forged Safety Hooks
- Zinc Plated Detachable Handle
- Meets OSHA Specs
- Meets ASME Specs B.30.21-1999
- 20 Feet Of Extra Heavy Duty 5/16" Aircraft Cable
- Contour Grip
- Only 24 lbs

Cable lengths of 25, 30, 35, & 40 ft are available.

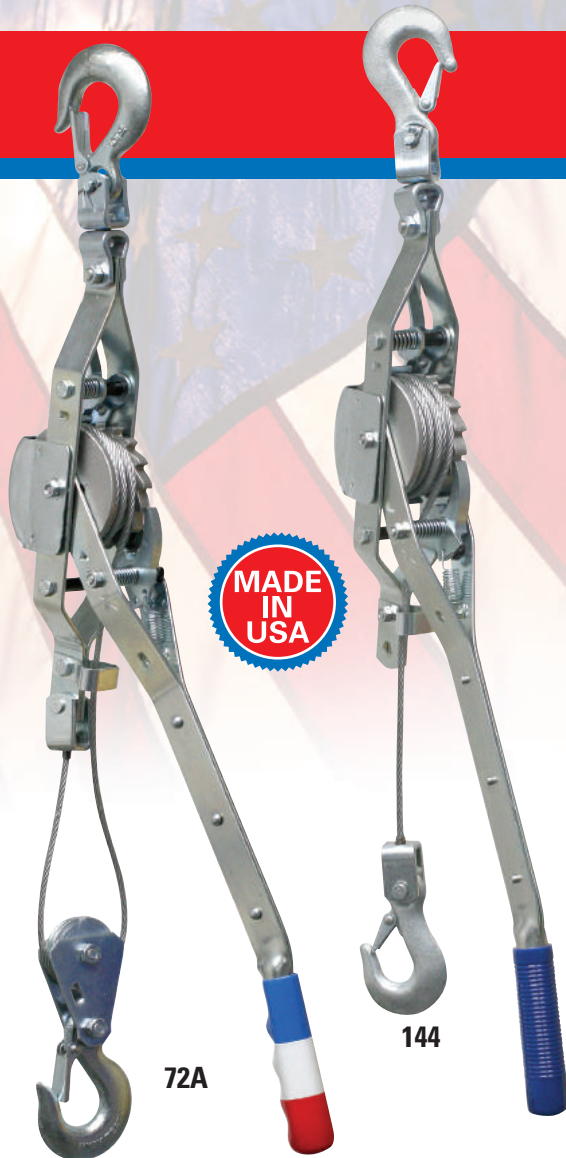

AMERICAN POWER PULL®

115 E. Linfoot St.
Wauseon, OH 43567-0109
Phone: 800-808-5922 • Fax: 800-707-7855
www.americanpowerpull.com
Copyright © 2014 American Powerpull, All Rights Reserved.

CABLE PULLERS

18500 1-TON CABLE PULLER

25-YEAR WARRANTY

- 1-Ton Double Ratchet Drive
- Cable Limiter, Keeps Two Wraps Of Cable On The Ratchet Wheel
- Releases Load One Notch-at-a-Time
- 12-Foot Pull
- Zinc Plated For Rust Resistance
- Drop Forged Safety Hooks
- Meets OSHA Specs
- Meets ASME Spec B30.21-1999

18600 2-TON CABLE PULLER

25-YEAR WARRANTY

- 2-Ton Double Ratchet Drive
- Cable Limiter, Keeps Two Wraps Of Cable On The Ratchet Wheel
- Releases Load One Notch-at-a-Time
- 6-Foot Pull
- Zinc Plated For Rust Resistance
- Drop Forged Safety Hooks
- Meets OSHA Specs
- Meets ASME Spec B30.21-1999

18650 4-TON CABLE PULLER

25-YEAR WARRANTY

- 4-Ton Double Ratchet Drive
- Cable Limiter, Keeps Two Wraps Of Cable On The Ratchet Wheel
- Releases Load One Notch-at-a-Time
- 5/16" Galvanized Aircraft Cable
- 6-Foot Pull
- Zinc Plated For Rust Resistance
- Drop Forged Safety Hooks
- Meets OSHA Specs
- Meets ASME Spec B30.21-1999

MODEL	LEVERAGE	CAPACITY	PULL	CABLE	WEIGHT
18500	18:1	1 Ton	12'	3/16"	7.1 lbs
18600	36:1	2 Ton	6'	3/16"	7.5 lbs
18650	42.1	4 Ton	6'	5/16"	13.9 lbs

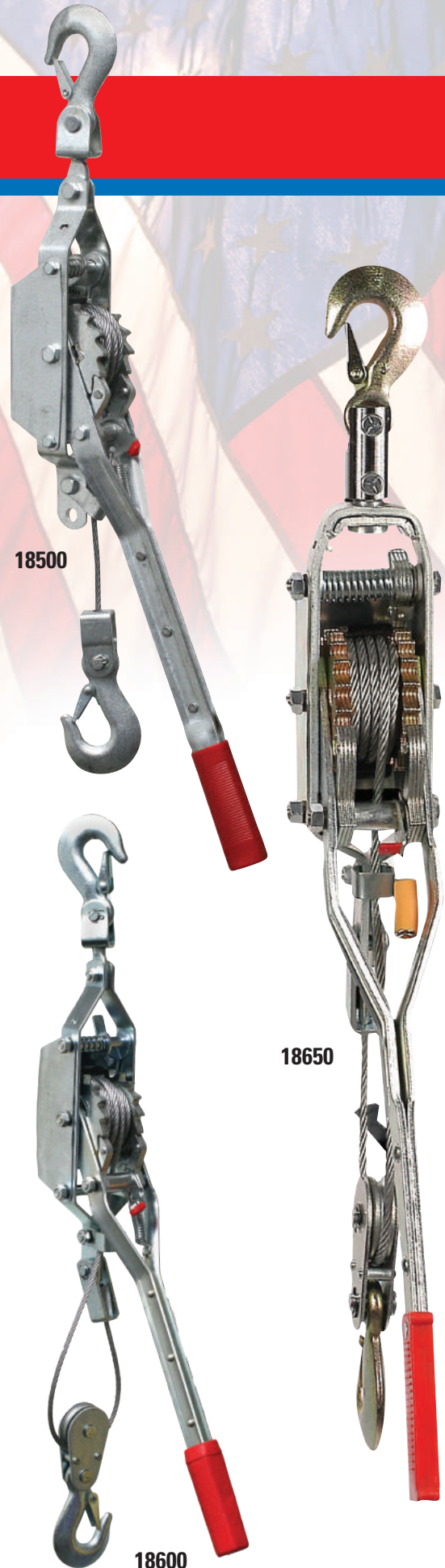

115 E. Linfoot St.
 Wauseon, OH 43567-0109
 Phone: 800-808-5922 • Fax: 800-707-7855
www.americanpowerpull.com
 Copyright © 2014 American Powerpull, All Rights Reserved.

SPECIALTY POWER PULLS

PORTA PULLER®

25-YEAR WARRANTY

- 1 Ton Capacity, 8 Foot Length Of Pull
- Collapsible Handle For Easy Storage
- Convenient Carrying Case
- Meets OSHA Specifications
- Meets ASME & ANSI Standards

MODEL	LEVERAGE	CAPACITY	PULL	WEIGHT
EZ2000	13:1	1 Ton	8'	5 lbs

PROFESSIONAL POWER STRAP PULLERS

LIFETIME WARRANTY – MADE IN THE USA

- Replaces Cable With One-Inch Nylon Strap
- Conforms Easily To Irregular Loads
- 3 Different Lengths Of Strap Available
- Releases Load One Notch-at-a-Time
- Cast Aluminum Ratchet Wheel
- Zinc Plated For Rust Resistance
- Contour Grip
- Drop Forged Steel Safety Hooks
- Meets ASME Standards

MODEL	LEVERAGE	CAPACITY	PULL	WEIGHT
19200	36:1	2 Ton	6'	7.3 lbs
19100	18:1	1 Ton	12'	6.1 lbs
19000	18:1	1 Ton	25'	6.4 lbs

STRAP PULLERS

25-YEAR WARRANTY

- Double Ratchet Drive
- Replaces Cable With One-Inch Web Strap
- Releases Load One Notch-at-a-Time
- 3 Different Lengths Of Strap Available
- Zinc Plated For Rust Resistance
- Drop Forged Safety Hooks
- Conforms Easily To Irregular Loads

MODEL	LEVERAGE	CAPACITY	PULL	WEIGHT
18700	18:1	1 Ton	25'	6.4 lbs
18800	18:1	1 Ton	12'	6.1 lbs
18900	36:1	2 Ton	6'	7.3 lbs



115 E. Linfoot St.
Wauseon, OH 43567-0109
Phone: 800-808-5922 • Fax: 800-707-7855
www.americanpowerpull.com
Copyright © 2014 American Powerpull, All Rights Reserved.

ACCESSORIES



AGP101T

TOW CABLE

- Strong 1/4" X 12' Cable Clad In Soft Vinyl, With Forged Hooks On Each End
- Use As An Extension For Vehicle Towing
- Weight: 3.2 lbs

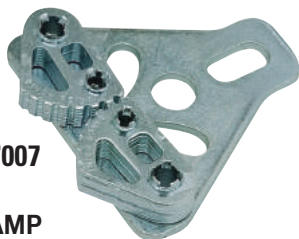

PP7007

HAND CLAMP

- For Use On Smooth Or Barbed Wire
- Economically Priced & Designed For Long Wear
- 1000 lbs Pull Rating
- Weight: 1.2 lbs
- Cable Capacity Up To 5/8" Cable



PP7008

FENCE & WIRE HAND GRIP

- For Stretching Smooth or Barbed Wire Fence
- Can Be Used For Pulling Wire Through Conduit
- Spring Loaded Grip With 500 lb Maximum Capacity
- Cable Capacity Up To 1/4" Cable



PP7069

PULL CHAIN

- A Must For Stretching Link Fence
- 1000 lbs. Pull Rating
- Weight: 4 lbs



PP7134

MOTOR LIFT SLING

- For Lifting Automotive Engines
- Bolts To Motor Mounting Holes
- 600 lbs Lift Rating
- Weight: 2.7 lbs



PP7136

ENGINE LIFT SLING COMBO™

- Use Either Slip Hooks Or Engine Bolt Attachments
- Use As A Sling Or Engine Lift
- 600 lbs Lift Rating
- Weight: 4 lbs

HEAVY DUTY SNAP HOOK

- Drop Forged, Zinc Plated. Average Tensile Strength 4,400 lbs. 3-1/2" Long, 5/8" Eye And 1/2" Snap Opening
- Weight: .4 lbs

10005



PULLEY BLOCK & SAFETY HOOK

- Provides Double Pulling Power For Winches By Double-Lining The Cable Through It
- Assembled And Sold With Safety Hook Included
- Weight: 1.3 lbs

AGP101



SAFETY HOOK

- To Meet OSHA Requirements When Lifting And Moving A Load Horizontally.

PP7143

- 5/16" With 1-Ton Capacity
- Weight: .6 lbs



PP7143 Shown

PP7142

- 1/4" With 1/2 Ton Capacity
- Weight: .4 lbs



PP7061

OVERSIZE HOOK

- Large 3" Throat Opening Hooks (Standard On 144BX)
- Fits Any Power Pull Model
- Weight: 1.4 lbs



115 E. Linfoot St.
Wauseon, OH 43567-0109
Phone: 800-808-5922 • Fax: 800-707-7855

www.americanpowerpull.com
Copyright © 2014 American Powerpull, All Rights Reserved.

POWER JACK



14100

14100 4-TON POWER JACK

LIFETIME WARRANTY

- A Must For The Off-Roader
- Low Pick Up, Lifting Nose Only 4.5" From The Base
- 4" Long Lifting Nose
- Safety Shear Pin

POWER JACK ACCESSORIES

14001 JACK RACK

- Use Jack Rack To Mount The Power Jack Vertically Or Horizontally

14005 OFF ROAD BASE

- Use the off road base to steady the jack in uneven or soft conditions



14005

14252C TOP PIECE

- Adjustable Top Pieces Can Be Used For Clamping And Stretching
- 400 lbs. Capacity

14226 FIX IT KIT

- Contains the most common parts needed to service your jack



14001

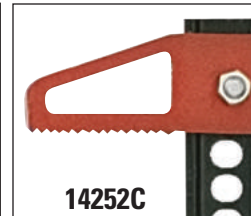

14252C



14226



**AMERICAN
POWER PULL®**

115 E. Linfoot St.
Wauseon, OH 43567-0109
Phone: 800-808-5922 • Fax: 800-707-7855
www.americanpowerpull.com
Copyright © 2014 American Powerpull, All Rights Reserved.

FENCE TOOLS

UTICA STYLE FENCE PLIERS

5-YEAR WARRANTY

- Stainless Steel Construction Makes Pliers Rust Resistant
- Precision Manufactured For Smooth Performance Eliminates A Break In Period.
- Front & Side Cutters For Maximum Convenience.

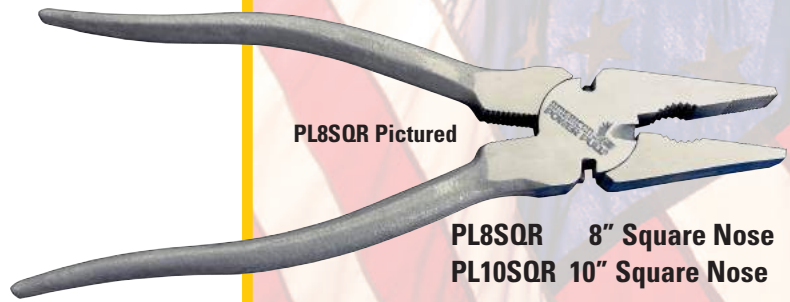

PL8SQR Pictured

PL8SQR 8" Square Nose

PL10SQR 10" Square Nose

PL8RND 8" Round Nose

PL10RND 10" Round Nose

HAMMERHEAD PLIERS

5-YEAR WARRANTY

- Head Width: 3-1/4 in.
- Head Length: 3-3/4 in.
- Handle Length: 7 in.
- Overall Length: 10-3/4 in.
- Stainless Steel
- Cushion Grips

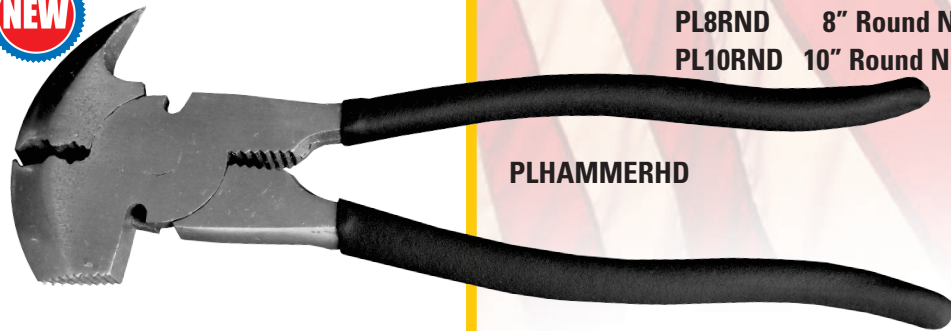

PLHAMMERHD

HOG NOSE PLIERS

5-YEAR WARRANTY

- Head Width: 1-1/8 in.
- Head Length: 2-1/4 in.
- Handle Length: 4-3/8 in.
- Overall Length: 6-5/8 in.
- Zinc Plated Iron

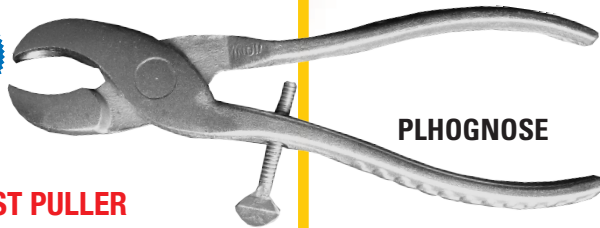

PLHOGNOSE

14600 POST PULLER

25 YEAR WARRANTY

- Pulls Post Straight Up So It Will Not Bend
- Long Handle For Maximum Leverage
- No Need To Attach Costly Power Equipment
- Lightweight 13.5 lbs - Very Portable
- 36" L X 5" W X 4" H
- Perfect Companion To An American Power Pull Cable Puller

14601 POST PULLER

25 YEAR WARRANTY

- Pulls Post Straight Up So It Will Not Bend
- Long Handle For Maximum Leverage
- No Need To Attach Costly Power Equipment
- Lightweight 11.65 lbs - Very Portable
- 24" L X 5" W X 4" H
- Perfect Companion To An American Power Pull Cable Puller



14700

14600

14700 POST POUNDER

25 YEAR WARRANTY

- Makes Short Work Out Of Driving Steel Fence Posts
- Tapered Handles For Comfortable Hand Placement
- 2-11/16" Tube Diameter With Weighted Solid Steel Head
- Dimensions: 23 3/8" x 8.5" x 3



**AMERICAN
POWER PULL®**

115 E. Linfoot St.
Wauseon, OH 43567-0109
Phone: 800-808-5922 • Fax: 800-707-7855

www.americanpowerpull.com

Copyright © 2014 American Powerpull, All Rights Reserved.

HEAVY-DUTY JACKS & HAND WINCHES

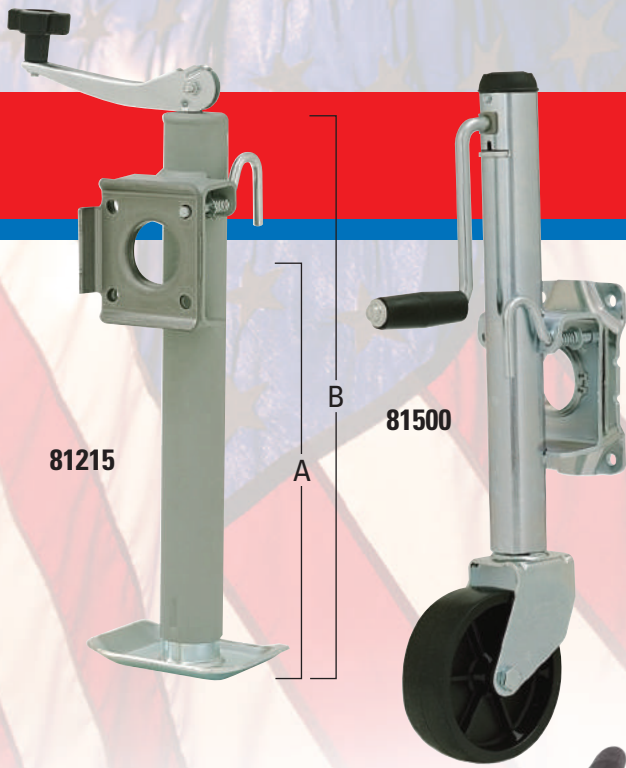

TRAILER JACKS 5-YEAR WARRANTY

- Heavy – Duty Construction
- Rolled Acme Threads
- Steel Anti – Friction Thrust Bearings
- Smooth Cranking Operation

MODEL NO.	RATED CAPACITY	LIFT	MOUNTING HARDWARE (Included)	COLLAPSED DIMENSION	NET WEIGHT
81210	2000 lbs	15"	Swivel 2 1/2" Dia. with Snap Ring	A: 20" B: 16"	13.7 lbs
81215	2000 lbs	10"	Swivel 2 1/2" Dia. with Snap Ring	A: 15" B: 11"	11.5 lbs
81220	2000 lbs	15"	2" Dia. Tube with 5/8" Pin	A: 20" B: 16"	13.3 lbs
81315	2000 lbs	10"	2" Dia. Tube with 5/8" Pin	A: 15" B: 11"	11.2 lbs
81320	5000 lbs	15"	2" Dia. Tube with 5/8" Pin	A: 20" B: 16"	13.3 lbs



MARINE JACK 5-YEAR WARRANTY

- Heavy – Duty Construction
- Zinc Plated For Rust Resistance
- Large Diameter Grip
- Smooth Cranking Operation

MODEL	RATED CAPACITY	LIFT	MOUNTING HARDWARE (Included)	NET WEIGHT
81500	1000 lbs	10"	3" x 5" Bracket	16.0 lbs



HAND WINCHES 5-YEAR WARRANTY

- Easy To Use
- Zinc Plated Finish For Rust Resistance
- Meets SAE Standards J1853
- Smooth Cranking Operation
- Strap And Safety Hook Included

MODEL	GEAR RATIO	STRAP LENGTH	RATED CAPACITY	RATCHET	WEIGHT
AG226	3:1:1	20'	600 lbs	One way	5.2 lbs
AG229	4.1:1	30'	1,100 lbs	One way	5.6 lbs
AG590	4.1:1	30'	1,500 lbs	One way	5.6 lbs
AG594	5.1:1	30'	1,800 lbs	Two way	12.0 lbs
AG596	5.1:1	30'	2,600 lbs	Two way	13.9 lbs



WINCH CABLE

- Galvanized 3/16" X 25' Of Steel Cable With Heavy Duty Safety Snap
- Weight: 2.3 lbs

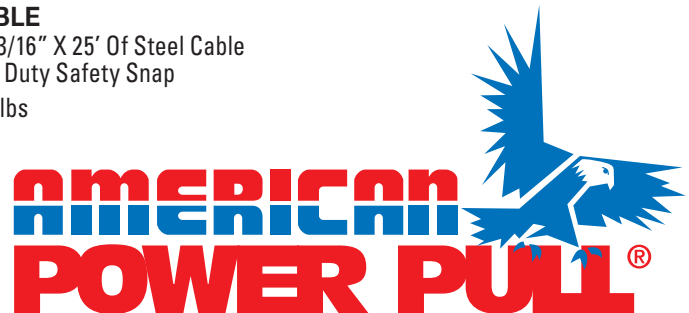

115 E. Linfoot St.
 Wauseon, OH 43567-0109
 Phone: 800-808-5922 • Fax: 800-707-7855
www.americanpowerpull.com
 Copyright © 2014 American Powerpull, All Rights Reserved.

STRETCH CORDS & RUBBER STRAPS

STRETCH CORDS

1-YEAR WARRANTY

- Extra Heavy Vinyl Coated Hooks
- Quality Rubber Covered With Multi – Color Braid

PART NO.	LENGTH (INCLUDES HOOKS)	SHIP PACKAGE	PACKAGE WEIGHT
12013	13"	10 Each	1.0 lbs
12016	16"	10 Each	1.1 lbs
12018	18"	10 Each	1.1 lbs
12024	24"	10 Each	1.6 lbs
12036	36"	10 Each	1.9 lbs

- 12012 Stretch Cord Assortment Contains 10 Each Of The 12013, 12016, 12024 And 20 Of The 12018.

RUBBER STRAPS

5-YEAR WARRANTY

- High Quality EPDM Rubber
- Ozone Resistant
- Will Not Rot Or Lose Rebound With Exposure To Sunlight

PART NO.	LENGTH (INCLUDES HOOKS)	SHIP PACKAGE	PACKAGE WEIGHT
12214	14"	10 Each	2.0 lbs
12219	19"	10 Each	2.1 lbs
12224	24"	10 Each	2.4 lbs
12235	35"	10 Each	3.1 lbs
12245	45"	10 Each	3.7 lbs

- 12213 Rubber Strap Assortment Contains 10 Each Of The 12214, 12219, 12235 And 20 Of The 12224



12012



12213



115 E. Linfoot St.
 Wauseon, OH 43567-0109
 Phone: 800-808-5922 • Fax: 800-707-7855
www.americanpowerpull.com
 Copyright © 2014 American Powerpull, All Rights Reserved.

WEB STRAPS



16300



16400



16600



16700



16800

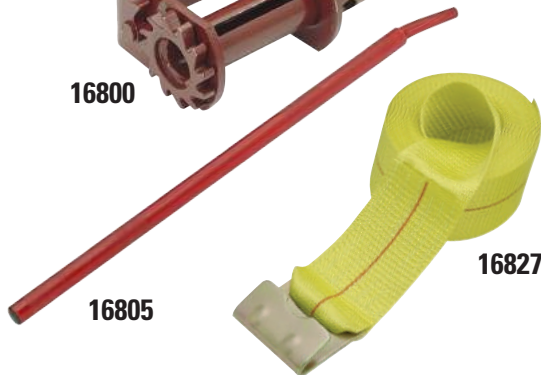

16805

16827

TIE DOWNS, TOW STRAPS AND LIFT SLINGS

5-YEAR WARRANTY



- Made From Heavy Polyester And Nylon Webbing
- Lifting Sling Has A Special Red Core To Indicate Excessive Wear
- Lift Sling Has 5 To 1 Safety Factor As Required By OSHA
- Tie Downs Have Vinyl Covered Hoods And Non-slip Cam Buckle

MODEL	DESCRIPTION	CAPACITY	WIDTH X LENGTH	WEIGHT
16000	Tow Strap	10,000 lbs	1 3/4" X 15'	2.0 lbs
16100	Tow Strap	10,000 lbs	1 3/4" X 25'	2.6 lbs
16200	Lift Sling	7,600 lbs	1" X 8'	1.0 lbs
16400	Tie Down	2,400 lbs	1" X 9'	1.2 lbs
16450	Tie Down	1,800 lbs	1" X 10'	1.2 lbs
16500	Tie Down	1,200 lbs	1" X 15'	1.3 lbs
16550	Tie Down	2,400 lbs	1" x 5 1/2'	2.1 lbs pair
16600	Ratchet Tie Down	3,000 lbs	1" X 16'	1.5 lbs

RATCHET AND TRUCK LOAD BINDER

5-YEAR WARRANTY

- Extra Heavy Duty Polyester Webbing
- Ratchet Binder Is Extra Wide To Accommodate A Gloved Hand

MODEL	DESCRIPTION	CAPACITY	WIDTH X LENGTH	WEIGHT
16300	Ratchet Binder	6,000 lbs	1 3/4" X 15'	3.3 lb
16700	Ratchet Binder	10,000 lbs	2" X 30'	6.1 lb
16701	J Hook	10,000 lbs	2" X 30'	6.1 lb
16727	Flat Hook Binder	10,000 lbs	2" X 30'	3.2 lb
 16730	Flat Hook Binder	20,000 lbs	4" X 30'	15 lb
 16731	J Hook	20,000 lbs	4" X 30'	15 lb
16827	Flat Hook Binder	15,000 lbs	4" X 27'	4.6 lb
16828	Delta Ring Binder	20,000 lbs	4" X 27'	4.7 lb
16800	Winch	20,000 lbs	N/A	9.9 lb
16805	Winch Bar	N/A	31.5"	5.2 lb

AMERICAN POWER PULL 

115 E. Linfoot St.
 Wauseon, OH 43567-0109
 Phone: 800-808-5922 • Fax: 800-707-7855
www.americanpowerpull.com
 Copyright © 2014 American Powerpull, All Rights Reserved.

LOAD BINDERS

13030 SAMSON MITE MINI LOAD BINDER

25-YEAR WARRANTY

- High Quality Steel
- Heat Treated
- For Use With 1/4" Chain

BINDER NUMBER	SIZE GRADE	APPROX WEIGHT	HANDLE LENGTH	TAKE UP	WORKING LOAD LIMIT	PROOF TEST LOAD	MIN BREAKING STRENGTH
13010	Mini	1/2 lb	3 1/4"	2"	175 lbs	350 lbs	525 lbs
13030	1/4"	1 1/4 lb	7 3/4"	3 1/2"	375 lbs	750 lbs	1,500 lbs

13040 – 13060 FORGED LOAD BINDERS

25-YEAR WARRANTY

- High Quality Forged Steel
- Heat Treated
- Ball And Socket Construction

BINDER NUMBER	SIZE GRADE	APPROX WEIGHT	HANDLE LENGTH	TAKE UP	WORKING LOAD LIMIT	PROOF TEST LOAD	MIN BREAKING STRENGTH
13040	1/4": 40	3.1 lbs	11 1/2"	3"	2,600 lbs	5,200 lbs	7,800 lbs
13050	5/16": 70 3/8": 40	7.8 lbs	15 1/2"	4"	5,400 lbs	10,800 lbs	19,000 lbs
13060	3/8": 70 1/2": 30	12.1 lbs	18 1/2"	4 1/2"	9,200 lbs	18,400 lbs	28,000 lbs

13140 – 13160 MALLEABLE LOAD BINDERS

25-YEAR WARRANTY

- Cast Handle
- High Quality Forged Steel
- Heat Treated
- Ball And Socket Construction

BINDER NUMBER	SIZE GRADE	APPROX WEIGHT	HANDLE LENGTH	TAKE UP	WORKING LOAD LIMIT	PROOF TEST LOAD	MIN BREAKING STRENGTH
13140	1/4": 40	3.1 lbs	11 1/2"	3"	2,600 lbs	5,200 lbs	7,800 lbs
13150	5/16": 70 3/8": 40	7.8 lbs	15 1/2"	4"	5,400 lbs	10,800 lbs	19,000 lbs
13160	3/8": 40 1/2": 30	12.1 lbs	18 1/2"	4 1/2"	9,200 lbs	18,400 lbs	28,000 lbs

RATCHET LOAD BINDERS

25-YEAR WARRANTY

- Turnbuckle Style Ratchet
- Spring Loaded Pawls
- Forged Steel Components
- Heat Treated

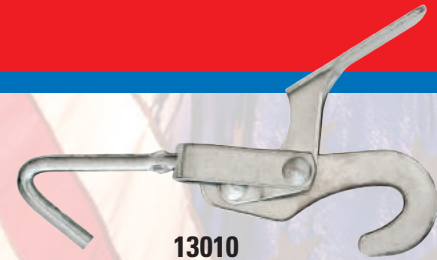

13010



13030



13050



13150

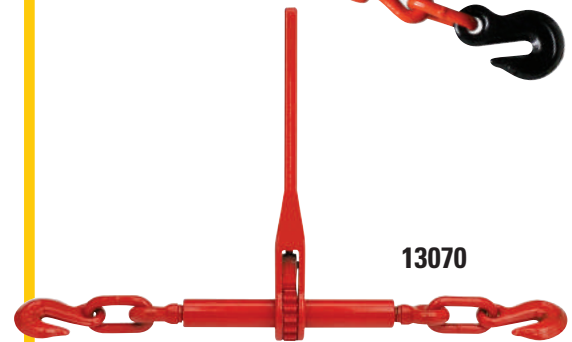

13070

BINDER NUMBER	SIZE GRADE	APPROX WEIGHT	HANDLE LENGTH	TAKE UP	WORKING LOAD LIMIT	PROOF TEST LOAD	MIN BREAKING STRENGTH
13064	1/4": 40	3.7 lbs	8 1/2"	6 1/2"	2,600 lbs	5,200 lbs	9,200 lbs
13070	5/16": 70 3/8": 40	10.4 lbs	14"	9 5/16"	5,400 lbs	10,800 lbs	19,000 lbs
13080	3/8": 70 1/2": 10	11.8 lbs	14"	8 5/8"	9,200 lbs	18,400 lbs	33,000 lbs
13085	1/2": 70 5/8": 30	12.1 lbs	14"	8"	13,000 lbs	26,000 lbs	46,000 lbs



115 E. Linfoot St.
 Wauseon, OH 43567-0109
 Phone: 800-808-5922 • Fax: 800-707-7855
www.americanpowerpull.com
 Copyright © 2014 American Powerpull, All Rights Reserved.

HAND TRUCKS



3400

3439



3500

3400 HAND TRUCK

10-YEAR WARRANTY*

- 800 lb Capacity
- 10" x 3 1/2" Pneumatic Tires
- Easy Storage, Standing Up Or Hung From Handle
- Also Available With Solid Wheels

3439 SACK TRUCK

10-YEAR WARRANTY*

- 600 lb Capacity
- Perfect For Carrying Large Feed Bags
- Durable Tube Construction
- Only 27 lbs
- 10" x 3 1/2" Pneumatic Tires

3500 APPLIANCE DOLLY

10-YEAR WARRANTY

- 550 lb Capacity
- Built Tough For Moving Bulky Appliance
- Durable Tube Construction
- Securing Strap To Prevent Slipping
- 6" Solid Rubber Tires
- Stair Climbers To Help Move Load

MODEL	HANDLE STYLE	DIMENSIONS			NOSE PLATE	WHEELS	APPROX CAP	WEIGHT
		H	L	W				
3400	Loop	51 1/2"	18"	21"	8 1/2" x 14"	10" x 3 1/2"	800 lbs	22 lbs
3419	Loop	51 1/2"	18"	21"	8 1/2" x 14"	Solid Tire	800 lbs	22 lbs
3439	Dual	44"	13"	21"	7" x 14"	10" x 3 1/2"	600 lbs	27 lbs
3500	Cont	60"	12"	24"	4" x 24"	8" x 2"	550 lbs	39 lbs

*1-YEAR WARRANTY ON PNEUMATIC TIRES

AMERICAN POWER PULL 

115 E. Linfoot St.
Wauseon, OH 43567-0109
Phone: 800-808-5922 • Fax: 800-707-7855

www.americanpowerpull.com

Copyright © 2014 American Powerpull, All Rights Reserved.

HAND TRUCKS

3469 2-IN-1 CART

10-YEAR WARRANTY*

- Heavy Duty Frame
- 800 lb Capacity
- Solid Tubular Construction
- Loop Handle Allows For Horizontal Loading
- Extra Long Stair Climbers
- 10" x 3 1/2" Pneumatic Tires And 4" Caster Wheels



3469

5200 WELDING CART

10-YEAR WARRANTY

- Holds Both Oxygen And Acetylene Tanks
- Up To 122 Cubic Feet Oxygen And 169 Cubic Feet Acetylene
- Includes A Tray For Tools
- Link Chains Secure Tanks
- 10" Solid Wheels



5200



5300BD

5300 BIG DADDY WELDING CART

10-YEAR WARRANTY

- Holds Both Oxygen And Acetylene Tanks
- 45" x 30" x 22"
- Includes A Tray For Tools
- Link Chains Secure Tanks
- 13" Solid Wheels

5400 HEAVY DUTY HAND TRUCK

10-YEAR WARRANTY

- Heavy Duty Frame
- 800 lb Capacity
- Solid Tubular Construction
- Loop Handle Allows For Horizontal Loading
- Extra Long Stair Climbers
- Available With Solid And Pneumatic Tires



5400

MODEL	HANDLE STYLE	DIMENSIONS H L W	NOSE PLATE	WHEELS	APPROX CAP	WEIGHT
3469	Cont	49 1/2" 14 1/2" 18 1/2"	8 1/2" x 14"	10" x 3 1/2"	800 lbs	28 lbs
5400	Loop	50" 18" 19 3/4"	8 1/2" x 14"	Solid Tire	800 lbs	37.9 lbs
*5419	Loop	50" 18 1/2" 22 1/2"	8 1/2" x 14"	10" x 3 1/2"	800 lbs	33.9 lbs

* 1-YEAR WARRANTY ON PNEUMATIC TIRES

**AMERICAN
POWER PULL®**

115 E. Linfoot St.
Wauseon, OH 43567-0109
Phone: 800-808-5922 • Fax: 800-707-7855

www.americanpowerpull.com

Copyright © 2014 American Powerpull, All Rights Reserved.

CHAIN PRODUCTS



400 SERIES CHAIN BLOCKS

LIFETIME WARRANTY

- Thick Steel Construction
- Heat Treated
- Triple Geared
- Drop Forged Safety Hooks
- All Models Are Available With Different Chain Lengths

MODEL	RATED CAPACITY	UNIT LIFT	LOAD CHAIN DIAMETER		HAND CHAIN	NET WEIGHT
			IN	MM		
NEW 402	1/4 Ton	10'	3/16	4	20'	9.7 lbs
402-15	1/4 Ton	15'	3/16	4	30'	13.6 lbs
402-20	1/4 Ton	20'	3/16	4	40'	17.5 lbs
405	1/2 Ton	10'	1/4	6	20'	21 lbs
405-15	1/2 Ton	15'	1/4	6	30'	26.4 lbs
405-20	1/2 Ton	20'	1/4	6	40'	31.7 lbs
NEW 407	3/4 Ton	10'	1/4	6	20'	25.6 lbs
410	1 Ton	10'	1/4	6	20'	5.6 lbs
410-15	1 Ton	15'	1/4	6	30'	30.9 lbs
410-20	1 Ton	20'	1/4	6	40'	36.3 lbs
415	1 1/2 Ton	10'	5/16	8	20'	35.9 lbs
415-15	1 1/2 Ton	15'	5/16	8	30'	43.2 lbs
415-20	1 1/2 Ton	20'	5/16	8	40'	50.6 lbs
420	2 Ton	10'	5/16	8	20'	39.6 lbs
420-15	2 Ton	15'	5/16	8	30'	46.9 lbs
420-20	2 Ton	20'	5/16	8	40'	54.3 lbs
430	3 Ton	10'	5/16	8	20'	53.6 lbs
430-15	3 Ton	15'	5/16	8	30'	68.4 lbs
430-20	3 Ton	20'	5/16	8	40'	83.1 lbs
450	5 Ton	10'	13/32	10	20'	85.3 lbs
450-15	5 Ton	15'	13/32	10	30'	105.2 lbs
450-20	5 Ton	20'	13/32	10	40'	125 lbs
NEW 490	10 Ton	10'	13/32	10	20'	172.1 lbs

ROLLER BEARING ADJUSTABLE TROLLEYS

MODEL	RATED CAPACITY	NET WEIGHT
505	1/2 Ton	15.3 lbs
510	1 Ton	26.5 lbs
520	2 Ton	45.2 lbs
530	3 Ton	72.8 lbs
550	5 Ton	112.4 lbs

AMERICAN POWER PULL 

115 E. Linfoot St.
 Wauseon, OH 43567-0109
 Phone: 800-808-5922 • Fax: 800-707-7855
www.americanpowerpull.com
 Copyright © 2014 American Powerpull, All Rights Reserved.

CHAIN PRODUCTS

600 SERIES CHAIN PULLERS

LIFETIME WARRANTY

- Thick Steel Construction
- Heat Treated
- Drop Forged Safety Hooks
- All Models Are Available With Different Chain Lengths

LOAD CHAIN

MODEL	RATED CAPACITY	UNIT LIFT	DIAMETER IN	DIAMETER MM	HANDLE LENGTH	NET WEIGHT
NEW 602	1/4 Ton	5'	3/16	4	7"	4.3 lbs
602-10	1/4 Ton	10'	3/16	4	7"	5.5 lbs
602-15	1/4 Ton	15'	3/16	4	7"	6.6 lbs
602-20	1/4 Ton	20'	3/16	4	7"	7.8 lbs
NEW 603	1/2 Ton	5'	3/16	4	7 1/2"	7 lbs
603-10	1/2 Ton	10'	3/16	4	7 1/2"	7.4 lbs
603-15	1/2 Ton	15'	3/16	4	7 1/2"	7.8 lbs
603-20	1/2 Ton	20'	3/16	4	7 1/2"	8.2 lbs
605	3/4 Ton	5'	1/4	6	13"	13.9 lbs
605-10	3/4 Ton	10'	1/4	6	13"	16.6 lbs
605-15	3/4 Ton	15'	1/4	6	13"	19.2 lbs
605-20	3/4 Ton	20'	1/4	6	13"	21.8 lbs
NEW 610	1 Ton	5'	1/4	6	13"	13.9 lbs
615	1 1/2 Ton	5'	5/16	8	18"	24.4 lbs
615-10	1 1/2 Ton	10'	5/16	8	18"	29 lbs
615-15	1 1/2 Ton	15'	5/16	8	18"	33.7 lbs
615-20	1 1/2 Ton	20'	5/16	8	18"	38.3 lbs
635	3 Ton	5'	13/32	10	18"	41.2 lbs
635-10	3 Ton	10'	13/32	10	18"	48.4 lbs
635-15	3 Ton	15'	13/32	10	18"	55.6 lbs
635-20	3 Ton	20'	13/32	10	18"	62.7 lbs
660	6 Ton	5'	13/32	10	18"	65.4 lbs
660-10	6 Ton	10'	13/32	10	18"	79.7 lbs
660-15	6 Ton	15'	13/32	10	18"	94.1 lbs
660-20	6 Ton	20'	13/32	10	18"	108.4 lbs

BEAM CLAMPS

MODEL	RATED CAPACITY	BEAM RANGE	NET WEIGHT
710	1 Ton	3-9" flange	9.9 lbs
720	2 Ton	3-9" flange	11 lbs
730	3 Ton	4-12" flange	23.1 lbs

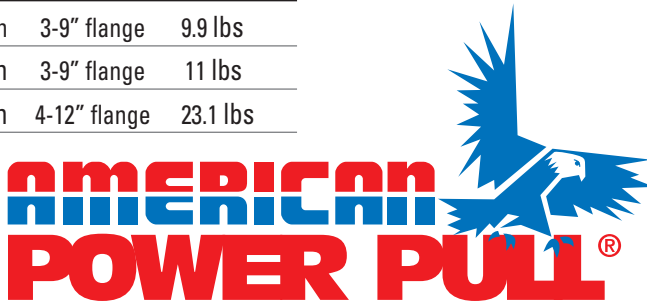
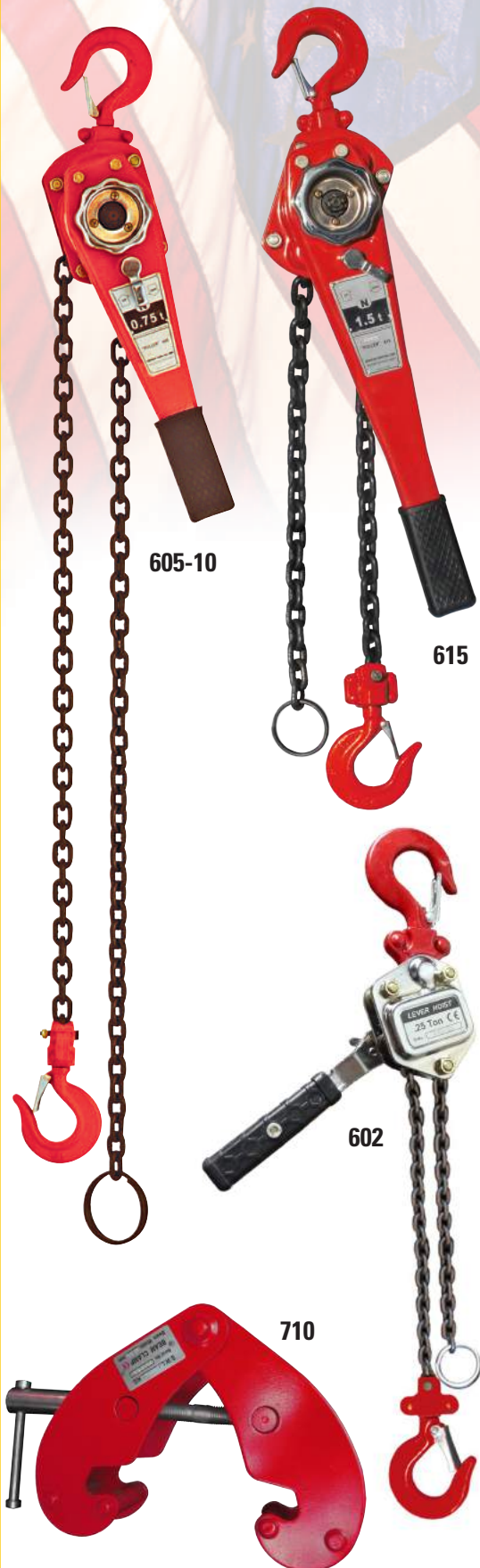

115 E. Linfoot St.
 Wauseon, OH 43567-0109
 Phone: 800-808-5922 • Fax: 800-707-7855
www.americanpowerpull.com
 Copyright © 2014 American Powerpull, All Rights Reserved.

Cable Puller Displays



Model # PP-1



Model # PP-2

**See It,
Hold It,
Try It!**

Model # PP-1

Professional Cable Puller Display

Overall Size: 61³/₄" H x 16¹/₂" W x 12" D

Includes Models:

- (3) PP7007 Wire Fence Hand Clamp
- (3) PP7008 Fence & Wire Hand Grip
- (3) 144 1 Ton Power Pull
- (4) 72A 2 Ton Power Pull

Model # PP-2

Automotive Cable Puller Display

Overall Size: 61³/₄" H x 16¹/₂" W x 12" D

Includes Models:

- (2) PP7136 Motor Lift Sling Combo
- (2) PP7134 Motor Lift Sling
- (3) 18500 1 Ton Cable Puller
- (4) 18600 2 Ton Cable Puller

(Product mix, on either display, can be tailored to customers needs.)

115 East Linfoot Street Wauseon, OH 43567-0109
Phone (800) 808-5922 Fax (800) 707-7855
www.americanpowerpull.com



Power Pull Equipment Display



Model # CH-1

Overall Size: 60" H x 46" W x 18¹/₂" D

Durable

Made of solid steel.

Flexible

We provide labels specific to your product offering.

Versatile

Provides places to hang difficult to display products.

Informative

Comes with laminated sheets listing all important specs and capacities.

Can be used in-run, on an end cap, or as a free standing two-sided display.

115 East Linfoot Street Wauseon, OH 43567-0109
Phone (800) 808-5922 Fax (800) 707-7855
www.americanpowerpull.com

