



20V MAX* LITHIUM POLE SAW INSTRUCTION MANUAL

Model Number LPP120

Thank you for choosing Black & Decker! Go to www.BlackandDecker.com/NewOwner to register your new product.

PLEASE READ BEFORE RETURNING THIS PRODUCT FOR ANY REASON:

If you have a question or experience a problem with your Black & Decker purchase, go to WWW.BLACKANDDECKER.COM/INSTANTANSWERS for instant answers 24 hours a day.

If you can't find the answer or do not have access to the internet, call 1-800-544-6986 from 8 a.m. to 5 p.m. EST Mon. - Fri to speak with an agent.

Please have the catalog number available when you call.

SAVE THIS MANUAL FOR FUTURE REFERENCE.

VEA EL ESPAÑOL EN LA CONTRAPORTADA.

POUR LE FRANÇAIS, VOIR LA COUVERTURE ARRIÈRE.

INSTRUCTIVO DE OPERACIÓN, CENTROS DE SERVICIO Y PÓLIZA DE GARANTÍA. ADVERTENCIA: LÉASE ESTE INSTRUCTIVO ANTES DE USAR EL PRODUCTO.

Model Number LPP120



KEY INFORMATION YOU SHOULD KNOW:

- DO NOT OVER-TENSION CHAIN. Refer to “ADJUSTING CHAIN TENSION” for proper method of tensioning chain.
- Retighten chain frequently during first two hours of use.

*Maximum initial battery pack voltage (measured without a workload) is 20 volts. Measured under a workload, nominal voltage is 18.

TABLE OF CONTENTS

Safety Guidelines - Definitions.....	2
Important Safety Rules	2
Components.....	5
Important Safety Instructions for Battery Chargers.....	6
Important Safety Instructions for Battery Packs.....	7
Charging Procedure.....	8
Installing/Removing Battery Pack	9
Assembly	11
Operating the Saw	12
Accessories.....	14
Maintenance	14
Troubleshooting	14
Service Information	15
Full Two-Year Home Use Warranty.....	15

SAFETY GUIDELINES - DEFINITIONS

It is important for you to read and understand this manual. The information it contains relates to protecting YOUR SAFETY and PREVENTING PROBLEMS. The symbols below are used to help you recognize this information.

⚠DANGER: Indicates an imminently hazardous situation which, if not avoided, will result in death or serious injury.

⚠WARNING: Indicates a potentially hazardous situation which, if not avoided, could result in death or serious injury.

⚠CAUTION: Indicates a potentially hazardous situation which, if not avoided, may result in minor or moderate injury.

CAUTION: Used without the safety alert symbol indicates a potentially hazardous situation which, if not avoided, may result in property damage.

IMPORTANT SAFETY RULES

⚠WARNING: Read and understand all instructions. Failure to follow all instructions listed below may result in electric shock, fire and/or serious personal injury.

SAVE THESE INSTRUCTIONS

Before Operating Pole Saw

- For safe operation, read and understand all instructions before using the Pole Saw. Follow all safety instructions. Failure to follow all safety instructions listed below, can result in serious personal injury.
- Watch what you are doing. Use common sense. Do not operate Pole Saw when you are tired.
- Use Pole Saw for cutting wood only. Do not use Pole Saw for purpose not intended. Do not use for cutting non-wood items.
- Only well-instructed adults should operate Pole Saw. Never allow children to operate.
- Do not allow children or untrained individuals to use this unit.
- Wear the following safety gear when operating Pole Saw:
 - heavy-duty gloves
 - steel-toed safety footwear with non-skid soles
 - safety glasses, goggles or face screen that are marked to comply with ANSI Z87
 - safety hard hat
 - ear mufflers or ear plug
 - face or dust mask (if working in dusty areas)
- Wear heavy long pants and boots. Do not wear loose fitting clothing, short pants, jewelry of any kind, or go barefoot.
- Secure long hair so it is above shoulder level to prevent entanglement in any moving parts.
- Before cutting, always provide the following:
 - clear work area
 - secure footing
 - planned retreat path from falling limbs

- Inspect tree before trimming. Make allowance for branches to fall freely to the ground.
- Do not use your Pole Saw to fell saplings.

While Operating Pole Saw

- Stay alert. Use common sense while operating the unit.
- Keep work area clean. Cluttered areas invite injuries.
- Keep children, animals and bystanders at least 50 ft. (15 m) away from Pole Saw. Only Pole Saw user should be in work area.
- Do not use the Pole Saw to cut down trees.
- Grip Pole Saw securely - one hand on the pole, the other on the handle.
- Keep finger off trigger until ready to make cut.
- Before starting Pole Saw, make sure chain is not touching anything.
- Keep all parts of body away from chain when Pole Saw is running.
- Do not force Pole Saw while cutting. Apply light pressure. It will do the job better and safer at the rate for which it was intended.
- Carry Pole Saw from one place to another
 - with battery removed
 - by holding pole at balance point
 - with guide bar and chain to rear and with scabbard attached
- Do not cut small brush and saplings with the Pole Saw. Slender matter may catch in the chain and be whipped toward you. This could also pull you off balance.
- Do not operate in poor lighting.
- Keep firm footing and balance. Do not overreach. Overreaching can result in loss of balance or exposure to hot surfaces.
- Keep all parts of your body away from any moving part.
- Do not, under any circumstance, use any attachment or accessory on this product, which was not provided with the product, or identified as appropriate for use with this product in this Instruction Manual.

Do not operate Pole Saw

- while under the influence of alcohol, medication, or drugs
- in rain or in damp or wet areas
- where highly flammable liquids or gases are present
- if Pole Saw is damaged, adjusted wrong, or not fully and securely assembled
- if trigger does not turn Pole Saw on and off. Chain must stop moving when you release trigger. Have faulty switch replaced by authorized service center. See “Service Information”.
- while in a hurry
- while in tree or on a ladder
- while on aerial booms, buckets or platforms
- during high wind or storming weather

GENERAL SAFETY RULES

⚠ WARNING: Shock Hazard. To protect yourself from electrocution, do not operate within 50 feet (15 m) of overhead electrical lines. Failure to do this could result in severe personal injury.

- To protect yourself from falling branches do not stand directly under the branch or limb being cut. This unit should not be held at an angle over 60 degrees from ground level.
- Keep the handles dry, clean, and free of oil.
- Before you start the unit, make sure the chain is not contacting any object.
- Make sure the cutting chain has stopped before setting the unit down.

Service

- **Tool service must be performed only by qualified repair personnel.** Service or maintenance performed by unqualified personnel could result in a risk of injury. See “Service Information”.
- **When servicing a tool, use only identical replacement parts. Follow instructions in the Maintenance section of this manual.** Use of unauthorized parts or failure to follow Maintenance Instructions may create a risk of electric shock or injury.

Guard Against Kickback

⚠️ WARNING: KICKBACK may occur when the nose or tip of the guide bar touches an object, or when the wood closes in and pinches the saw chain in the cut. Tip contact in some cases may cause a lightning fast reverse reaction, kicking the guide bar up and back towards the operator. Pinching the saw chain along the top of the guide bar may push the guide bar rapidly back towards the operator. Either of these reactions may cause you to lose control of the saw which could result in serious injury to user.

The following precautions should be followed to minimize kickback:

- Grip Pole Saw firmly. Hold the saw firmly with both hands when the unit is running. Use a firm grip with thumbs and fingers encircling the saw handle and pole.
- Do not over reach.
- Keep proper footing and balance at all times.
- Don't let the nose of the guide bar contact a log, branch, ground or other obstruction.
- Do not extend Pole Saw handle above shoulder height.
- Use devices such as low kickback chain, chain braking system and special guide bars that reduce the risks associated with kickback.
- Only use replacement bars and chains specified by the manufacturer or the equivalent.
- Never let the moving chain contact any object at the tip of the guide bar.
- Keep the working area free from obstructions such as other trees, branches, rocks, fences, stumps, etc. Eliminate or avoid any obstruction that your saw chain could hit while you are cutting through a particular log or branch.
- Keep your saw chain sharp and properly tensioned. A loose or dull chain can increase the chance of kickback. Check tension at regular intervals with the motor stopped and battery removed.
- Begin and continue cutting only with the chain moving at full speed. If the chain is moving at a slower speed, there is a greater chance for kickback to occur.
- Cut one branch at a time.

- Use extreme caution when re-entering a previous cut. Engage spiked bumpers into wood and allow chain to reach full speed before proceeding with cut.
- Do not attempt plunge cuts or bore cuts.
- Watch for shifting branches or other forces that could close a cut and pinch or fall into chain.

Kickback Safety Features

⚠️ WARNING: The following features are included on your Pole Saw to help reduce the hazard of kickback; however such features will not totally eliminate this dangerous reaction. As a chain saw user do not rely only on safety devices. You must follow all safety precautions, instructions, and maintenance in this manual to help avoid kickback and other forces which can result in serious injury.

- **Reduced-Kickback Guide Bar**, designed with a small radius tip which reduces the size of the kickback danger zone on bar tip. A reduced- kickback guide bar is one which has been demonstrated to significantly reduce the number and seriousness of kickbacks when tested in accordance with safety requirements for electric chain saws.
- **Low-Kickback Chain**, designed with a contoured depth gauge and guard link which deflect kickback force and allow wood to gradually ride into the cutter. A low-kickback chain is a chain which has met kickback performance requirements of ANSI B175.1 when tested on the representative sample of chain saws.

SPECIFIC SAFETY RULES

- **Hold tool by insulated gripping surfaces when performing an operation where the cutting tool may contact hidden wiring.** Contact with a "live" wire will make exposed metal parts of the tool "live" and shock the operator.

⚠️ WARNING: Some dust created by power sanding, sawing, grinding, drilling, and other construction activities contains chemicals known to cause cancer, birth defects or other reproductive harm.

Some examples of these chemicals are:

- lead from lead-based paints,
- crystalline silica from bricks and cement and other masonry products, and
- arsenic and chromium from chemically-treated lumber. (CCA)

Your risk from these exposures varies, depending on how often you do this type of work. To reduce your exposure to these chemicals: work in a well ventilated area, and work with approved safety equipment, such as those dust masks that are specially designed to filter out microscopic particles.

- **Avoid prolonged contact with dust from power sanding, sawing, grinding, drilling, and other construction activities. Wear protective clothing and wash exposed areas with soap and water.** Allowing dust to get into your mouth, eyes, or lay on the skin may promote absorption of harmful chemicals.

⚠ WARNING: Use of this tool can generate and/or disburse dust, which may cause serious and permanent respiratory or other injury. Always use NIOSH/OSHA approved respiratory protection appropriate for the dust exposure. Direct particles away from face and body.

SAVE THESE INSTRUCTIONS

The label on your tool may include the following symbols.

V	volts	A	amperes
Hz	hertz	W	watts
min	minutes	~	alternating current
— — —	direct current	n _o	no load speed
□	Class II Construction	⊕	earthing terminal
⚠	safety alert symbol	.../min	revolutions or per minute

COMPONENTS

Before using your Pole Saw familiarize yourself with all operating and safety features.

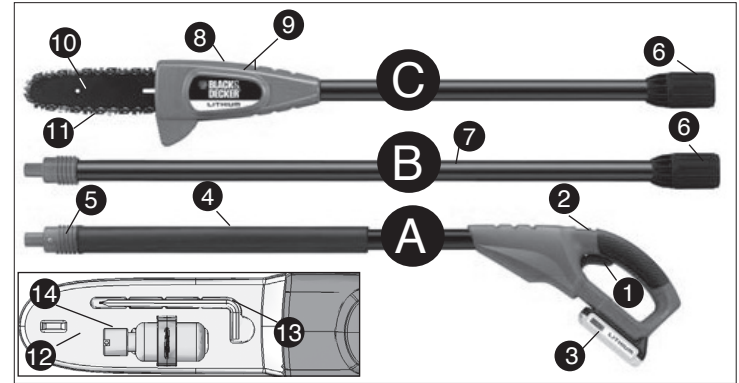

- | | |
|---------------------|-----------------------------------|
| A. Handle Module | 7. Center Extension Pole |
| B. Center Extension | 8. Sprocket Cover (other side) |
| C. Saw Head Module | 9. Allen Head Screws (other side) |
| 1. Trigger Switch | 10. Guide Bar |
| 2. Lock Button | 11. Saw Chain |
| 3. Battery | 12. Scabbard |
| 4. Foam Gripper | 13. Allen Wrench |
| 5. Threaded Pole | 14. Oil Bottle |
| 6. Threaded Sleeve | |

Pole Saw Names and Terms

- **Chain Brake** - A device used to stop the Pole Saw.
- **Drive Sprocket or Sprocket** - The toothed part that drives the saw chain.
- **Guide Bar** - A solid railed structure that supports and guides the saw chain.
- **Guide Bar Scabbard** - Enclosure fitted over guide bar to prevent tooth contact when saw is not in use.
- **Kickback** - The backward or upward motion, or both of the guide bar occurring when the saw chain near the nose of the top area of the guide bar contacts any object such as a log or branch, or when the wood closes in and pinches the saw chain in the cut.
- **Low-Kickback Chain** - A chain that complies with the kickback performance requirements of ANSI B175.1-1991 (when tested on a representative sample of chain saws).
- **Reduced Kickback Guide Bar** - A guide bar which has been demonstrated to reduce kickback significantly.
- **Replacement Saw Chain** - A chain that complies with kickback performance requirements of ANSI B175.1-1991 when tested with specific chain saws. It may not meet the ANSI performance requirements when used with other saws.
- **Saw Chain** - A loop of chain having cutting teeth, that cut the wood, and that is driven by the motor and is supported by the guide bar.
- **Spiked Bumper (Spike)** - The pointed tooth or teeth for use when pruning to pivot the saw and maintain position while sawing.
- **Switch** - A device that when operated will complete or interrupt an electrical power circuit to the motor of the chain saw.
- **Switch Lockout** - A movable stop that prevents the unintentional operation of the switch until manually actuated.
- **Trimming (Pruning)** - Process of cutting limbs from a tree.
- **Undercut** - An upward cut from underside of a log or limb. This is done while in normal cutting position and cutting with top of guide bar.

IMPORTANT SAFETY INSTRUCTIONS FOR BATTERY CHARGERS

SAVE THESE INSTRUCTIONS: This manual contains important safety instructions for battery chargers.

- Before using charger, read all instructions and cautionary markings on charger, battery pack, and product using battery pack.

⚠WARNING: Shock hazard. Do not allow any liquid to get inside charger.

⚠CAUTION: Burn hazard. To reduce the risk of injury, charge only designated **Black & Decker** batteries. Other types of batteries may burst causing personal injury and damage.

⚠CAUTION: Under certain conditions, with the charger plugged in to the power supply, the charger can be shorted by foreign material. Foreign materials of a conductive nature such as, but not limited to, steel wool, aluminum foil, or any buildup of metallic particles should be kept away from charger cavities. Always unplug the charger from the power supply when there is no battery pack in the cavity. Unplug charger before attempting to clean.

- **The charger supplied with this product is intended to be plugged in such that it is correctly orientated in a vertical or floor mount position.**
- **DO NOT attempt to charge the battery pack with any chargers other than the ones in this manual.** *The charger and battery pack are specifically designed to work together.*
- **These chargers are not intended for any uses other than charging designated **Black & Decker** rechargeable batteries.** *Any other uses may result in risk of fire, electric shock or electrocution.*
- **Do not expose charger to rain or snow.**
- **Pull by plug rather than cord when disconnecting charger.** *This will reduce risk of damage to electric plug and cord.*
- **Make sure that cord is located so that it will not be stepped on, tripped over, or otherwise subjected to damage or stress.**
- **Do not use an extension cord unless it is absolutely necessary.**

Use of improper extension cord could result in risk of fire, electric shock, or electrocution.

- **An extension cord must have adequate wire size (AWG or American Wire Gauge) for safety.** The smaller the gauge number of the wire, the greater the capacity of the cable, that is 16 gauge has more capacity than 18 gauge. When using more than one extension to make up the total length, be sure each individual extension contains at least the minimum wire size.

Recommended Minimum Wire Size for Extension Cords

		Minimum Gauge for Cord Sets			
Volts		Total Length of Cord in Feet			
120V		0-25	26-50	51-100	101-150
240V		0-50	51-100	101-200	201-300
Ampere Rating		American Wire Gauge			
More Than	Not more Than				
0	- 6	18	16	16	14
6	- 10	18	16	14	12
10	- 12	16	16	14	12
12	- 16	14	12	Not Recommended	

- **Do not place any object on top of charger or place the charger on a soft surface that might block the ventilation slots and result in excessive internal heat. Place the charger in a position away from any heat source.** The charger is ventilated through slots in the top and the bottom of the housing.
- **Do not mount charger on wall or permanently affix charger to any surface.** The charger is intended to use on a flat, stable surface (i.e., table top, bench top).
- **Do not operate charger with damaged cord or plug — have them replaced immediately.**
- **Do not operate charger if it has received a sharp blow, been dropped, or otherwise damaged in any way.** Take it to an authorized service center.
- **Do not disassemble charger;** take it to an authorized service center when service or repair is required. Incorrect reassembly may result in a risk of electric shock, electrocution or fire.

- **Disconnect the charger from the outlet before attempting any cleaning.** This will reduce the risk of electric shock. Removing the battery pack will not reduce this risk.
- **NEVER attempt to connect 2 chargers together.**
- **The charger is designed to operate on standard household electrical power (120 Volts). Do not attempt to use it on any other voltage.**

SAVE THESE INSTRUCTIONS

IMPORTANT SAFETY WARNINGS FOR BATTERY PACKS

⚠WARNING: For safe operation, read this manual and manuals originally supplied with tool before using the charger.

The battery pack is not fully charged out of the carton. Before using the battery pack and charger, read the safety instructions below. Then follow charging procedures outlined.

READ ALL INSTRUCTIONS

- **Do not incinerate the battery pack even if it is severely damaged or is completely worn out.** The battery pack can explode in a fire. Toxic fumes and materials are created when battery packs are burned.
- **Do not charge or use battery in explosive atmospheres, such as in the presence of flammable liquids, gases or dust.** Inserting or removing the battery from the charger may ignite the dust or fumes.
- **If battery contents come into contact with the skin, immediately wash area with mild soap and water.** If battery liquid gets into the eye, rinse water over the open eye for 15 minutes or until irritation ceases. If medical attention is needed, the battery electrolyte for Li-ion batteries is composed of a mixture of liquid organic carbonates and lithium salts.
- **Contents of opened battery cells may cause respiratory irritation.** Provide fresh air. If symptoms persist, seek medical attention.

⚠WARNING: Burn hazard. Battery liquid may be flammable if exposed to spark or flame.

- Charge the battery packs only in **Black & Decker** chargers.
- **DO NOT splash or immerse in water or other liquids.** This may cause premature cell failure.
- **Do not store or use the tool and battery pack in locations where the temperature may reach or exceed 105°F (40°C) (such as outside sheds or metal buildings in summer).**

⚠WARNING: Never attempt to open the battery pack for any reason. If battery pack case is cracked or damaged, do not insert into charger. Do not crush, drop or damage battery pack. Do not use a battery pack or charger that has received a sharp blow, been dropped, run over or damaged in any way (i.e., pierced with a nail, hit with a hammer, stepped on). Damaged battery packs should be returned to service center for recycling.

⚠WARNING: Fire hazard. Do not store or carry battery so that metal objects can contact exposed battery terminals. For example, do not place battery in aprons, pockets, tool boxes, product kit boxes, drawers, etc., with loose nails, screws, keys, etc. **Transporting batteries can possibly cause fires if the battery terminals inadvertently come in contact with conductive materials such as keys, coins, hand tools and the like.** The US Department of Transportation Hazardous Material Regulations (HMR) actually prohibit transporting batteries in commerce or on airplanes (i.e., packed in suitcases and carry-on luggage) **UNLESS** they are properly protected from short circuits. So when transporting individual batteries, make sure that the battery terminals are protected and well insulated from materials that could contact them and cause a short circuit. **NOTE: LI-ION batteries should not be put in checked baggage.**

STORAGE RECOMMENDATIONS

1. The best storage place is one that is cool and dry away from direct sunlight and excess heat or cold.
2. Long storage will not harm the battery pack or charger.

CHARGING PROCEDURE

The standard charger provided will charge a fully depleted battery in about 4 hours.

1. Plug the charger into an appropriate outlet before inserting the battery pack.

2. Insert the battery pack into the charger as shown in **figure 1**.

3. The green LED will flash indicating that the battery is being charged.

4. The completion of charge is indicated by the green LED remaining on continuously. The pack is fully charged and may be used at this time or left on the charger.

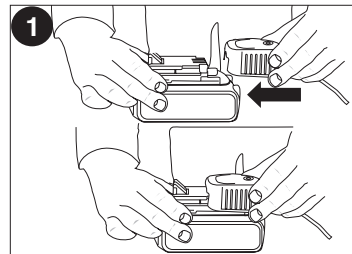

Recharge discharged batteries

as soon as possible after use or battery life may be greatly diminished. It is recommended that the batteries be recharged after each use.

LEAVING THE BATTERY IN THE CHARGER

The charger and battery pack can be left connected with the green LED glowing indefinitely. The charger will keep the battery pack fresh and fully charged.

IMPORTANT CHARGING NOTES

1. Longest life and best performance can be obtained if the battery pack is charged when the air temperature is between 60°F and 80°F (16°- 27°C). **DO NOT** charge the battery pack in an air temperature below +40°F (+4.5°C), or above +105°F (+40.5°C). This is important and will prevent serious damage to the battery pack.
2. The charger and battery pack may become warm to touch while charging. This is a normal condition, and does not indicate a problem. To facilitate the cooling of the battery pack after use, avoid placing the charger or battery pack in a warm environment such as in a metal shed, or an uninsulated trailer.

3. If the battery pack does not charge properly:
 - a. Check current at receptacle by plugging in a lamp or other appliance
 - b. Check to see if receptacle is connected to a light switch which turns power off when you turn out the lights.
 - c. Move charger and battery pack to a location where the surrounding air temperature is approximately 60°F and 80°F (16°- 27°C)
 - d. If charging problems persist, take the tool, battery pack and charger to your local service center.
4. The battery pack should be recharged when it fails to produce sufficient power on jobs which were easily done previously. **DO NOT CONTINUE** to use under these conditions. Follow the charging procedure. You may also charge a partially used pack whenever you desire with no adverse affect on the battery pack.
5. Foreign materials of a conductive nature such as, but not limited to, steel wool, aluminum foil, or any buildup of metallic particles should be kept away from charger cavities. Always unplug the charger from the power supply when there is no battery pack in the cavity. Unplug charger before attempting to clean.
6. Do not freeze or immerse charger in water or any other liquid.

⚠ WARNING: Shock hazard. Do not allow any liquid to get inside charger. *Never attempt to open the battery pack for any reason. If the plastic housing of the battery pack breaks or cracks, return to a service center for recycling.*

INSTALLING / REMOVING BATTERY PACK

⚠ WARNING: *Make certain the lock-off button is engaged to prevent switch actuation before removing or installing battery.*

TO INSTALL BATTERY PACK: Insert battery pack into tool until an audible click is heard (**figure 1a**).

TO REMOVE BATTERY PACK: Depress the battery release button in the back of the battery pack and pull battery pack out of tool (**figure 1b**).

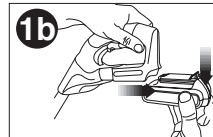
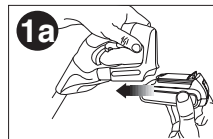

PREPARING YOUR POLE TRIMMER FOR USE

⚠ WARNING: **Read and understand all instructions.** Failure to follow all instructions listed below may result in electric shock, fire and/or serious personal injury.

Installing and Removing Saw Chain

⚠ WARNING: **Sharp moving blade.** To prevent accidental operation, insure that battery is disconnected from the handle before performing the following operations. Failure to do this could result in serious personal injury.

⚠ CAUTION: Sharp moving blade. Always wear protective gloves when installing or removing the chain. The chain is sharp and can cut you when it is not running.

- Place the saw on a firm surface. Rotate the two allen head screws counterclockwise with the wrench provided as shown in **figure 2**.
- Remove sprocket cover, bar clamp, and allen head screws.
- To remove the chain, rotate the screw in the front of the housing using the flat screwdriver end of the wrench as shown in **figure 3**. Turning the screw counterclockwise allows the guide bar to recede and reduces the tension on the chain so that it may be removed.
- Lift the worn chain out of the groove in the guide bar.
- Flip guide bar over.
- To replace the chain, check to make sure that the slot in the guide bar is over the two location pins shown in **figure 3a** and that hole below the slot is located over the adjustment pin.
- Place new chain in groove of guide bar and around sprocket. Make sure saw teeth are facing correct direction by matching arrow on chain with graphic on housing shown here.



- Rotate the screw in the front of the housing clockwise to increase the chain tension as in **Figure 3**.
- Replace sprocket cover, bar clamp, and allen head screws.
- Follow instructions for adjusting the chain tension.

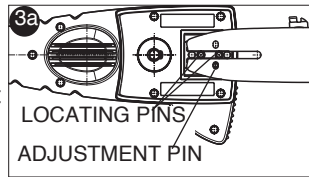
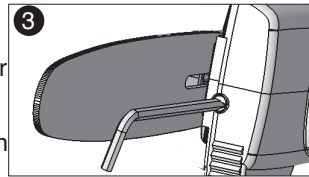
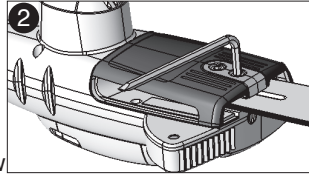

Adjusting Chain Tension

- With the saw still on a firm surface check the chain tension. The tension is correct when the chain snaps back after being pulled 1/8 in. (3mm) away from the chain bar with light force from the middle finger and thumb as shown in **figure 4**. There should be no “sag” between the guide bar and the chain on the underside as shown in **figure 5**.
- To adjust saw chain tension, loosen allen head screws.
- Rotate the screw in the front of the housing using the flat screwdriver end of the wrench as shown in **figure 3**.
- Do not over-tension the chain as this will lead to excessive wear and will reduce the life of the bar and chain. Overtensioning also reduces the amount of cuts you will get per battery charge.
- Once chain tension is correct, tighten allen head screws to clamp bar.
- When the chain is new check the tension frequently (after disconnecting battery) during the first 2 hours of use as a new chain stretches slightly.

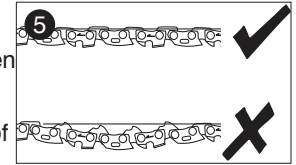
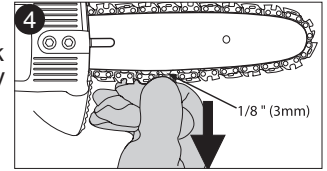

Chain Oiling

- A high quality bar and chain oil or SAE30 weight motor oil should be used for chain and bar lubrication. The use of a vegetable based bar and chain oil is recommended when pruning trees. Mineral oil is not recommended because it may harm trees. Never use waste oil or very thick oil. These may damage your chain saw.
- Lubricate the whole chain evenly before each use as shown in **figure 6**. Also lubricate the chain whenever replacing a fully discharged battery with a fully charged one.

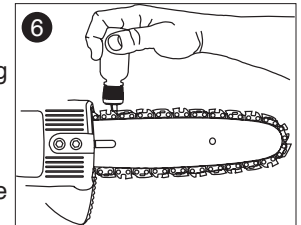

Transporting Pole Saw

- Always remove the battery pack from the handle (**figure 7**) and cover the chain with the scabbard (**figure 8**) when transporting the Pole Saw. See page 8 for additional information on transporting the battery.

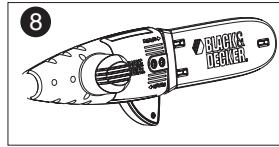
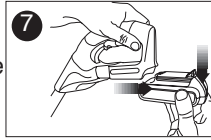

ASSEMBLY

Joining Saw Head Module to Handle Module

⚠ WARNING: Sharp moving blade. To prevent accidental operation, insure that battery is disconnected from the handle and that the protective scabbard is in place on the chain before performing the following operations. Failure to do this could result in serious personal injury.

The three modules which make up the Pole Saw are keyed to insure correct assembly. If a module does not smoothly attach to another do not force fit.

Combining the handle module (A) to the saw head module (C) creates a pole saw that is approximately 6 foot in length as shown in **figure 9**.

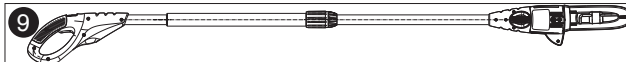

To attach the handle module to the saw head module:

1. Align the **groove** on the **outside** of the coupling end of the handle module (A) with the **tongue** on the **inside** of the coupling end of the saw head module (C). See **figure 10**. Push the two sections completely together.

2. Slide the threaded sleeve (6) **figure 11** on the saw head module down as far as possible and rotate the sleeve clockwise until it stops and completely covers the orange threads as shown in **figure 12**.

⚠ WARNING: Always check to make sure that the sleeve is completely threaded on and that the orange threads are no longer visible. Not threading the sleeve completely on could result in the modules becoming disconnected creating a hazardous condition. Periodically check the connections to insure that no orange threads are visible.

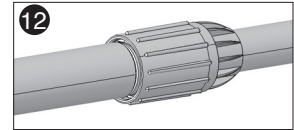
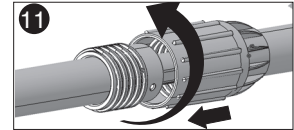
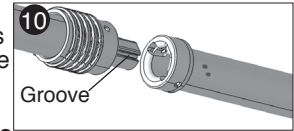

Joining Center Extension to Saw Head Module and Handle Module

Adding the extension (B) to the handle module (A) and saw head module (C) creates a Pole Saw that is approximately 9 foot in length as shown in **figure 13**.



To attach the middle module to the handle module and saw head module:

1. Align the **groove** on the **outside** of the coupling end of the handle module (A) with the **tongue** on the **inside** of the coupling end of the center extension (B). See **figure 14**. Push the two sections completely together.
2. Slide the threaded sleeve (6) (**figure 15**) on the center extension down as

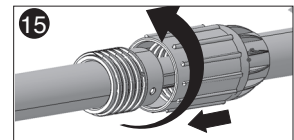
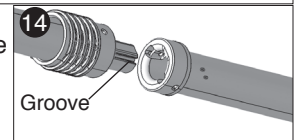

far as possible and rotate the sleeve clockwise until it stops and completely covers the orange threads as shown in **figure 16**.

3. Repeat steps 1 and 2 above to attach the saw head module to the center extension.

⚠ WARNING: Always check to make sure that the sleeve is completely threaded on and that the orange threads are no longer visible. Not threading the sleeve completely on could result in the modules becoming disconnected creating a hazardous condition. Periodically check the connections to insure that no orange threads are visible.

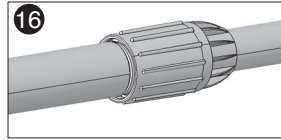

DISASSEMBLY

Detaching Saw Head Module

⚠ WARNING: Sharp moving blade. To prevent accidental operation, insure that battery is disconnected from the handle and that the protective scabbard is in place on the chain before performing the following operations. Failure to do this could result in serious personal injury.

When detaching the modules, whether it is in the two module or three module mode, always detach the saw head module first. To do this, rest the handle module on the ground and grasp the center of the saw head module with one hand **figure 17**. Use your other hand to loosen the threaded sleeve **figure 18** and then pull the two halves apart. Repeat this process if the center extension was attached.

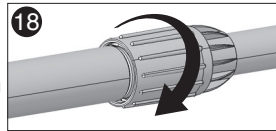
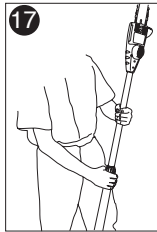

OPERATING THE POLE SAW

⚠ WARNING: Read and understand all instructions. Failure to follow all instructions listed below may result in electric shock, fire and/or serious personal injury.

Connecting the Battery

Place the battery in the tool as shown in **figure 19** and be certain that it is inserted fully into the tool cavity until it “clicks” into place. To remove the battery from the tool, press down on the release button on the back of the battery (**figure 20**) and slide out.

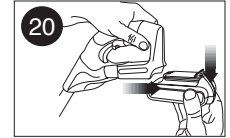
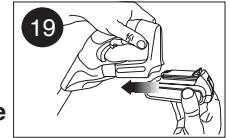

Switch

Always be sure of your footing and grip the Pole Saw firmly with both hands with the thumb and fingers encircling the handle. To turn the tool ON pull the lock button (1) back with your thumb and then squeeze the trigger (2) with your fingers as shown in **figure 21**. (Once the tool is running you can release the lock button.) To turn the tool OFF, release the trigger.

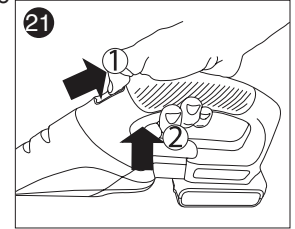

Auto-Stop Chain Braking System

Your chain saw is fitted with an auto-stop chain braking system which will stop the chain quickly each time you release the rear trigger, or if kickback should occur. This system should be tested before every use.

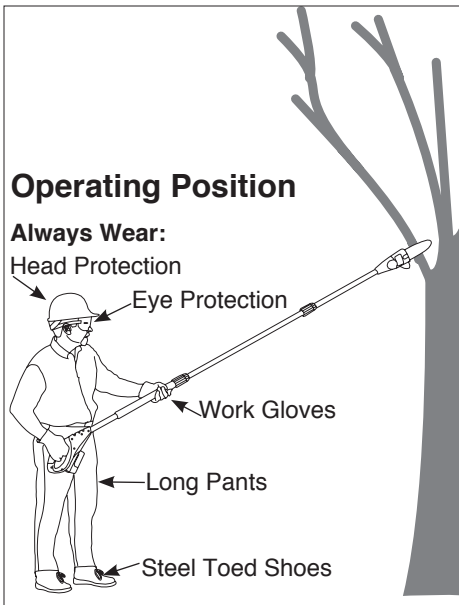

Operating Position

Always Wear:

- Head Protection
- Eye Protection
- Work Gloves
- Long Pants
- Steel Toed Shoes

Pole Saw Trimming / Pruning

⚠️ WARNINGS:

- **Never stand directly under the limb you are cutting.** Always position yourself out of the path of falling debris.
- **Always wear head, eye, foot and body protection.** Wearing body protection helps reduce the risk of injury when operating this unit.
- **Never stand on a ladder or other unstable support while using the Pole Saw.** Always avoid any position which can cause you to lose your balance and cause severe injury.



- **Keep other persons at least 50 feet (15m) from the work area.** Distractions can cause you to lose control.
- **Electrocution Hazard.** To prevent shock, do not operate within 50 feet (15m) of overhead electrical lines. Always check surrounding area for hidden electrical lines.
- **Do not extend Pole Saw switch handle above shoulder height.**

Pruning With the Pole Saw

⚠️ WARNING: When pruning trees:

- **Guard Against Kickback which can result in severe injury or death.** See "KICKBACK", page 4 to avoid the risk of kickback.
- **Do not overreach. Make sure your footing is firm.** Keep feet apart. Divide your weight evenly on both feet.
- **Use both hands to grip Pole Saw as shown in figure 22.** Use a firm grip. Thumbs and fingers must wrap around Pole Saw handle and pole. Keep fingers away from sawdust exhaust chute shown in figure 22a.
- **Never operate while in a tree, in any awkward position or on a ladder or other unstable surface.** You may lose control of Pole Saw causing severe injury.

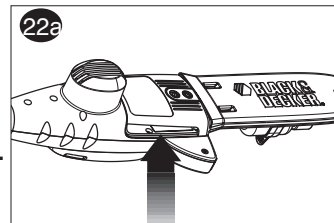

Follow directions below to trim a tree.

1. Make sure Pole Saw is running at full speed before making a cut. When starting a cut, place moving chain against limb. Hold Pole Saw firmly in place to avoid possible bouncing or skating (sideways movement) of Pole Saw.
2. Guide Pole Saw using light pressure. Make first cut six inches from tree trunk on underside of limb. Use top of guide bar to make this cut. Cut 1/3 through diameter of limb. Then make the finish cut from the top as shown in figure 23.

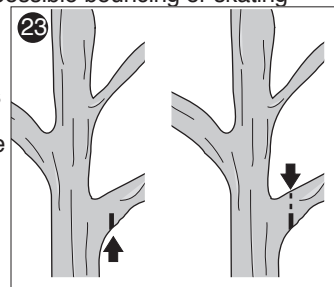

If you try to cut off thick branches from the bottom, the branch may close in and pinch the saw chain in the cut. If you try to cut off thick branches from the top, without a shallow undercut, the branch may splinter **figure 24**.

Do not force Pole Saw. The motor will overload and can burn out. It will do the job better and safer at the rate for which it was intended.

- Remove Pole Saw from cut while it is running at full speed. Stop Pole Saw by releasing trigger. Make sure chain has stopped before setting Pole Saw down.

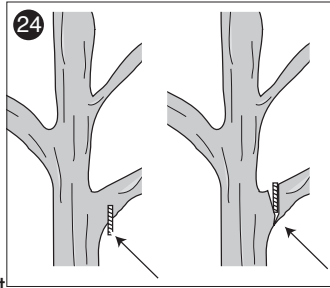

Saw chain sharpness

The cutters will dull immediately if they touch the ground or a nail while cutting.

Saw chain tension

This should be done regularly. Refer to page 10 “Adjusting Chain Tension”.

ACCESSORIES

Replacement chain and bar are available from your nearest Black & Decker service center.

Replacement chain # 623382-00, Replacement bar # 623381-00

The use of accessories not recommended in this manual may be hazardous.

POLE SAW MAINTENANCE SECTION

Regular maintenance ensures a long effective life for the tool. After every 10 minutes of use be sure to remove the battery (be aware the chain and bar can be hot!) check the bar and chain for correct tension and lubricate per pole saw instruction manual.

Use only mild soap and damp cloth to clean the tool. Never let any liquid get inside the tool; never immerse any part of the tool into a liquid.

IMPORTANT: To assure product SAFETY and RELIABILITY, repairs, maintenance and adjustment should be performed by authorized service centers or other qualified service organizations, always using identical replacement parts.

TROUBLESHOOTING

If your Pole Saw does not operate correctly check the following:

Problem	Possible Cause	Possible Solution
<ul style="list-style-type: none"> • Tool will not start. 	<ul style="list-style-type: none"> • Battery not installed properly. • Battery not charged. • Lock-out button not actuated. • Pole connections not properly tightened. 	<ul style="list-style-type: none"> • Check battery installation. • Check battery charging requirements. • Pull back on lock button/actuate trigger. • Refer to instruction manual for pole connections.
<ul style="list-style-type: none"> • Unit will not charge. 	<ul style="list-style-type: none"> • Battery not inserted into charger. • Chain too tight. 	<ul style="list-style-type: none"> • Insert battery into charger until green LED appears. Charge up to 8 hours if battery totally drained.
<ul style="list-style-type: none"> • Bar / chain overheated. 	<ul style="list-style-type: none"> • Lubrication needed. 	<ul style="list-style-type: none"> • Refer to section on adjusting chain tension. • Refer to sections for chain oiling application.
<ul style="list-style-type: none"> • Chain is loose. 	<ul style="list-style-type: none"> • Chain tension set incorrectly. 	<ul style="list-style-type: none"> • Refer to section for chain tensioning.

TROUBLESHOOTING CON'T.

<u>Problem</u>	<u>Possible Cause</u>	<u>Possible Solution</u>
<ul style="list-style-type: none"> Poor cut quality. 	<ul style="list-style-type: none"> Chain tension set incorrectly. Chain needs replacement. 	<ul style="list-style-type: none"> Refer to section on adjusting chain tension. Note: Excessive tension leads to excessive wear and reduction in life of bar & chain. Lubricate after every 10 minutes of use. Refer to section for installation of chain.
<ul style="list-style-type: none"> Unit runs but does not cut. 	<ul style="list-style-type: none"> Chain installed backwards. 	<ul style="list-style-type: none"> Refer to sections for installing and removing chain.

For assistance, visit our website www.blackanddecker.com for the location of the service center nearest you or call the BLACK & DECKER help line at **1-800-544-6986**.

ACCESSORIES

⚠ WARNING: DO NOT use the Hedge Trimmer with any type of accessory or attachment. Such usage might be hazardous.

THE RBRC™ SEAL

The RBRC™ (Rechargeable Battery Recycling Corporation) Seal on the LI-ION battery (or battery pack) indicates that the costs to recycle the battery (or battery pack) at the end of its useful life have already been paid by **Black & Decker**.

RBRC™ in cooperation with **Black & Decker** and other battery users, has established programs in the United States to facilitate the collection of spent LI-ION batteries. Help protect our environment and conserve natural resources by returning the spent LI-ION battery to an authorized **Black & Decker** service center or to your local retailer for recycling. You may also contact your local recycling center for information on where to drop off the spent battery. RBRC™ is a registered trademark of the Rechargeable Battery Recycling Corporation.



SERVICE INFORMATION

All Black & Decker Service Centers are staffed with trained personnel to provide customers with efficient and reliable power tool service. Whether you need technical advice, repair, or genuine factory replacement parts, contact the Black & Decker location nearest you. To find your local service location, refer to the yellow page directory under "Tools—Electric" or call: **1-800-544-6986** or visit www.blackanddecker.com.

FULL TWO-YEAR HOME USE WARRANTY

Black & Decker (U.S.) Inc. warrants this product for two years against any defects in material or workmanship. The defective product will be replaced or repaired at no charge in either of two ways.

The first is to return the product to the retailer from whom it was purchased (provided that the store is a participating retailer). Returns should be made within the time period of the retailer's policy for exchanges (usually 30 to 90 days after the sale). Proof of purchase may be required. Please check with the retailer for their specific return policy regarding returns that are beyond the time set for exchanges.

The second option is to take or send the product (prepaid) to a Black & Decker owned or authorized Service Center for repair or replacement at our option. Proof of purchase may be required. Black & Decker owned and authorized Service Centers are listed under "Tools-Electric" in the yellow pages of the phone directory.

This warranty does not apply to accessories. This warranty gives you specific legal rights and you may have other rights which vary from state to state or province to province. Should you have any questions, contact the manager of your nearest Black & Decker Service Center. This product is not intended for commercial use.

LATIN AMERICA: This warranty does not apply to products sold in Latin America. For products sold in Latin America, check country specific warranty information contained in the packaging, call the local company or see the website for warranty information.

FREE WARNING LABEL REPLACEMENT: If your warning labels become illegible or are missing, call **1-800-544-6986** for a free replacement.

Imported by
Black & Decker (U.S.) Inc.,
701 E. Joppa Rd.
Towson, MD 21286 U.S.A.

See 'Tools-Electric'
– Yellow Pages –
for Service & Sales

