

TOP SURFACE

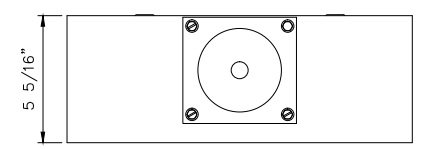

TOP SURFACE

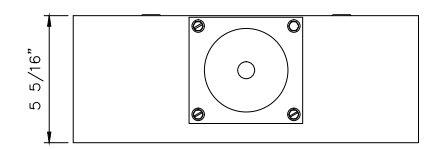

TOP SURFACE

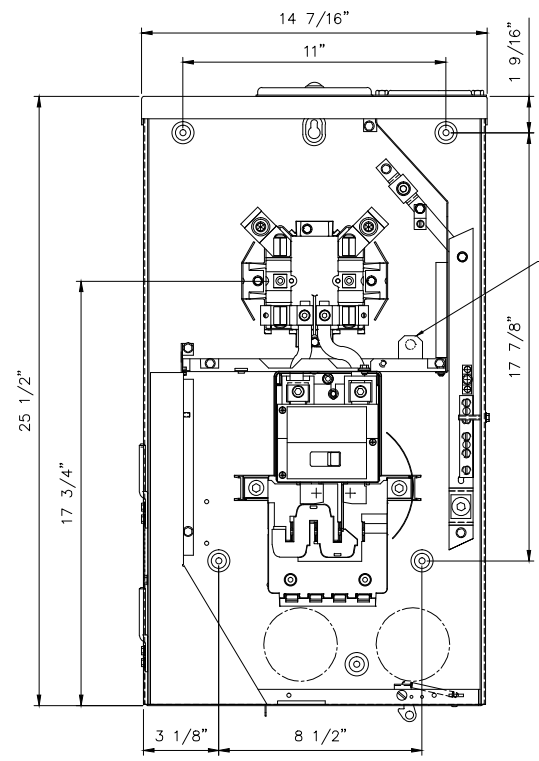

MBT48B125BTS(BL)  
MBT48B150BTS  
MBT48B200BTS(BL)  
MBT48P200BTS

NOTE: CAT NUMBERS WITH "P" DIGIT DENOTE PROVISION ONLY FOR MAIN BREAKER  
CAT NUMBERS WITH "BL" SUFFIX DENOTE PROVISION FOR BARREL LOCK

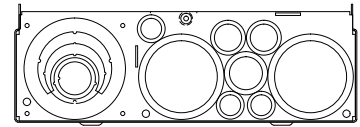

BOTTOM

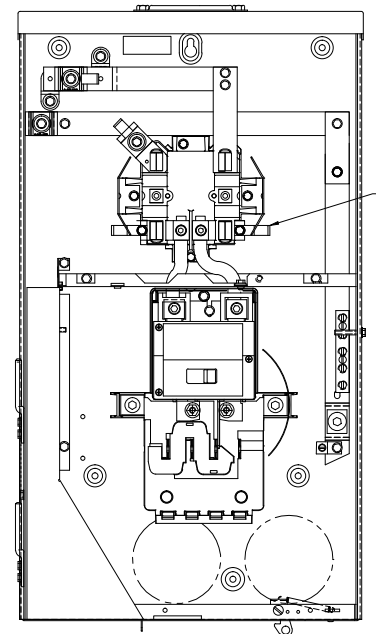

MBT48B200BSAP  
UNDERGROUND FEED ONLY

FACTORY INSTALLED  
HORN BYPASS

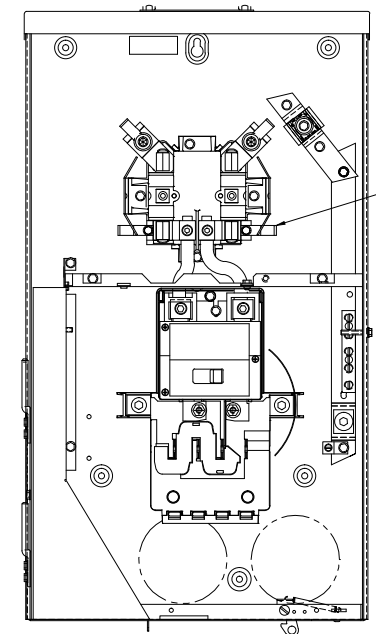

MBT48B200TSAP  
TOP FEED ONLY

FACTORY INSTALLED  
HORN BYPASS

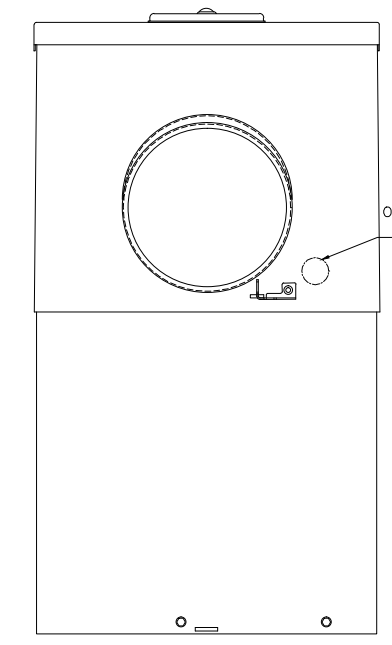

K.O. INCLUDED  
ON "BL" SUFFIX  
UNITS ONLY

TOP ENDWALL (SURFACE)	BOTTOM ENDWALL	QTY.
5/16"	5/16"	3
1/2"	1/2"	3
1/2", 3/4"	1/2", 3/4"	2
3/4", 1"	3/4", 1"	1
1-1/4", 1-1/2", 2, 2-1/2"	1-1/4", 1-1/2", 2, 2-1/2"	2
DS900AP (ADAPTER PLATE)	1-1/2", 2", 2-1/2", 3"	1
HUB PROVISION	KNOCKOUT SIZE	QTY.

CAT. NO.	RANGE	WIRE CONNECTORS		QTY.
		LOCATION		
MBT48B125BTS MBT48B150BTS MBT48B200BTS MBT48P200BTS	#6-350	LINE A & B	2	
	#4-300	LINE N	1	
	#1-300	SUB FEED LUGS	2	
	#6-300	SUB FEED ON NEUT.	1	
	#6-2/0	NEUTRAL BAR	5	
	14-#4	NEUTRAL BAR	2	

CAT. NO.	RANGE	WIRE CONNECTORS		QTY.
		LOCATION		
MBT48B200BSAP (UG) MBT48B200TSAP (TOP)	#6-350	LINE A, B & N	3	
	#1-300	SUB FEED LUGS	2	
	#6-300	SUB FEED ON NEUT.	1	
	#6-2/0	NEUTRAL BAR	5	
	#14-#2	NEUTRAL STRAP	1	

<p>THE INFORMATION ON THIS DRAWING IS DISCLOSED IN CONFIDENCE AND IS NOT TO BE REPRODUCED, USED OR DISCLOSED, EXCEPT FOR THE PURPOSE WHICH FURNISHED.</p>	<p>DATE: 2013/12/23</p>	<p>DESIGNER: L. PORTUONDO</p>	<p>REVISION: 004</p>
<p>FILE DESCRIPTION: METER BREAKER TRAILER PANEL</p>	<p>DATE: 2013/12/23</p>	<p>SCALE: N/A</p>	<p>SHEET: 1 OF 1</p>



96-5933

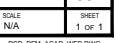

1 OF 1