

A·D·O[®]

INSULATION & BUILDING ACCESSORIES CATALOG

VOLUME 16



PRODUCTS YOU NEED. SERVICE WE DELIVER.

A·D·O[®]

PRODUCTS YOU NEED. SERVICE WE DELIVER.

OUR COMPANY CULTURE



SAFETY

is our number one priority. Care for the well-being of employees, facilities and equipment is essential to responsibly operating a manufacturing and distribution company.



WE WILL FOCUS

on our customers and suppliers to ensure we deliver an outstanding partnership experience every time.



WE WORK

with a **Positive Attitude**, celebrate accomplishments and learn from our mistakes. We remain flexible to changing business conditions.



WE BELIEVE

as a team we are stronger than as individuals. **Teamwork** multiplies our efforts. Open and honest **Communication** between departments and each other is a must for us to win as a team.

PROFESSIONALISM

is the cornerstone in all business relationships. We act with **Integrity** when dealing with each other, our customers and our suppliers. We are **Accountable** for delivering on our commitments and treat everyone with mutual **Respect**.



WE EXPECT

all employees to be **Innovative, Inspirational** and **Lead by Example**. Everyone is accountable for their own personal development. We invest in individual training, which drives personal and professional growth.



ADO VENTS

FOAM

CAULK

TAPE

NETTING & FABRIC

STAPLES

SAFETY & PROTECTIVE

BLOWING

EXTRAS

POLY/FACINGS/VAPOR RETARDER/CHEM/FATICS

PAGES 3-6

PAGES 7-17

PAGES 18-22

PAGES 23-25

PAGES 26-27

PAGES 28-29

PAGES 31-39

PAGES 40-54

PAGES 54-63

PAGES 64-65

ALPHABETICAL INDEX

Air Hose29	Facings.....64	Masks, Moldex.....34	Spray Adhesives.....22
Anchor Adhesive62	Fast Foam7	Masks, Other.....38	Spray Nozzles.....51
Anchor Washers & Dome Caps62	Fireblock Caulk.....18	Mastic22	Staplers & Staples28
Attic Access Covers58	Firestop Caulk18	Mesh Netting.....26	Stilts63
Attic Rulers.....47	Firestop Kit.....38	Moisture Meters.....47	Stud Scrubber.....53
Attic Vents4	Foam7	Moldex Respirators.....34	Suits.....31
Backer Rod56	Foam Saws & Accessories17	Netting.....26	Supplied Air Systems, PAPR.....32
Baffles4	Gloves39	Non-Woven Fabric.....27	Supplied Air Systems.....33
Batt Knives55	Graphite Powder47	Nozzles, Dry Spray41	Tackers.....29
Batt Supports61	Great Stuff Foam13	Nozzles, Wet Spray51	Tape23
Blowing Hoses40	Hammer Tackers29	Plugs50	The Shoot.....16
Blowing Machines42	Handi-Foam.....8	Pneumatic Staplers.....28	Tiger Teeth.....61
Can Light Covers.....60	Hard Hats.....38	Poly.....30	Tool Pouches & Belts.....56
Cardboard Baffle6	Hole Saws & Bits.....48	Protective Suits.....31	Two Component Foam9
Caulk18	Hose Clamps.....41	Provent5	Utility Knives54
Caulk Guns.....21	Hose Reels.....41	Pumps/Motors.....46	Vacuums Bags54
Caulk Warming Bag.....22	Hoses.....40	Pura Insulation Release16	Vacuum Hoses40
Caution Tape56	Husky Plastic Sheeting.....30	Rafter Vents.....4	Vacuums.....52
Chutes.....4	Insulation Anchors62	Recessed Light Covers.....60	Vapor Retarders.....64
Connectors & Reducers41	Insulation Release.....16	Respirators, 3M.....36	Vents4
Curry Combs.....16	Knives, Foam.....17	Respirators, Moldex.....34	Vintool55
Dow Foam.....13	Knives, Utility54	Roof Vents.....59	Visqueen30
Duct Sealant.....22	Lamtec Facings.....64	Saw Blades17	Wall Scrubbers.....53
Durovent.....4	Latex Caulk18	Schematics.....66	Wall Tubing46
Durovent Baffle.....5	Lightning Rods61	Silicone Caulk.....18	Washers & Dome Caps62
Eye Protection35	Manus-Bond.....21	Sill Seal.....57	Water Hoses.....46
Fabric27	Masks, 3M36	Soudal Foam12	Windblock6

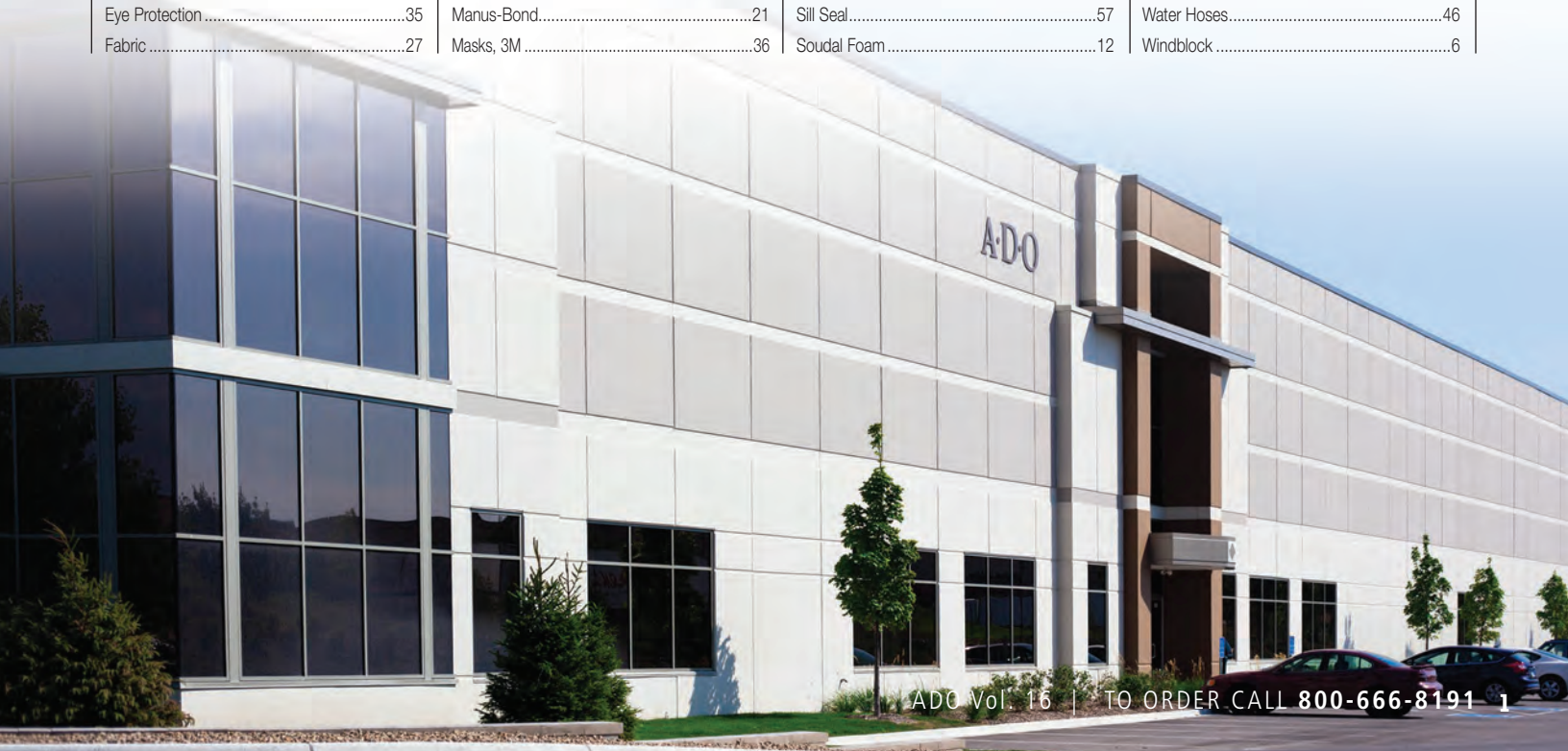



PRODUCTS YOU NEED. SERVICE WE DELIVER.

INSULATION & BUILDING ACCESSORIES CATALOG

To Place an Order

You may conveniently order by phone, fax or email.
Most orders received before 2 pm CST will be shipped the same day.

By Phone: Call 1-800-666-8191

Monday-Friday 7 am- 5 pm CST

By Fax:

Send fax to 1-888-641-3904

By Email:

Send your order to sales@adoproducts.com

ADO Return Policy

ADO will accept returns based on the following conditions:

If the return is a result of an error made by ADO, a carrier, or vendor of ADO, we will gladly replace the item and credit all shipping charges and restock fees. All products that are to be returned MUST have a Return Authorization (RMA) number assigned. To receive an RMA number, please call your ADO Account Manager at 800-666-8191.

All returns must be securely packed in the original packaging, received in resalable condition, and returned within 60 days of original shipment. Returns are subject to a 15% restock fee and return freight charges.

No returns will be accepted on Special Order or Clearance items.

Attic Ventilation Systems



DUROVENT®

The **Number ONE** selling vent in the industry is made of polystyrene for a lightweight air channel that will not absorb water. **Durovent®** is ideal for high volume new construction or lower cost re-insulation.

- Effective and economical way to meet energy code requirements for air flow
- Multiple lengths and perforated center line to fit all applications
- Wide nailing flange and center strut allows for easy installation
- 22" x 48" (50/bag)

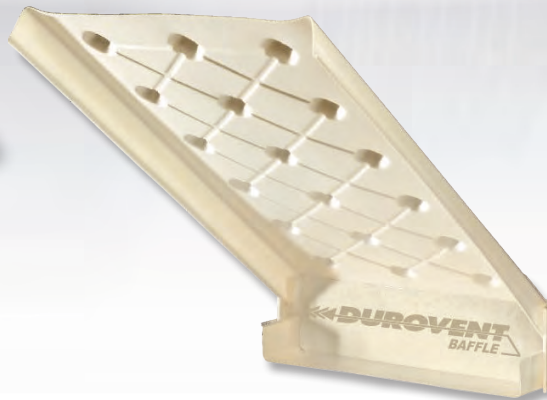

DUROVENT Baffle®

Save both time and money with **Durovent Baffle®**. The baffle is incorporated into our number one selling vent for one-step installation of the vent and baffle. **Durovent Baffle®** is made of the same non-water absorbing polystyrene.

- Most economical way to ventilate while blocking out wind and rain
- Easy positioning and stapling
- Allows for wide range of heel heights
- 23.5" x 46" (50/bag)



proVent®

This top shelf rafter vent is made of Pro Grade tear-resistant high impact polystyrene that will not absorb water. **proVent®** is ideal for jobs that merit premium quality or for difficult applications like re-insulation or getting past existing roofing nails.

- Full joist coverage and maximum airflow
- Allows for a wide range of heel heights
- 14" x 48" and 22" x 48" (100/ctn)

HOW A STATIC ATTIC VENTILATION SYSTEM WORKS

Rafter vents along with soffit and exhaust vents are the components of a Static Attic Ventilation System. Air is introduced into the system through the soffit vents, channeled along the roof deck through a rafter vent and then is expelled through an exhaust vent.

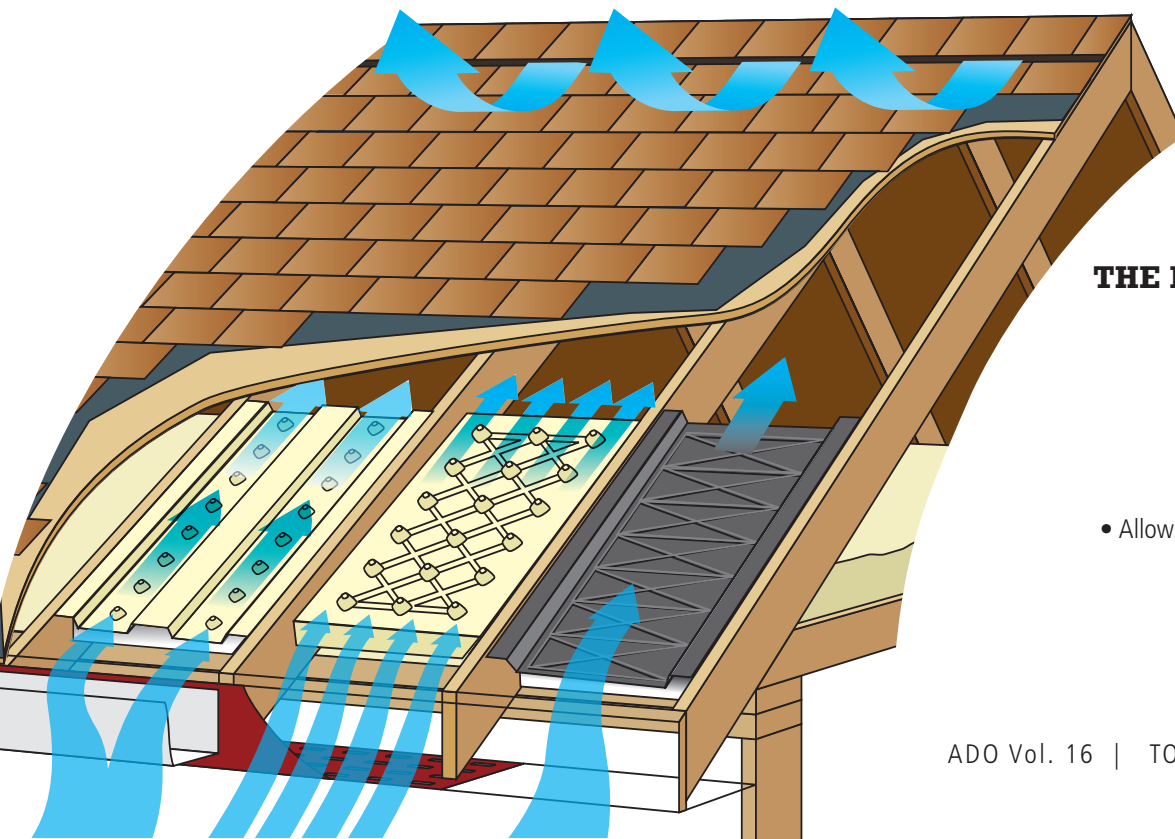

THE BENEFITS ARE MANY.

- Does not absorb water
- Allows for drier attics
- Helps prevent ice-dam formation
- Helps prolong shingle life
- Improves insulation efficiencies
- Allows for cooler attics in summer months

A·D·O®

VENTS

A

DUROVENT®

(A) DUROVENT®

The **Number ONE** selling vent in the industry! The polystyrene material provides a lightweight water resistant air channel. Ideal for high volume new construction or lower cost re-insulation.

- Economical way to meet energy code requirements for air flow
- Multiple lengths and perforated center line to fit all applications
- Wide nailing flange and center strut allows for easy installation

KEY	SKU	DESCRIPTION	PACKAGING	MIN QTY
A	DV2200	Durovent—22" x 48"	50/bag, 1000/pallet	1000
	UDV2248	Durovent w/UPC code—22" x 48"	70/carton, 840/pallet	70
	DV2272	Durovent—22" x 72"	50/bundle, 1000/pallet	1000
	DV2400	Durovent—24" x 48" †	50/bundle, 1000/pallet	1000

†10-day lead time.





DUROVENT® BAFFLE

(B) DUROVENT BAFFLE®

The most economical way to ventilate your roof and block out the wind and rain! A water resistant baffle is incorporated into the **Number ONE** selling vent in the industry allowing for a one-step rafter vent and baffle installation.

- One-step installation
- Easy positioning and stapling
- Allows for wide range of heel heights

KEY	SKU	DESCRIPTION	PACKAGING	MIN QTY
B	DVB2346	Durovent Baffle—23.5" x 46"	50/bag, 1000/pallet	1000
	UDVB2346	Durovent Baffle—23.5" x 46"	70/carton, 840/pallet	70

B



proVent®

(C-D) proVent®

Ideal for premium construction and for difficult applications like re-insulation, proVent may be installed prior to the soffit panel installation without fear of blow-out.

- Made with Pro Grade tear-resistant high impact polystyrene
- Rigid vent construction eliminates breakage during re-insulation
- Full joist coverage for maximum air flow

KEY	SKU	DESCRIPTION	PACKAGING	MIN QTY
C	PV1148	proVent—11" x 48"	200/carton, 2000/pallet	200
	PV1148B	proVent—11" x 48"	3000/bulk pallet	3000
	UPV14480	proVent w/UPC code—14" x 48"	100/carton, 1500/pallet	100
	PV1448B	proVent—14" x 48"	2250/bulk pallet	2250
	PV1448D	proVent—29" x 48" †	1500/bulk pallet	1500
	UPV22480	proVent w/UPC code—22" x 48"	100/carton, 1000/pallet	100
D	PV2248B	proVent—22" x 48"	1500/bulk pallet	1500

†10-day lead time.

D

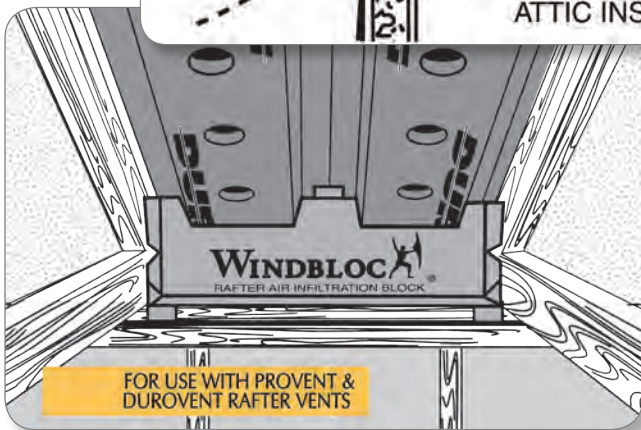
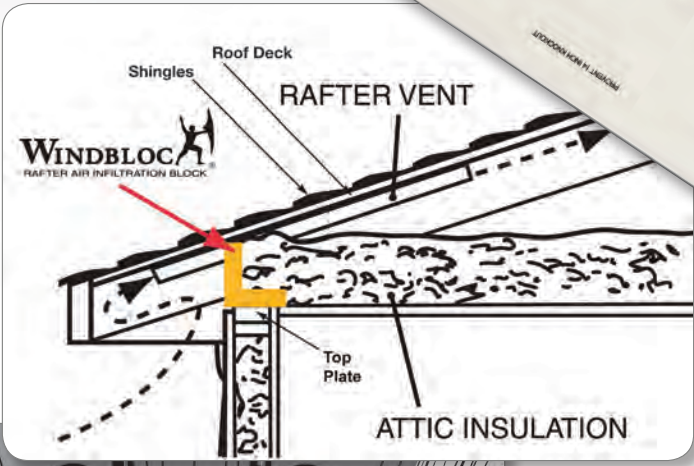
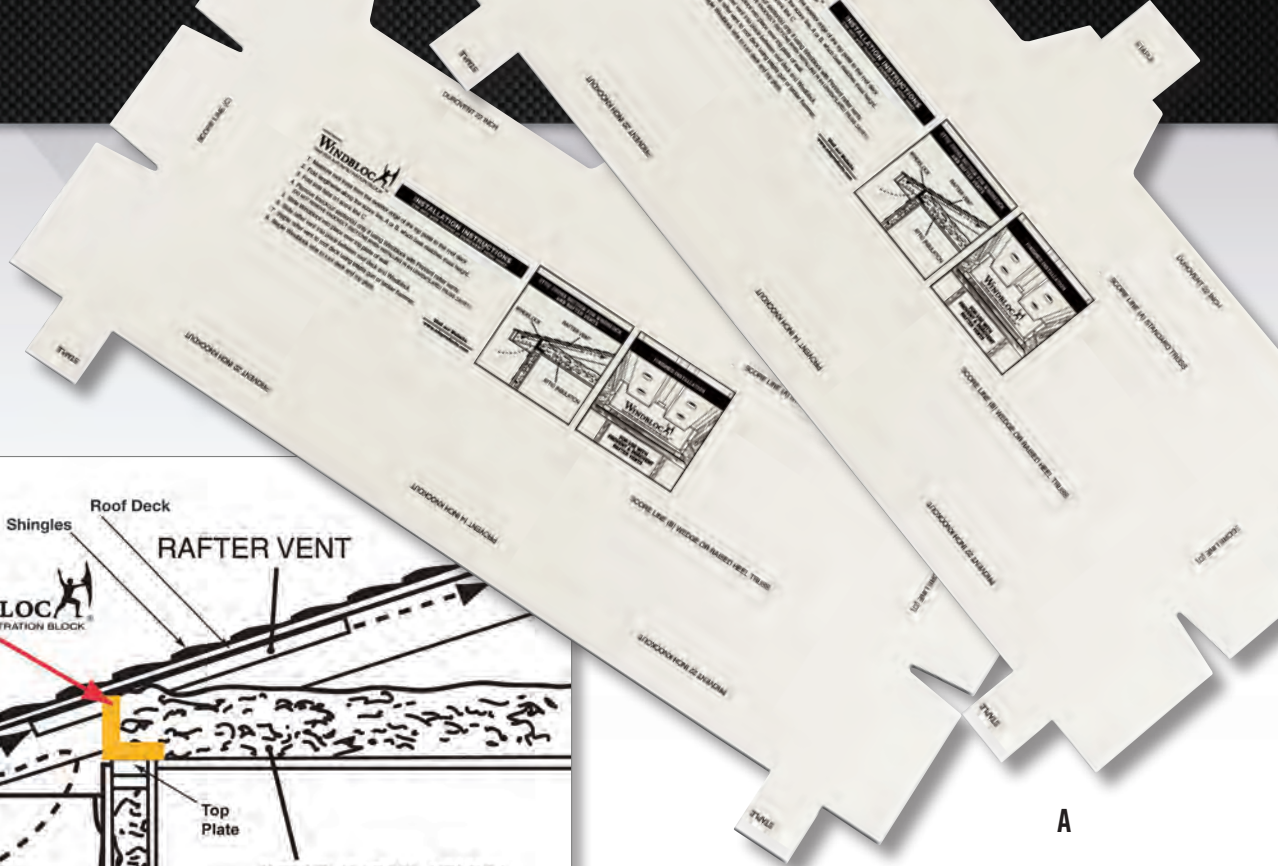

(A) Windblock®

Provides the best moisture and air infiltration seal between the rafter vent and wall top plate. Works with Durovent and proVent to provide a moisture impervious vent and block system.

- Install with rafter vents to maximize attic ventilation performance
- Secures vent in place thus eliminating blow-out during construction
- Blocks moisture from exterior and acts as an insulation stop
- Meets energy code requirements for air infiltration
- Provides a moisture and air infiltration seal between the rafter vent and top of the wall
- Prevents wind driven moisture and cold air infiltration between the rafter vent and the top of the wall
- Reduces energy loss at the attic perimeter
- Effective for use in new and retrofit applications
- Constructed of waterproof and durable polyboard

KEY	SKU	DESCRIPTION	PACKAGING	MIN QTY
A	WB2000	Windblock w/UPC code	200/carton	200

(B) Cardboard Baffles

Cardboard provides an economical vent that is easily installed. The baffle is incorporated into the vent providing a wind barrier to the exterior and an interior block for blowing in attic insulation.

- Flexible material for installing on all joist sizes
- Vent incorporates a 6-9" tail that provides a full cavity block
- Stores flat and is easy to transport and handle

KEY	SKU	DESCRIPTION	PACKAGING	MIN QTY
B	CBCOMBO	Cardboard Baffle—16"/24" x 17"	50/bundle, 1200/pallet	50
	CB1623	Cardboard Baffle—16" x 23"	50/bundle, 1200/pallet	50
	CB2423	Cardboard Baffle—24" x 23"	50/bundle, 1000/pallet	50
	CB2433	Cardboard Baffle—24" x 33"	50/bundle, 600/pallet	50
	CB2444	Cardboard Baffle—24" x 44"	50/bundle, 600/pallet	50

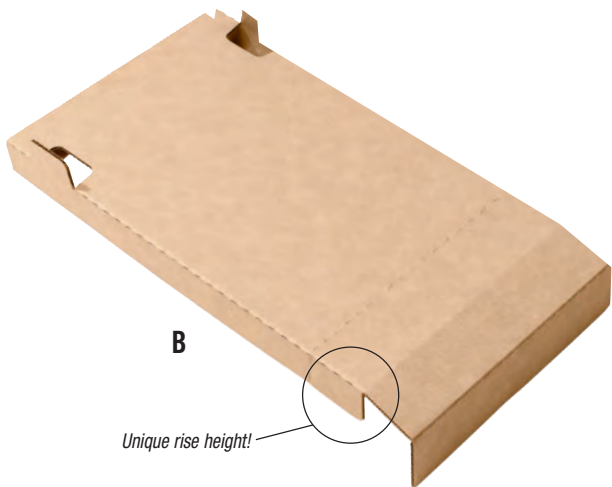

Foam.

FOAM



A

Fast Foam™

Fast Foam™ low pressure one-component polyurethane foam sealants (OCF) are moisture cured and designed to completely fill and seal small gaps, cracks and voids. These polyurethane foam sealants have excellent adhesion and expansion characteristics ensuring a complete and permanent air tight seal.



(A-B) Fast Foam™ Window & Door

Low pressure one-component polyurethane foam sealant (OCF) is a closed cell, AAMA compliant, low pressure window and door foam that will not bow or distort windows or doors.

KEY	SKU	DESCRIPTION	MIN/QTY	CANS/CASE	CASES/PALLET
A	FFWDG	Window & Door Gun — 24 oz can	each	12	48
B	FFWDS	Window & Door Straw Top —12 oz can	each	12	75

(C-D) Fast Foam™ Fireblock

Low pressure one-component orange polyurethane foam sealant (OCF) is a closed cell, low pressure polyurethane foam designed to seal, fill, bond and stop air infiltration. More effective than traditional fireblock materials at blocking the passage of flame and smoke from room to room and floor to floor in residential construction.

KEY	SKU	DESCRIPTION	MIN/QTY	CANS/CASE	CASES/PALLET
C	FFFBG	Fireblock Gun — 24 oz can	each	12	48
D	FFBFS	Fireblock Straw Top —12 oz can	each	12	75

(E) Fast Foam™ Extreme

Fast Foam™ Extreme low pressure one-component polyurethane foam sealant (OCF) is formulated specifically for use in extreme temperatures and cures in temperatures as low as 0° F (-18° C). This product is a closed cell polyurethane foam, intended for use in small gaps, cracks and voids.

KEY	SKU	DESCRIPTION	MIN/QTY	CANS/CASE	CASES/PALLET
E	FFEXG	Extreme Gun — 24 oz can	each	12	48



(A) Handi-Foam® Polyurethane Foam

May be used to seal, fill, bond and stop air infiltration. Designed to seal and fill small cracks, gaps and voids.

KEY	SKU	DESCRIPTION	CANS/CASE	CASES/PALLET
A	P30115	Handi-Foam Gun Foam—24 oz can	12	48

(C) Handi-Foam® Fireblock Polyurethane Foam

Designed to seal, fill, bond and stop air infiltration. Handi-Foam is more effective than traditional fireblock materials at blocking flames and smoke. Recognizable orange color allowing inspectors to easily identify the use of an approved fireblock product. Passes ICC-ES evaluation for use as a fireblock.

KEY	SKU	DESCRIPTION	CANS/CASE	CASES/PALLET
C	P30181	Handi-Foam Fireblock—24 oz can	12	48

(E) Handi-Foam® Black Sealant

One-component polyurethane foam (OCF) sealant specifically designed black in color, making it ideal for applications where product appearance may be a factor. Handi-Foam Black Sealant utilizes a (HC) propellant. May be used to fill gaps and cracks in pond and waterfall design, landscaping, RV undercarriages, crack and hole repair in trees, as well as to seal gaps and penetrations in the building envelope. Fish and plant safe.

KEY	SKU	DESCRIPTION	CANS/CASE	CASES/PALLET
E	P30053	Handi-Foam Black Sealant—12 oz can	12	75

(F) Handi-Foam® Cleaner

Handi-Cleaner is a multi-purpose cleaning agent used to dissolve uncured or fresh polyurethane foam and adhesive, formulated without the use of any ozone-depleting materials.

KEY	SKU	DESCRIPTION	MIN/QTY	CANS/CASE
F	P10083	Handi-Foam Cleaner—12 oz can	can	12

(G-J) Applicator Guns for Handi-Foam

For use with Handi-Foam Single-Component Foam products.

- Reusable
- Adjustable output
- Metal barrel

KEY	SKU	DESCRIPTION	MIN/QTY
G	F61020	Foam Gun, 22" Steel Handi-Tool	each
H	F61030	Foam Gun, Steel Handi-Tool, HT700	each
I	F61039	Foam Gun, Handi-Tool, HT500	each
J	F61050	Foam Gun, Handi-Tool, HT300	each

(K) Extension Tips

Fits Handi-Tool gun models F61050 & F61039.

KEY	SKU	DESCRIPTION	QTY	MIN/QTY
K	E54250	Plastic extension tip— 5 tips/pack	pack	1 pk

(B) Handi-Foam® Extreme Polyurethane Foam

Formulated to work in extreme climates where ambient moisture/humidity is not always present. Tack free within 10 minutes and meet ASTM E-84 Class 1 for caulk and sealants. Handi-Foam® Extreme is the perfect choice for sealing needs in extreme climates.

KEY	SKU	DESCRIPTION	CANS/CASE	CASES/PALLET
B	P30120	Handi-Foam Extreme Gun Foam—24 oz can	12	48

(D) Handi-Foam® Window and Door Polyurethane Foam

Multiple purpose, UL classified, one-component polyurethane foam designed specifically for window and door installation and retro-fit applications. Low pressure formulation will not bow windows or door frames. Expansion is dependent on ambient conditions. Forms a superior air seal that prevents heat loss and noticeable drafts. Handi-Seal provides a higher R-value than open cell polyurethane window and door foam sealants. Meets AAMA (American Architectural Manufacturers Association) test specifications for low pressure window and door sealant foams.

KEY	SKU	DESCRIPTION	CANS/CASE	CASES/PALLET
D	P30272	Handi-Foam Window & Door Foam—24 oz can	12	48

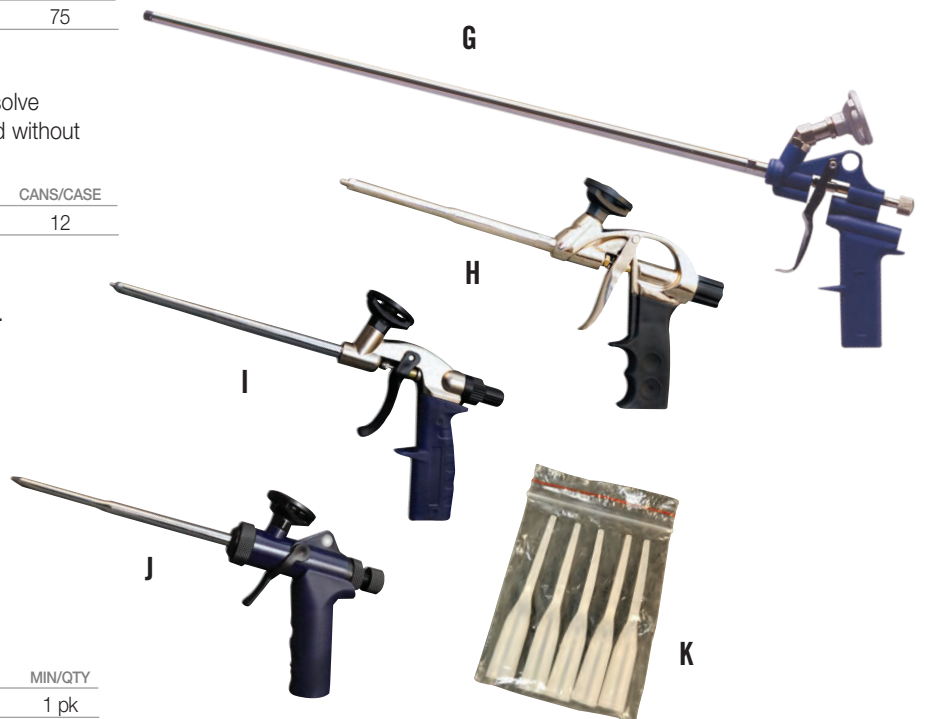

A



B



C



(A) Handi-Foam Channel Fill

High Flow technology is an industry first low pressure polyurethane foam category that takes traditional pour-in-place polyurethane foam and adds the ability to completely fill difficult and intricate voids, making impossible applications possible. Handi-Flow Channel Fill is a stable, chemically cured foam that will not settle, shrink or post expand over time—providing quality assurance that the cavity is and will remain completely filled.

KEY	SKU	DESCRIPTION	MIN QTY	KITS/PALLET
A	P50001	Handi-Foam Channel Fill—15 cu ft.	each	26
	P50002	Handi-Foam Channel Fill—44 cu ft.	each	9

(B-C) E-84 Class 1

Handi-Foam® E84 Class 1 Spray Foam is a low pressure foam system that utilizes a non-flammable blowing agent. Handi-Foam E84 Class 1 Spray Foam has been specifically formulated for flame retardancy and conforms to the requirements of ASTM E84 as a “Class 1(A)” system (flame spread of 25 or less, smoke development of 450 or less). The foam helps to lower heating and cooling costs by drastically reducing energy consumption.

KEY	SKU	DESCRIPTION	MIN QTY	KITS/PALLET
B	HANDI105C1	2-Comp, Handi-Foam, 105 bd ft, Class 1	each	26
B	HANDI205C1	2-Comp, Handi-Foam, 205 bd ft, Class 1	each	26
C	HANDI605C1	2-Comp, Handi-Foam, 605 bd ft, Class 1	each	9

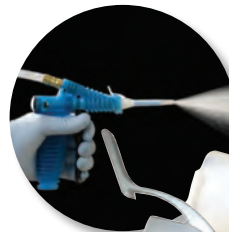

D

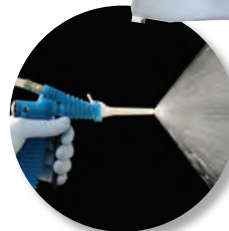

E

New Temperature Warning Technology!

*“When the Nozzle
TURNS BLUE
Stop Your Crew.”™*

HANDI-FOAM ACCESSORIES

(D-F) 2-Component Foam Accessories

KEY	SKU	DESCRIPTION	QTY	MIN/QTY
D	F66170	2-Comp Handi-Foam, Cone Tip Temperature warning nozzle	each	1
E	F66190	2-Comp Handi-Foam, Fan Tip Temperature warning nozzle	each	1
F	F66210	2-Comp Handi-Foam Gun & 15' Hose	each	1
	F65275	Magnum Heated Hose Starter Kit Starter kit includes: F65005: Nitrogen regulator F65090: 6' Nitrogen hose F65100: 6' Nitrogen hose F66171: Cone Nozzle (25 pack) F66191: Fan Nozzle (25 pack) F65301: Refill Tank Pressure Gauge	each	1 kit
	F66220	10" Handi Gun Assembly for refill kits	each	1
	F66265	150' (45m) Magnum HD Heated Hose Assembly		1
	F66181	Handi-Gun Trigger Stop Metering Clip	3/pack	1 pk



F



A

Handi-Foam Spray Polyurethane Foam (SPF)

Handi-Foam's refillable foam systems are chemically cured, two-component spray and pour-in-place polyurethane foam systems, packaged in low pressure refillable cylinders. These systems are designed for larger applications, assembly line filling or any unique application that requires a balance between quality and affordability. Refillable foam systems are available in a variety of sizes and formulations to meet application and market requirements.

The refillable foam systems dispensing equipment utilize the same patented Handi-Gun® as our disposable foam kits, providing accurate and precise dispensing. The addition of the Magnum Heated System® provides improved temperature control and extended reach for increased flexibility.

(A-B) 2 Component Refill Systems

Handi-Foam® Quick Cure Spray Foam Refill Systems are low pressure foam systems that utilize a non-flammable blowing agent to assure the safety of the end-user. Handi-Foam Quick Cure Spray Foam has been specifically formulated for flame retardancy and conforms to the requirements of ASTM E84 as a "Class 2(B)" system (flame spread of 75 or less, smoke development of 450 or less). The foam helps to lower heating and cooling costs by drastically reducing energy consumption.

KEY	SKU	DESCRIPTION	QTY	MIN/QTY
A	P22000	2-Comp Refill 17 Gal 1980 bd ft	each	1 kit
A	P22100	2-Comp Refill 27 Gal 3120 bd ft	each	1 kit
B	P22500	2-Comp Refill 60 Gal 6840 bd ft	each	1 kit
B	P22700	2-Comp Refill 100 Gal 11400 bd ft	each	1 kit

(A-B) E-84 Class 1 Refill Systems

Handi-Foam® E84 Class 1 Spray Foam Refill Systems are low pressure foam systems that utilize a non-flammable blowing agent. HandiFoam E84 Class 1 Spray Foam has been specifically formulated for flame retardancy and conforms to the requirements of ASTM E84 as a "Class 1(A)" system (flame spread of 25 or less, smoke development of 450 or less). The foam helps to lower heating and cooling costs, drastically reducing energy consumption.

KEY	SKU	DESCRIPTION	QTY	MIN/QTY
A	P22070	2-Comp Refill 17 Gal, Class 1, 1980 bd ft	each	1 kit
A	P22270	2-Comp Refill 27 Gal, Class 1, 3120 bd ft	each	1 kit
B	P22470	2-Comp Refill 60 Gal, Class 1, 6840 bd ft	each	1 kit
B	P22670	2-Comp Refill 100 Gal, Class 1, 11400 bd ft	each	1 kit



B



(A-C) Quick Cure

- Designed to fill and insulate large voids and surfaces.
- Ideal for flash and batt or hybrid insulation systems.
- Helps to improve indoor air quality, lowering heating and cooling costs and drastically reducing energy consumption.

KEY	SKU	DESCRIPTION	MIN QTY	KITS/PALLET
A	P10600	2-Comp, Handi-Foam, 12 bd ft †	each	300
B	P10720	2-Comp, Handi-Foam, 205 bd ft †	each	26
C	P10749	2-Comp, Handi-Foam, 605 bd ft †	each	9

† Hazmat shipping charges may apply



(D) Tank Foam Sealant

Multiple purpose, UL classified single component polyurethane foam designed for the professional user. Dispensed through a flexible hose with a valve controlled dispensing nozzle. Optimal application temperature is between 65-100° F (18-38° C), and may be used between 40-115° F (5-46° C). Dries tack-free within 10 minutes or less depending on moisture and temperature conditions. Cuttable within one hour and fully cures in 12-24 hours. Flame spread 25 and smoke developed 50. UL classified file #R13919 Caulking and Sealants. ASTM E-84 (12.5%).

KEY	SKU	DESCRIPTION	KIT	KITS/PALLET
D	HAND110	Foam Tank Handi-Foam —10 lb tank kit	each	60
	HAND116	Foam Tank Handi-Foam —16 lb tank kit	each	40
	F62180	160/260 Hose Assembly (Hose, valve, nozzle)	pack	1 pk





A



B



C



D



(A) Soudal Window & Door Gun Foam

Low pressure formula eliminates windows and doors from bowing. Flame spread 15 and smoke developed 35. UL classified. Soudal Window & Door Foam meets AAMA (American Architectural Manufacturers Association) test specifications for low pressure window and door sealant foams (AAMA 812-04).

KEY	SKU	DESCRIPTION	CANS/CASE	CASES/PALLET
A	116889	Soudal Window/Door Foam—24 oz can	12	54

(B) Soudal Fireblock Gun Foam

Soudal Fireblock gun foam is a one component, self expanding, ready to use, fire block, polyurethane orange-colored foam. It contains CFC-free propellants, which are completely harmless to the ozone layer. See ICC-ES Report #ESR-3118.

KEY	SKU	DESCRIPTION	CANS/CASE	CASES/PALLET
B	120919	Soudal Fireblock Foam—24 oz	12	54

(C) Soudal All Season Gun Foam

Soudal All Season Gun Foam is a top of the line, one component moisture curing polyurethane foam developed especially to perform under difficult freezing temperature conditions where traditional polyurethane foams fail to extrude and cure properly. The foam will extrude at temperatures as low as 14° F (-10° C) and will cure at temperatures as low as -13° F (-25° C) with a can temperature of 41° F (5° C).

KEY	SKU	DESCRIPTION	CANS/CASE	CASES/PALLET
C	455800	Soudal All Season Gun Foam—24 oz can	12	54

(D) Soudal Cleaner for Foam Guns

Environmentally safe agent specially formulated to dissolve non-cured and fresh polyurethane foams from can valves, dispensing equipment, foam guns and clothing. Contains no CFC's.

KEY	SKU	DESCRIPTION	MIN/QTY	CANS/CASE
D	113433	Soudal Cleaner—12 oz can	can	12

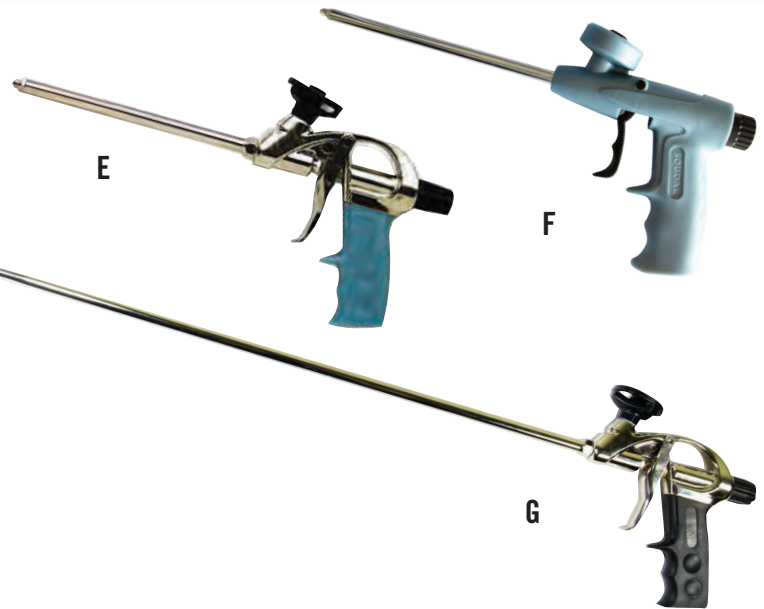

(E-G) Guns for Soudal Foam

These guns are recommended for use with Soudal foam products.

KEY	SKU	DESCRIPTION	MIN/QTY
E	103266	Soudal Designer Gun	each
F	109953	Soudal Compact Gun	each
G	122129	Soudal 24" Long Barrel Gun	each



(A) Great Stuff™ Pro Window & Door Gun Foam



Minimal expanding, single-component, low-pressure formulation and flexible polyurethane foam sealant. Great Stuff Pro Window & Door foam sealant is exclusively formulated to air-seal the gap between a window or door frame and its rough opening. It expands only enough to generate an effective seal, and makes window and door systems more energy efficient. Proven not to bow windows or doors. Conforms to ASTM and AAMA standards. UL classified—flame spread 10 and smoke developed 20.

KEY	SKU	DESCRIPTION	CANS/CASE	CASES/PALLET
A	FOAMWD	Great Stuff Pro Window & Door—20 oz can	12	64

(B) Great Stuff™ Pro Gaps & Cracks Gun Foam

Minimal expanding, single-component foam, recognized as an alternative fireblock penetration sealant. Evaluated by the International Code Council's Evaluation Service, Inc. for use in residential construction. Great Stuff Pro Gaps & Cracks is tinted orange to be more recognizable to building code officials. UL classified—flame spread 15 and smoke developed 20.

KEY	SKU	DESCRIPTION	CANS/CASE	CASES/PALLET
B	FOAMGC26	Great Stuff Pro Gaps & Cracks—30 oz can	12	64

(C) Enerfoam Gun Foam

Premium grade minimal expansion foam with a working temperature range of 25°–120° F. Trimmable in 20 minutes. This closed-cell foam is paintable and waterproof. UL classified—flame spread 15 and smoke developed 20.

KEY	SKU	DESCRIPTION	CANS/CASES	CASES/PALLET
C	ENER4226	Enerfoam—30 oz can	12	64

(D) Great Stuff™ Pro Cleaner for Foam Guns

KEY	SKU	DESCRIPTION	MIN QTY	CANS/CASE
D	ENERCLEAN	Great Stuff Pro Cleaner—12 oz can	can	12



(E-H) Guns for DOW Foam

Recommended for use with Enerfoam and Great Stuff Pro foam. Note: ENER13 & ENER14, and ENERGUN are not recommended for use with other manufacturers' foams.

KEY	SKU	DESCRIPTION	MIN/QTY
E	ENER13	Pro 13 foam gun - Includes tapered tips	each
F	ENER14	Pro 14 foam gun - Includes tapered tips	each
G	122129	24" Long Barrel Gun	each
H	ENERGUN	Pageris Pro 15 foam gun	each

(I) Foam Gun Tip

KEY	SKU	DESCRIPTION	MIN/QTY
I	259200	Foam gun tip for ENER14	each

DOW® TWO-COMPONENT FOAM REFILL SYSTEMS



Standard hoses and gun shown.

(A) Two-Component Spray Foam – Refillable Systems

With 17-120 gallon capacities, you'll always have enough foam to complete the entire project. Save money with refillable canisters.

KEY	SKU	DESCRIPTION	MIN QTY
A	341167	Froth-Pak 17 Gal. A - ISO Refill	each
	345347	Froth-Pak 17 Gal. B - POLYOL Refill	each
	11042106	Froth-Pak 27 Gal. A - ISO Refill	each
B	11042107	Froth-Pak 27 Gal. B - POLYOL Refill	each
	341165	Froth-Pak 60 Gal. A - ISO Refill	each
C	345344	Froth-Pak 60 Gal. B - POLYOL Refill	each
	341168	Froth-Pak 120 Gal. A - ISO Refill	each
	345346	Froth-Pak 120 Gal. B - POLYOL Refill	each

Two-Component Spray Foam – Refillable Systems – CLASS A

KEY	SKU	DESCRIPTION	MIN QTY
A	340334	Froth-Pak 17 Gal. A - ISO Refill	each
	340321	Froth-Pak 17 Gal. B - Class A POLYOL Refill	each
	11042108	Froth-Pak 27 Gal. A - ISO Refill	each
B	11042109	Froth-Pak 27 Gal. B - Class A POLYOL Refill	each
	340337	Froth-Pak 60 Gal. A - ISO Refill	each
C	340323	Froth-Pak 60 Gal. B - Class A POLYOL Refill	each
	340336	Froth-Pak 120 Gal. A - ISO Refill	each
	340322	Froth-Pak 120 Gal. B - Class A POLYOL Refill	each

Froth-Pak™ Refill Accessories

SKU	DESCRIPTION	MIN QTY
158336	Dispenser (gun)	each
158403	30' GHA Kit – includes dispenser, valves, hose, wrench	each
238107	Regulator Kit - requires 7.5' hoses (#158420, below)	each
158428	On/Off Valve, chemical (tank to hose)	each
158432	In-line On/Off Valve (hose to dispenser)	each
158420	7.5' Hose (use for chemical and/or nitrogen, single hose)	each
158421	15' Hose (buy in pairs for both A & B sides of chemicals)	each
158422	30' Hose (buy in pairs for both A & B sides of chemicals)	each
259202	Couplings – ACC fitting 8 JIC (connects hoses)	each
216151	Replacement Tank Filter	each
328507	Arctic Pak Wrap Heated Hose System (controller assembly 150' hose)	each
328508	Arctic Pak Wrap and Controller Assembly (without hoses)	each
328509	Arctic Pak Wrap Controller Only	each
334489	Arctic Pak Replacement Hose Set (A & B side 150' hoses)	each
259207	Calibration Nozzle – Gray back	each
FANTIP	(259215) Fan Spray Tip, Gray back, 6-7 lbs/min.	each
CONETIP	(259218) Cone Spray Tip, Gray back, 6-7 lbs/min.	each
259207M	Calibration Nozzle – White back	each
FANTIPM	Fan Spray Tip, White back, 4 lbs/min.	each
CONETIPM	Cone Spray Tip, White back, 4 lbs/min.	each
259220	Pour Nozzle – Black back	each
368846	Base Starter Kit, Froth Pak Refill	each
Contains: (1) 158403 30' GHA Kit		
(1) - 238107 Regulator Kit		
(2) - 158420 7.5' Hose		
(2) - 216151 Replacement Tank Filter		



(A-C) Two-Component Spray Foam – DOW Froth-Pak™

Two-component polyurethane spray foam that comes in portable kits. Ideal as an insulator and air-sealant, Froth-Pak bonds to most construction materials including lumber, plywood, particleboard, foambord, masonry, metals, drywall, concrete and foam panels. Flame spread of 25 or less. Smoke development of 450 or less. It can be used to fill cavities, wall and floor penetrations, cracks and expansion joints. Includes 15' hose.

KEY	SKU	DESCRIPTION	MIN QTY
A	FROTH12	Froth-Pak two-component kit—12 bd ft	each
B	FROTH180	Froth-Pak two-component kit—200 bd ft †	each
C	FROTH600N	Froth-Pak two-component kit—620 bd ft †	each

† Hazmat shipping charges may apply



(D-G) DOW Froth-Pak™ Accessories

KEY	SKU	DESCRIPTION	MIN QTY
D	GHA15	Froth-Pak Gun & Hose Assembly, 15 ft Hose	each
	GHA30	Froth-Pak Gun & Hose Assembly, 30 ft Hose	each
E	FANTIP	(259215) Fan Spray Tip, Gray back, 6-7 lbs/min.	each
F	CONETIP	(259218) Cone Spray Tip, Gray back, 6-7 lbs/min.	each
G	259220	Pour Nozzle – Black back	each
	FANTIPM	Fan Spray Tip, White back, 4 lbs/min.	each
	CONETIPM	Cone Spray Tip, White back, 4 lbs/min.	each

(H-I) Class 1 Two-Component Spray Foam – DOW Froth-Pak™

Mult-purpose two-component polyurethane froth foam specifically formulated for flame retardancy. It conforms to the requirements of ASTM E-84 as a “Class 1” system (flame spread of 25 or less, smoke development of 400 or less), and is designed to insulate, fill and seal various size voids, deaden sound or reduce vibration.

KEY	SKU	DESCRIPTION	MIN QTY
H	FROTH200C1	PU Foam, 2-Comp, Froth-Pak 210 bd ft (1.75 PCF) Class 1 †	each
I	FROTH600NC1	PU Foam 2-Comp, Froth Pak A & B, 650 bd ft Kit (1.75 PCF), Class 1 †	each

† Hazmat shipping charges may apply



FOAM ACCESSORIES

(A) The Shoot™

The Shoot™ is a patented, effective way to insulate open framed areas in new construction applications of residential and commercial buildings, as well as room additions and remodeling projects. The Shoot™ has been researched and developed to be the perfect tool for the spray foam industry, spray-on systems and blow-in blanket systems. It is 6' in length and manufactured to fit 16" and 24" on center openings. With several scored edges, it can also fit odd sized openings.

KEY	SKU	DESCRIPTION	MIN QTY
A	SH016	The Shoot, 16" X 72", 50/Bundle, 500/Pallet	50
	SH024	The Shoot, 24" X 72", 50/Bundle, 500/Pallet	50

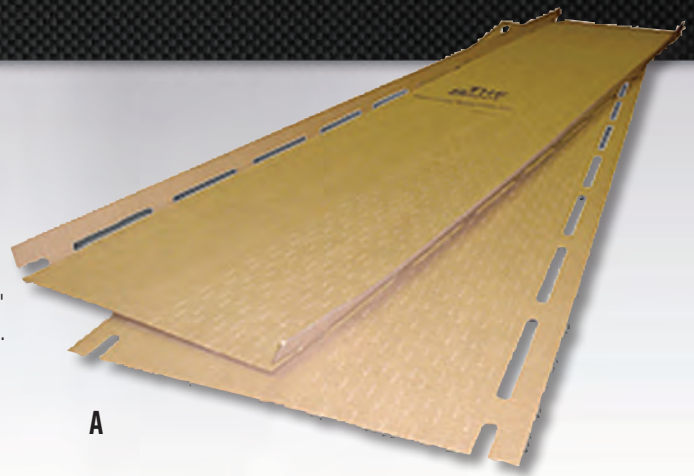

A

(B) 2-Gallon Pail and Spray Foam Cylinder Warming Wrap

Pail warmer will warm a two gallon can or a 200 Bd Ft foam kit cylinder. Made from heavy duty nylon CPAI 84 which creates a heat retaining flexible barrier. Insulated with closed cell polypropylene with an enclosed heating element. Plugs into a 120V AC or 12V DC inverter using a heavy duty industrial cord. Voltage: 120 VAC - 80 Watts

- Velcro closure and elastic top.
- Measures 8" high x 29" long.

KEY	SKU	DESCRIPTION	MIN QTY
B	PWW	Wrap—2-gallon warmer	each

(C) 5-Gallon Spray Foam Cylinder Warming Wrap

This pail warmer will warm a five gallon can or a 620 Bd Ft foam kit cylinder. It is made from heavy duty nylon CPAI 84 which creates a heat retaining flexible barrier. It is insulated with closed cell polypropylene with an enclosed heating element. It plugs into a 120V AC or 12V DC inverter using a heavy duty industrial cord.

- Convenient cord storage pouch on the front
- Velcro closure and adjustable cinch straps for a snug fit
- Measures 11.5" high x 41" long

KEY	SKU	DESCRIPTION	MIN QTY
C	CWW	Wrap—5-gallon warmer	each

(D) 25' Foam Hose for Warming Wrap

To be used with 2 component kit hoses. Cylinder wrap is not included.

KEY	SKU	DESCRIPTION	MIN QTY
D	FHW	Warming Wrap—25' Foam Hose	each

(E) Curry Combs

The curry combs come in a set, one 4" and one 5". These are great tools for scraping/planing 1/2 lb and 2 lb foam from studs as well as foam that is protruding beyond a finished surface.

KEY	SKU	DESCRIPTION	MIN QTY
E	MAC605	Curry Combs, 4" and 5" set	pack

(F) Dental Picks

Dental picks are a great way to clean your spray foam guns as well as your other foam equipment. Made of stainless steel. Sold in packs of 6.

KEY	SKU	DESCRIPTION	MIN QTY
F	MAC604	Spray Foam Dental Picks, 6/pk	pack

(G) Wall Scraper

The Wall Scraper offers more flexibility when it comes to removing excess 1/2 lb or 2 lb spray foam from wall studs and ceiling joists.

KEY	SKU	DESCRIPTION	MIN QTY
G	MAC603	Wall Scraper, 17"	each

(H) Pura Insulation Release

An effective barrier coat to keep overspray of PU foam insulation from adhering to items; spray equipment, tub and shower stalls and other non-porous surfaces. DO NOT apply to personal protective equipment.

KEY	SKU	DESCRIPTION	MIN/QTY
H	PIR1025	Pura Insulation Release—10.25 oz. aerosol can	can



C



D

Image for hose.
Cylinder wrap
sold separately.



G

H

(A) FOAMZALLV18

The FOAMZALLV18 Milwaukee® brand M18 FUEL™ SAWZALL® Reciprocating Saw from Milwaukee Tool is the fastest saw in its class, offering up to 2X more runtime, 30% faster cutting, and 5X longer tool life of competitive saws. The POWERSTATE™ brushless motor provides cutting power that has only been associated with corded tools. The M18™ REDLITHIUM™ XC4.0 Extended Capacity Battery Pack delivers up to 2X runtime and provides more work per charge and more work over the life of the pack than competitive batteries. Comes with (1) M18 FUEL™ SAWZALL® Reciprocating Saw, (2) M18™ REDLITHIUM™ XC 4.0 Extended Capacity Battery Pack, (1) M18™ & M12™ Multi-Voltage Charger and (1) Carrying Case.



KEY	SKU	DESCRIPTION	MIN/QTY
A	FOAMZALLV18	Foam Saw, Foamzall, Battery Powered, 18Vdc	each

(B-C) FOAMZALL

Includes the toughest Milwaukee® brand heavy-duty orbital Sawzall® around, which has a custom coupling to secure a serrated blade intended for trimming 1/2 lb or 2 lb foam. 13 Amp, 120 Vac saw has a 1-1/4" stroke and can provide up to 3,000 strokes/minute. Includes 5 selectable speed control settings, rotating handle that can be locked into 8 different positions every 45° of rotation for optimal operator comfort and orbital or straight reciprocating cut option. Includes carry case. 24-inch and 36-inch 1/2 lb blades and 30-inch 2 lb blades available.

KEY	SKU	DESCRIPTION	MIN/QTY
B	FOAMZALL	Foam Saw, Foamzall, 13 Amp Corded	each
	FOAMZALL15	Foam Saw, Foamzall, 15 Amp Corded	each
C	FZBLADE24	Foam Saw Blade, Foamzall, 24"	each
	FZBLADE	Foam Saw Blade, Foamzall, 36"	each
	FZBLADE2LB	Foam Saw Blade for 2 lb foam, Foamzall, 30"	each

FZBLADE2LB not pictured - blade is white

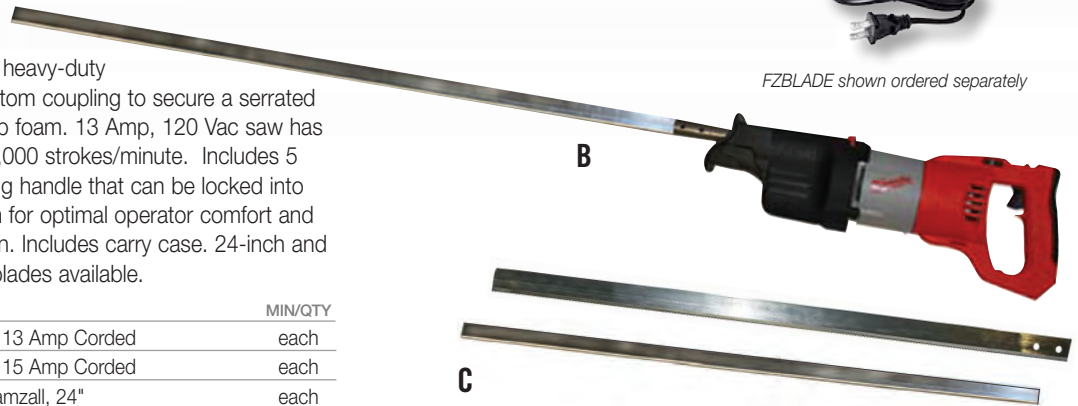

FZBLADE shown ordered separately



Enlarged to Show Blade Detail

(D) Super Shear Foam Saw

Specifically designed for trimming excess polyurethane foam insulation. The Super Shears have been field tested for over seven years and have provided reliability. Powered by a 12 amp electric motor, it eliminates the need for a large onsite air compressor and delivers a quieter cut. Add to that, the ease of being able to cut open or closed cell foam by simply changing blades and you have a versatile saw.

KEY	SKU	DESCRIPTION	MIN/QTY
D	SUPERSHEAR	Foam Saw, Super Shear, 12 amp corded	each
	SSBLADEC	Foam Saw Blade, Super Shear, Closed Cell 18"	each
	SSBLADEO	Foam Saw Blade, Super Shear, Open Cell 26"	each

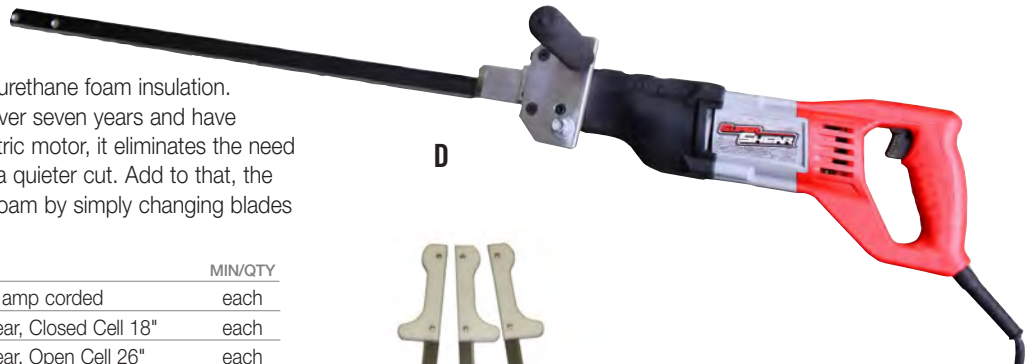

E

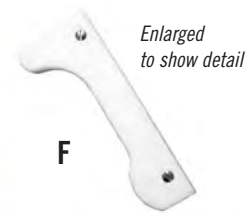

Enlarged to show detail

F



G

(E-G) Foam Saw ISO Knives, Blades and Handles

Both the 36" and 18" ISO Knife are designed for 1/2 lb spray foam removal. Designed with high impact resistant handles specially shaped to reduce the risk of the user's hands accidentally sliding forward across the blade in the event of a sudden stop while cutting.

KEY	SKU	DESCRIPTION	MIN QTY
E	MAC601	Foam Saw, 36" ISO Knives, 3/pk	pack
	MAC601ABLADE	Foam Saw Blade, 36" ISO Blades, 3/pk	pack
F	MAC601BHANDLE	Foam Saw Handle, ISO style, 7", fits 36" and 18" foam saws	each
G	MAC602	Foam Saw, 18" ISO Knives, 3/pk	pack
	MAC602ABLADE	Foam Saw Blade, 18" ISO Blades, 3/pk	pack



(A) Premier XtraBond® 25-year Caulk

XtraBond® 25 is a premium grade multi-purpose acrylic latex sealant formulated to provide excellent adhesion and durability to a wide variety of interior and exterior substrates and applications. White.

- Water Clean Up
- Excellent Paintability
- Easy Gunning & Tooling
- Environmentally friendly

KEY	SKU	DESCRIPTION	TUBES/CASE	CASES/PALLET
A	XB25	Premier XtraBond 25-year—10.1 oz tube	24	80

(B) Premier XtraBond® 50-Year Caulk

XtraBond® 50 is a premium grade multi-purpose siliconized acrylic latex sealant. Manufactured and developed to provide excellent adhesion to vinyl, aluminum, wood, sheet metal and most common building materials without the need of a primer. White.

- Window & Door Approved
- Mildew Resistant
- Excellent Flexibility
- Paintable
- Clean Up with Water
- Cures rapidly

KEY	SKU	DESCRIPTION	TUBES/CASE	CASES/PALLET
B	XB50W	Premier XtraBond 50-year—10.1 oz tube	24	80

(C) Premier XtraBond® Intumescent Firestop

XtraStop™ 550 is designed for filling areas around wires, vents, pipes, ducts and other wall penetrations & construction voids. Water based sealant and can be used wherever ASTM E-814 Specification is needed.

- Non Combustible
- Bonds to most Materials
- Non Toxic
- Non-Sag
- Withstand 3000 Degrees
- ASTM E-814 - 8 hours

KEY	SKU	DESCRIPTION	TUBES/CASE	CASES/PALLET
C	550XS	Premier XtraBond Intumescent Firestop Red—10.1 oz tube	24	80

(D) Fire Seal FS136

FIRE SEAL is tested to meet and exceed ASTM-E136 and ASTM-E814 standards for fireblocking/firestopping single-family residential construction. Fire Seal possesses superior adhesion and freeze-thaw characteristics and is the contractors' #1 choice for fireblocking non-rated wood-frame construction. Fire Seal will not shrink, crack, or crumble upon cure. Fire Seal creates an air-tight barrier to prevent passage of flames, smoke, and toxic gases from spreading area to area within concealed spaces.

KEY	SKU	DESCRIPTION	TUBES/CASE	CASES/PALLET
D	CLKFS136	Fire Seal 136 Fireblock 10.3 oz tube	12	120



FIRE SEAL Specifications:

- Tested to ASTM-E814 (UL 1479)
- Tested to ASTM-E136
- UL Classified
- CPVC Compatible
- For Single Family, Non-Rated Penetrations
- Red color
- V.O.C. Content = < 1 g/l



(A) Boss 357 Acrylic Painter's Caulk

20-Year acrylic latex caulk designed for both interior and exterior use. Adheres well to wood, masonry, brick, and plaster. Available in white.

KEY	SKU	DESCRIPTION	TUBES/CASE	CASES/PALLET
A	CLK15	Boss 357 20-year caulk—10.1 oz tube	12	108

(B) Boss 360 Sealant Siliconized Painter's Caulk

30-Year siliconized latex caulk designed for both interior and exterior use. Forms a tough, resilient bond to most building material surfaces. It has excellent resistance to water, weathering, and cures to produce a flexible seal that is non-yellowing and paintable. Available in white.

KEY	SKU	DESCRIPTION	TUBES/CASE	CASES/PALLET
B	CLK25	Boss 360 30-year caulk—10.1 oz tube	12	108

(C) Boss 363 Acrylic Latex Caulk with Silicone

50-Year acrylic latex caulk with silicone that is designed for both interior and exterior use. Forms a tough, resilient bond to most building material surfaces. It has excellent resistance to water, weathering, and cures to produce a flexible seal that is non-yellowing and paintable.

KEY	SKU	DESCRIPTION	TUBES/CASE	CASES/PALLET
C	CLK4501	Boss 363 50-year caulk White—10.1 oz tube	12	108
	CLK4500	Boss 363 50-year caulk Clear—10.1 oz tube	12	108

(D) Boss 365 75-Year 100% Acrylic Elastomeric Latex w/Silicone

Boss 365 100% Acrylic Elastomeric Adhesive/Sealant with Silicone is mildew resistant, rust inhibited and paintable. Can be used for both interior and exterior applications such as crown molding, chair rails, baseboards and all exterior trim. Cures to a tough, flexible seal that is non-yellowing.

- Specifically formulated for high joint movement
- Smooth, creamy consistency makes it easy to tool

KEY	SKU	DESCRIPTION	TUBES/CASE	CASES/PALLET
D	CLK36501	Boss 365, Elastomeric, white—10.1 oz tubes	12	108





(A) Boss 139 Fire Mortar

Low cost, non-combustible fireplace mortar that passes ASTM E-136 and has been tested to 3000°F. Can also be used in residential firestop applications where the building code calls for a non-combustible material.

- Ideal for sealing fireplaces and wood burning stoves

KEY	SKU	DESCRIPTION	TUBES/CASE	CASES/PALLET
A	CLK139	Boss 139 fire mortar, black—10.1 oz tube	12	108

(B) Boss 136 Fireblock Draftstop Sealant

Single component fire rated sealant and non-combustible filler caulking. Used in the annular space around wires, pipes, ducts, vents, cable lines and other penetrations to the building envelope. Applicable standards include: UBC page 1-387, 1997 edition, CABO section 602.7 item 4, 1995 edition, BOCA (NBC) 704.4.1.1 1996 and ASTM E-136.

KEY	SKU	DESCRIPTION	TUBES/CASE	CASES/PALLET
B	CLK136	Boss 136 firestop/draft sealant—10.1 oz tube	12	108

(C) Boss 816 Intumescent Firestop Sealant

Single component, non-sag, water-based sealant and smoke seal that is easy to apply and clean up. Prevents the spread of toxic gases, water, smoke and fire through joint openings. Meets ASTM E-814 (UL 1479), standard test method for fire tests of through-penetration firestops. Conforms to BOCA National Building Code (1996), CABO one and two family dwelling code (1995), Uniform Building Code (1997). See UL Fire Resistance Directory for a list of systems established for Boss 816.

KEY	SKU	DESCRIPTION	TUBES/CASE	CASES/PALLET
C	CLK816	Boss 816 intumescent—10.1 oz tube	12	108

(D) Boss 125 Multi-Seal Construction Sealant

Formulated to offer outstanding primerless adhesion to most common building materials including vinyl, aluminum, steel, concrete, wood and glass. It can be applied and tooled under most weather conditions. This sealant is paintable with most latex base paints. 10.1 oz tube.

KEY	SKU	DESCRIPTION	TUBES/CASE	CASES/PALLET
D	CLK12503	Boss 125 Sealant, Grey	12	108
	CLK12515	Boss 125 Sealant, Bronze Medium	12	108
	CLK12520	Boss 125 Sealant, Bronze Special	12	108
	CLK12501	Boss 125 Sealant, White	12	108
	CLK12502	Boss 125 Sealant, Black	12	108
	CLK12518	Boss 125 Sealant, Stone	12	108
	CLK12519	Boss 125 Sealant, Translucent	12	108

(E) Boss 348 Multi-Purpose Construction Adhesive

Dual-purpose adhesive to be used with most types of plastic foams and paneling, eliminating the need to purchase two adhesives. This product is not a contact adhesive, meaning it will allow repositioning of panels for up to 20 minutes.

KEY	SKU	DESCRIPTION	TUBES/CASE	CASES/PALLET
E	CLK348	Boss Adhesive—10.1 oz tube	12	108

(F) Boss 380 Contractors Silicone Sealant

100% Silicone caulk provides a weather and waterproof seal, with ozone, UV & radiation and extreme temperature protection. Suitable for your general construction applications. Fills and seals gaps around windows, doors, vents, fixtures and lights.

KEY	SKU	DESCRIPTION	TUBES/CASE	CASES/PALLET
F	CLKS100	Boss 380 Sealant—10.1 oz tube, clear	12	108
	CLKS101	Boss 380 Sealant—10.1 oz tube, white	12	108



A



B



C



D

(A-B) Albion B-Line Cartridge Guns, 12:1 Drive

Engineered with the professional in mind. Features Albion's Double-Gripping Plate technology for double the life of the tool and adjustable wear compensation device for no-loss trigger motion.

- 12:1 thrust ratio
- Ladder hook pull
- Smooth action
- Cartridge puncture tool
- Comfortable grip

KEY	SKU	DESCRIPTION	MIN QTY	QTY/CASE
A	AB12	Pint Cartridge Gun	each	12
B	AB12Q	Quart Cartridge Gun	each	6

(C-D) Albion Viper Cartridge Guns, 6:1 Drive

State-of-the-art design make these tools value leaders. The convenient built-in spout cutter and puncture tool make for simple operation.

- 6:1 Thrust Ratio
- Ladder hook pull
- Ratchet Caulk Gun
- Cartridge puncture tool

KEY	SKU	DESCRIPTION	MIN QTY	QTY/CASE
C	AR6B	Pint Cartridge gun	each	24
D	AR6BQ	Quart Cartridge Gun	each	24



E

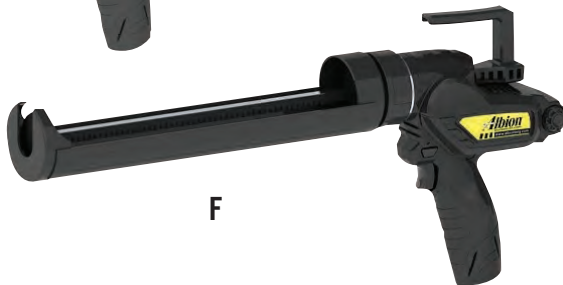

F

(E-F) Albion Electric Caulk Guns

Electric Quart Cartridge Gun has 400 lbs of dispensing force. Variable speed trigger with max speed dial and auto reverse for no-drip.

- Lightweight
- Ladder hook pull
- Lithium ion battery
- Battery fuel gauge
- Fast 30-minute recharge
- Includes 12V Li-Io battery and charger

KEY	SKU	DESCRIPTION	MIN QTY
E	AE12	Electric Pint Cartridge Gun, 12V	each
F	AE12Q	Electric Quart Cartridge Gun, 12V	each



G



(G) Manus-Bond 50-AC Acoustical Sealant

Non-drying butyl, synthetic rubber-based sealant for reducing sound and vapor transmission in partition systems. It remains flexible for a long-lasting, resilient, and acoustical seal. Conforms to CAN/CGSB 19.21 M87.

KEY	SKU	DESCRIPTION	TUBES/CASE	CASES/PALLET
G	C52A01	Manus-Bond—29 oz tube, White	12	32
	C52A02	Manus-Bond—29 oz tube, Black	12	32

CAULK ACCESSORIES

(A-B) Spray Adhesives

Fast tacking and high bond strength product for a wide variety of substrates. Capable of handling virtually any light or heavy duty job. VOC Complaint, fast drying, high strength web spray.

KEY	SKU	DESCRIPTION	CANS/CASE	CASES/PALLET
A	SA5017	Intertape Spray Adhesive, 12 oz cans	12	105
B	SA635	BOSS Spray Adhesive, 12 oz cans	12	75



(C) Caulk Warming Bag

This bag is designed to keep your caulk warm in cold weather.

- Heavy duty waterproof nylon construction
- Low energy consumption
- Plugs into 120 VAC or 12 VDC Inverter SKU #75WI*
- Retains heat when unplugged

KEY	SKU	DESCRIPTION	MIN QTY
C	CWB	Caulk Warming Bag	each

*Power Inverter sold separately. See SKU 75WI, see below.

(D) Caulk Warmer Bag Saver Sleeves

Caulk Warmer Bag Saver Sleeves help to keep the inside of the bag clean and retains heat when item is out of the warmer. Simply slide over your caulk tube or caulk gun to keep the inside of your caulk warmer clean.

The Caulk Warmer® holds 12 standard size caulk tubes, or 7 quart size tubes, or 12 sausage size tubes, or 7 cans of foam.



(E) Water Based Duct Sealant

A fiber reinforced, water based, premium quality, UL Listed, high velocity duct sealant for commercial and residential supply and return air duct use. Used for sealing joints, seams, and duct wall penetrations on metal air duct; for sealing connections on flexible duct or fiberglass duct board, and is recommended up to 15 inches water column pressure.

- LEED qualified, ZERO VOC's
- Non flammable
- 2-Year shelf life

KEY	SKU	DESCRIPTION	MIN QTY
E	DP1030G	Duct Sealant, 1 gallon—Gray	each
	DP1030W	Duct Sealant, 1 gallon—White	each

(F) 12 VDC 100 Watt Inverter for Caulk and Cylinder Warmer

Provides overload protection, over voltage protection and over temperature protection. Additional uses include digital cameras, mobile phones, and notebook computers. The Power Inverter is the solution to using electricity in your automobile.

- Convert DC to AC
- Continuous power 100W—maximum power of 140W



KEY	SKU	DESCRIPTION	MIN QTY
F	75WI	12 VDC 100 Watt Inverter	each



(A) White Sheathing Tape

Sheathing tape designed for sealing and joining house wrap seams in polyethylene films. Made of high tensile strength polypropylene with acrylic adhesive. Application temperatures of 0° F to 110° F.

KEY	SKU	DESCRIPTION	ROLLS/CASE	CASES/PALLET
A	TS2WH36	2" x 55 yd, White Sheathing Tape	36	56

(B) White Sheathing Tape

Sheathing tape made of polyester film, single coated with an aggressive acrylic adhesive. Aggressive, tacky adhesive aides in splicing to various non-silicone surfaces. Excellent balance of tack, peel and tensile strength. Maintains adhesion at low temperatures. Exhibits excellent aging and weathering properties. Pinked edges for easy tear. Minimum application temperature 0° F. Special order only.

KEY	SKU	DESCRIPTION	ROLLS/CASE	CASES/PALLET
B	TS3WH16P	2.85" x 55 yd, White Sheathing Tape, Pinked	16	72

White Sheathing Tape

Polyethylene film, single coated with a rubber pressure sensitive adhesive. Low-residue aggressive adhesive which bonds well to most surfaces over a wide temperature range. Pinked edges for easy tearing. Operating temperature range of 32° F ~ 160° F.

KEY	SKU	DESCRIPTION	ROLLS/CASE	CASES/PALLET
-	TS4WH12P	3.78" x 60 yd, White Sheathing Tape, Pinked	12	36

(C) Red Sheathing Tape

Constructed of a 1.5 mil polypropylene film with excellent tensile strength. Designed for permanently sealing or repairing a variety of surfaces over a wide range of temperatures and moisture conditions. Product possesses an aggressive acrylic adhesive bonding strength.

KEY	SKU	DESCRIPTION	ROLLS/CASE	CASES/PALLET
C	TS2R36	2" x 55 yd, Red Sheathing Tape	36	56
	TS2R12	2" x 55 yd, Red Sheathing Tape	12	160

(D) Red Sheathing Tape

The pressure sensitive adhesive (PSA) is aggressive and permanently tacky at room temperature when applied using light pressure to the substrate. The Polyester (PET) backing which gives the tape excellent mechanical characteristics and high resistance to moisture, solvents, oil and various chemicals. Pinked edges for easy tear. Application temperatures of 0° F to 110° F.

KEY	SKU	DESCRIPTION	ROLLS/CASE	CASES/PALLET
D	TS3R16	2.85" x 55 yd Red Sheathing Tape, Pinked	16	36

(E) Blue Masking Tape

This low-tack high quality blue painters tape removes cleanly without adhesive transfer or surface damage.

KEY	SKU	DESCRIPTION	ROLLS/CASE	CASES/PALLET
E	TPT14ICP	2" x 60 yd, Low Tack Blue Masking Tape	24	60

(F) Aluminum Foil Tape

Aluminum foil tape is ideal for sealing joints and seams against moisture and vapor on foil jacketing insulation. Tape has soft aluminum foil with acrylic adhesive and protected by an easy release liner. Suitable for many other permanent sealing, holding or masking applications requiring the protection offered by a foil backing. Service temperature -22° F ~ +248° F. Application temperature +23° F ~ +104° F.

KEY	SKU	DESCRIPTION	ROLLS/CASE	CASES/PALLET
F	TF25024	2" x 50 yd, Aluminum Foil Tape	24	36
-	TF25012	2" x 50 yd, Aluminum Foil Tape	12	128
-	TF35016	3" x 50 yd, Aluminum Foil Tape	16	72

TAPE

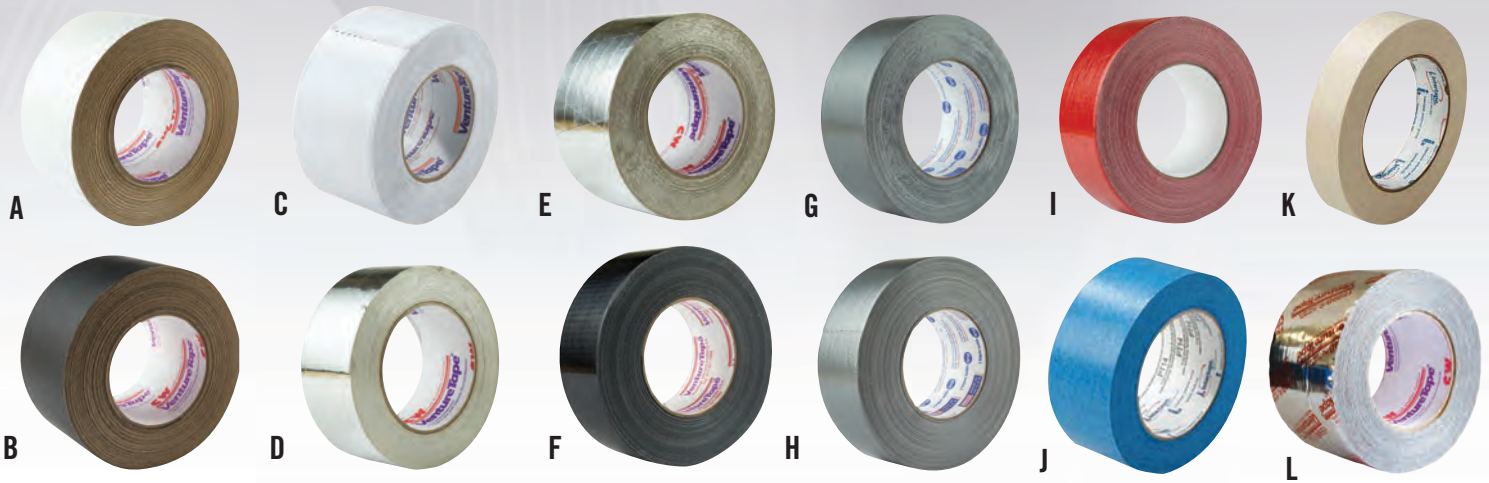

(A-B) Venture Polypropylene Facing Tape

Tri-directionally reinforced UL listed white polypropylene/scrim/kraft lamination. Quick-stick in all weather conditions. 3" rolls.

KEY	SKU	DESCRIPTION	ROLLS/CASE	CASES/PALLET
A	TP350C	3" x 50 yd - White Lamtec WMPVR	16	27
B	TP350CB	3" x 50 yd - Black WMPVR	16	27
	TP1531B	3" x 50 yd - Black WMP10	16	27

(C) Venture Embossed Vinyl Tape

Thin but strong premium white vinyl tape is shrink resistant. Used for seaming vinyl faced fiberglass insulation and for water heater blanket installation. 3" rolls.

KEY	SKU	DESCRIPTION	ROLLS/CASE	CASES/PALLET
C	HJ100C	3" x 50 yd	16	27

(D) Venture Foil Tape

UL classified, 2 mil with high tack adhesive. Superior conformability for sealing insulation and foil-faced sheathing. 2" and 3" rolls.

KEY	SKU	DESCRIPTION	ROLLS/CASE	CASES/PALLET
D	TF250C	2" x 50 yd	24	36
	TF350C	3" x 50 yd	16	36

(E) Venture FSK Tape

6.5 mil tape is foil and fiberglass, scrim laminate designed for sealing scrim faced duct insulation. Used where extra strength beyond regular foil tape is needed. 3" and 4" rolls.

KEY	SKU	DESCRIPTION	ROLLS/CASE	CASES/PALLET
E	TK350C	3" x 50 yd	16	27
	TK450	4" x 50 yd	12	27

(F) Venture Black Duct Tape

Versatile duct tape works well for vapor sealing, sheet metal ductwork and general purpose heavy duty service. Black

KEY	SKU	DESCRIPTION	ROLLS/CASE	CASES/PALLET
F	TD1501B	Venture Duct 2" x 60 yd - Black	24	27

(G) Intertape Utility Grade Duct Tape

Utility grade 8 mil poly-coated cloth-backed tape with a very aggressive adhesive. Has good conformability and is water resistant.

KEY	SKU	DESCRIPTION	ROLLS/CASE	CASES/PALLET
G	TD15	8 mil—1-7/8" x 60 yd	24	27

(H) Intertape Contractor Grade Duct Tape

Contractor grade 11 mil all-purpose duct tape with a natural rubber adhesive, aggressively bonds to almost any surface. Water resistant. Choose TD36 when high performance counts. UL723 rated, meets HUD and BOCA codes.

KEY	SKU	DESCRIPTION	ROLLS/CASE	CASES/PALLET
H	TD36	11 mil—1-7/8" x 60 yd	24	27

(I) Intertape All-Purpose Red Duct Tape

All-purpose 9 mil red duct tape with a natural rubber adhesive with excellent adhesive properties. Water resistant. Used for color coding, critical location marking or a variety of repair projects.

KEY	SKU	DESCRIPTION	ROLLS/CASE	CASES/PALLET
I	TD20R	9 mil—1-7/8" x 60 yd	24	27

(J) Blue Painters Tape

High quality blue tape with a special adhesive that can cleanly be removed even from glass that has been left in direct sunlight for up to 14 days. Excellent UV resistance, conformability and tensile strength.

KEY	SKU	DESCRIPTION	ROLLS/CASE	CASES/PALLET
J	TPT14	Painters Tape—2" x 60 yd	24	36

(K) Intertape Utility Grade Masking Tape

Utility grade 5.1 mil masking tape for non-critical securing and bundling applications. A very comfortable backing with an aggressive adhesive.

KEY	SKU	DESCRIPTION	ROLLS/CASE	CASES/PALLET
K	TM200	5.1 mil—1-7/8" x 60 yd	24	27

(L) Polymer Film Pressure Sensitive Tape

2.5 mill self-wound polymer film is designed to meet the stringent requirements of the Underwriters Laboratories standards UL181. The standards and the application are as follows: UL 181B, Closure Systems for Use with Flexible Air Ducts and Air Connectors; used to seal closures in flex duct and to seal flex duct vapor retarders to duct board. Use - UL 181BFX tape. Tape is for 181B applications only, and is not to be used for 181A applications.

KEY	SKU	DESCRIPTION	ROLLS/CASE	CASES/PALLET
L	360POLY3SIL	3" x 360'	16	27

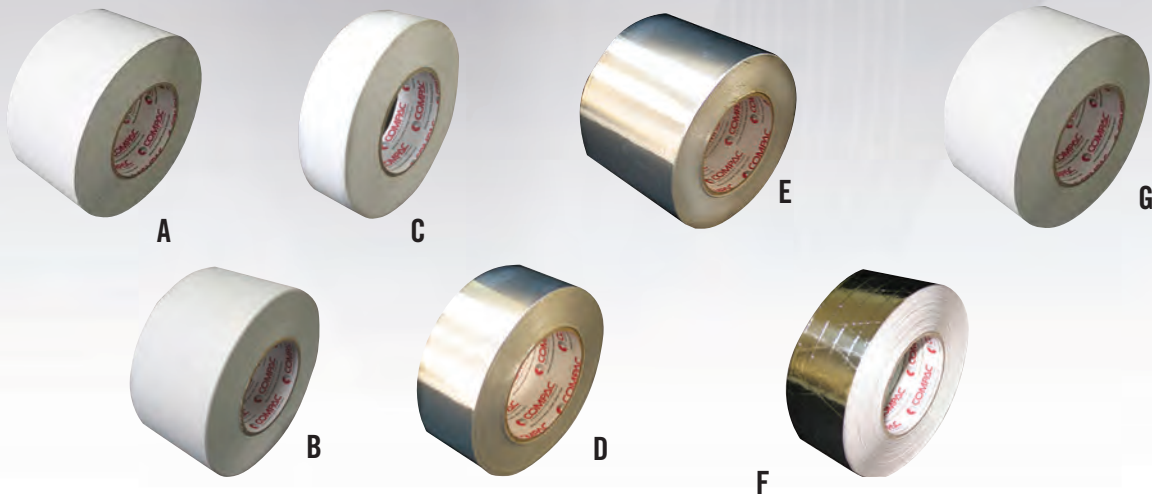

(A) PSK (Poly-Scrim-Kraft) Tape UL Classified

Venture PSK tape is used for seam sealing and patching of PSK faced metal building insulation and other insulation applications where PSK facing is used. PSK has a white film outer surface.

- Can also be used on Lamtec WMP-10 and WMP-30 facing.
- Service temperatures of 0° F to 150° F (-18° C to 66° C)
- Application range of 10° F to 120° F (-12° C to 49° C)

KEY	SKU	DESCRIPTION	ROLLS/CASE	CASES/PALLET
A	280WHTPSK3	3" x 150'	16	27

(B) ASJ (All Service Jacket) Tape UL Classified

Compac #105 ASJ insulation tape is used for seam sealing and patching of ASJ-faced mechanical insulation systems, providing a matching appearance and vapor retarder integrity.

- Service temperatures of 0° F to 150° F (-18° C to 66° C)
- Application range of 10° F to 120° F (-12° C to 49° C)

KEY	SKU	DESCRIPTION	ROLLS/CASE	CASES/PALLET
B	105ASJ3	3" x 150'	16	27

(C) Double Coated/SSL Tape Polyester Carrier UL Classified

Compac #250 double coated/SSL (Self-Seal Lap) tape is used to seal vapor retarder or facing overlap seams on mechanical and other types of insulation. It can also be used to apply patches or to hang vapor retarders or facings on structural members

- Service temperatures of 0° F to 150° F (-12° C to 66° C)
- Application range of -10° F to 120° F (-23° C to 49° C)

KEY	SKU	DESCRIPTION	ROLLS/CASE	CASES/PALLET
C	250DC15	1.5" x 180'	32	27

(D) 1.5 Mil Aluminum Foil Tape UL Classified

Compac #118 foil tape is used for seam sealing and patching of FSK-faced duct wrap insulation, board insulation and other insulation applications where FSK or foil facing is used, providing a matching appearance and vapor retarder integrity.

- Service temperatures of -25° F to 250° F (-32° C to 121° C)
- Application range of 10° F to 120° F (-12° C to 49° C)

KEY	SKU	DESCRIPTION	ROLLS/CASE	CASES/PALLET
D	118FOIL2	2" x 150'	24	36
	118FOIL3	3" x 150'	16	36

(E) 2 Mil Aluminum Foil Tape UL Classified

Compac #120 foil tape is used for seam sealing and patching of foil and FSK-faced duct wrap and board insulation and other insulation applications where FSK or foil facing is used, providing a matching appearance and vapor retarder integrity.

- Service temperatures of -25° F to 250° F (-32° C to 121° C)
- Application range of 10° F to 120° F (-12° C to 49° C)

KEY	SKU	DESCRIPTION	ROLLS/CASE	CASES/PALLET
E	120FOIL2	2" x 150'	24	36
	120FOIL3	3" x 150'	16	36
	120FOIL4	4" x 150'	12	36

(F) FSK (Foil-Scrim-Kraft) Tape UL Classified

Compac #110 FSK tape is used for seam sealing and patching of FSK-faced duct wrap insulation and other insulation applications where FSK facing is used, providing a matching appearance and vapor retarder integrity.

- Service temperatures of 0° F to 150° F (-18° C to 66° C)
- Application range of 10° F to 120° F (-12° C to 49° C)

KEY	SKU	DESCRIPTION	ROLLS/CASE	CASES/PALLET
F	110FSK2	2" x 150'	24	27
	110FSK3	3" x 150'	16	27
	110FSK4	4" x 150'	12	27

(G) PSK (Poly-Scrim-Kraft) Tape VR-10 Type UL Classified

Compac #282 VR-10 PSK tape is used for seam sealing and patching of VR-10 faced metal building insulation and other insulation applications where VR-10 facing is used. VR-10 has a white film outer surface.

- Can also be used on Lamtec WMP-VR facing.
- Service temperatures of 0° F to 150° F (-18° C to 66° C)
- Application range of 10° F to 120° F (-12° C to 49° C)

KEY	SKU	DESCRIPTION	ROLLS/CASE	CASES/PALLET
G	282PSKVR103	3" x 150'	16	27

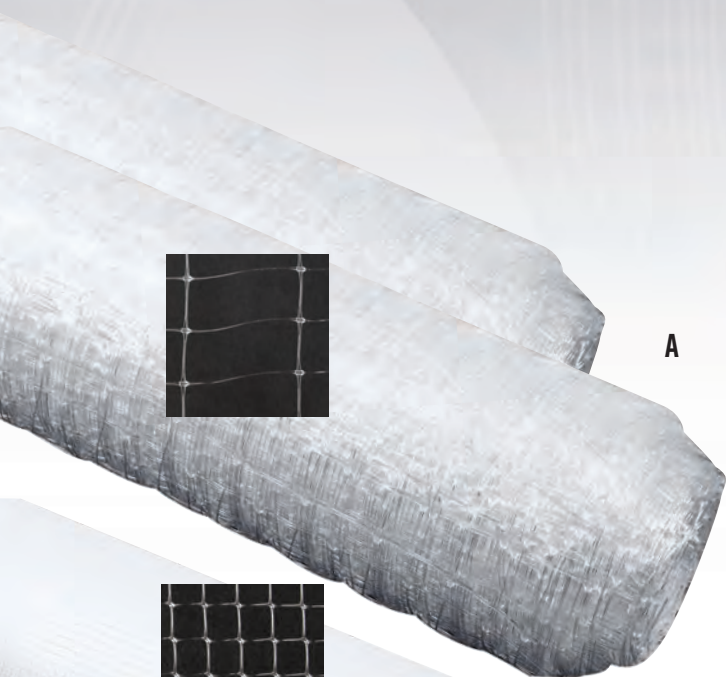
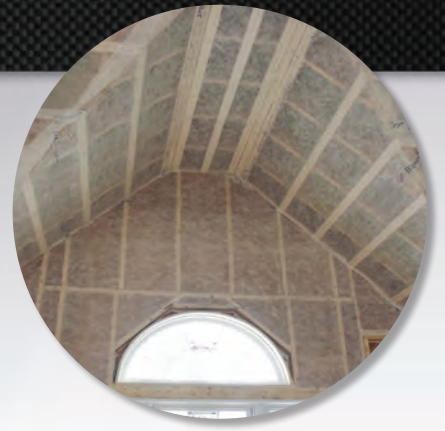

A

NETTING & FABRIC

(A) Economy 1" x 2" Mesh

A great replacement for wire batt hangers!

KEY	SKU	DESCRIPTION	MIN QTY	ROLLS/CASE	CASES/PALLET
A	NT1250	4' x 250'	1 roll	20	4

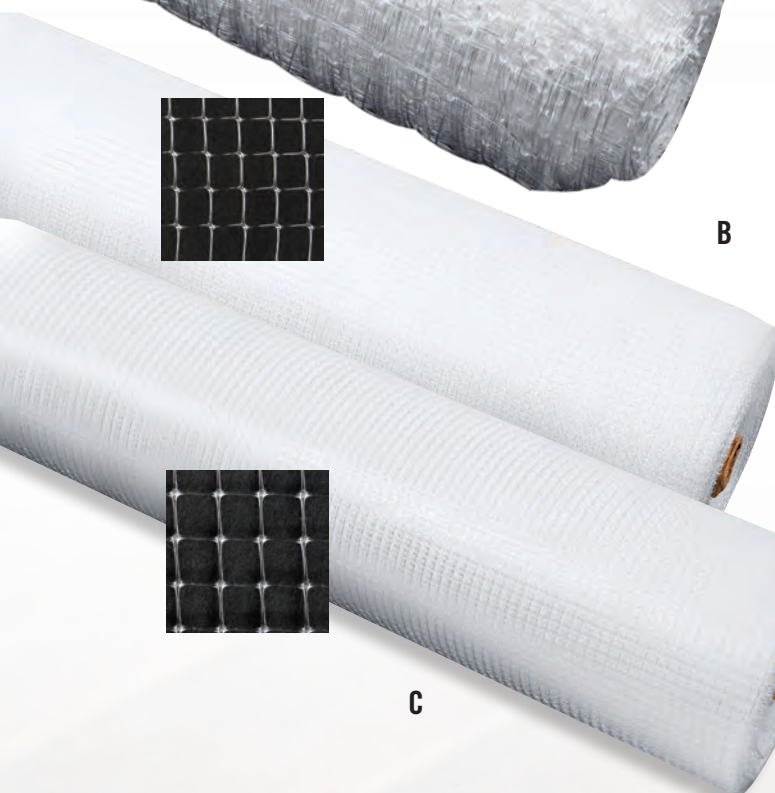

B

(B) Light Duty 1/6" Mesh

Works well for walls when installing cellulose or fiberglass, as a backer to hold wet spray, and as a temporary face before installing drywall.

KEY	SKU	DESCRIPTION	MIN QTY	ROLLS/CASE	CASES/PALLET
B	NT6250	4' x 250'	1 roll	16	4
	NT6125	8' x 125'	1 roll	16	4
	NT62502	2' x 250'	1 roll	32	4

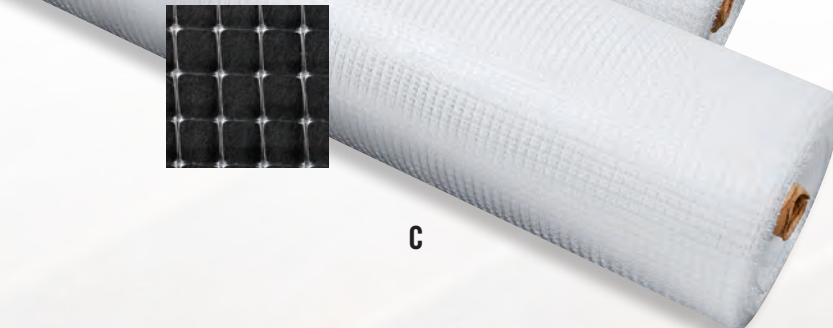

C

(C) Medium Duty 1/4" Mesh

A good choice where greater strength is required and for fireproofing spray applications.

KEY	SKU	DESCRIPTION	MIN QTY	ROLLS/CASE	CASES/PALLET
C	NT4250	4' x 250'	1 roll	9	4
	NT4125	8' x 125'	1 roll	9	4
	NT111	111" x 250'	1 roll	4	8
	NT120	120" x 250'	1 roll	4	8



(A) ADO Pro Pac

ADO Pro Pac is ideal for knee walls, sound walls and many other applications. Keep your job site dust levels down to a minimum. Our best value, high quality non-woven netting is made of 100% polypropylene point bonded material. Rolls are folded for greater convenience when moving quickly through the job site installation. ADO Pro Pac is not the preferred fabric for wet/damp spray installations - See line (D) ADO Pro Web SKUs for this application.

KEY	SKU	DESCRIPTION	MIN QTY	ROLLS/BAG	ROLLS/PALLET
A	ICPP50	4' 2" x 750'	1 roll	1	24
	ICPP100	8' 4" x 750', folded	1 roll	1	12
	ICPP110	9' 2" x 750', folded	1 roll	1	12
	ICPP122	10' 2" x 375', folded	1 roll	1	12

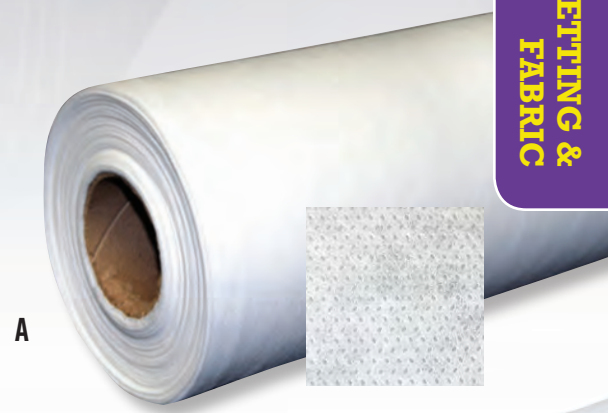

(B) ADO Pro Wall

ADO Pro Wall 40 (Basis Weight 1.18 oz per sq yard) fabric is ideal for knee walls, ceilings, sound walls and many other applications. Keep your job site dust free. Made of 100% polyester.

KEY	SKU	DESCRIPTION	MIN QTY	ROLLS/BAG	ROLLS/PALLET
B	PW408750	8' x 750', folded	1 roll	1	12
	PW409375	9' x 375', folded	1 roll	1	12
	PW409750	9' x 750', folded	1 roll	1	12
	PW4010375	10' x 375', folded	1 roll	1	12
	PW402250	2" x 250' 216/box	-	-	-

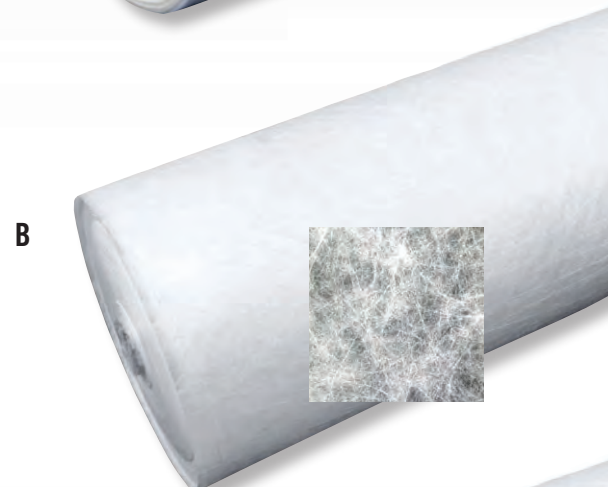

(C) ADO Pro Wall Plus

ADO Pro Wall 50 (Basis Weight 1.5 oz per sq yard) fabric is ideal for knee walls, ceilings, sound walls and many other applications. Keep your job site dust free. ADO Pro Wall 50 passes ASTM E84. Made from 100% polyester which has a low propensity for mold growth versus polypropylene.

KEY	SKU	DESCRIPTION	MIN QTY	ROLLS/BAG	ROLLS/PALLET
C	PW504375	4' x 375'	1 roll	1	18
	PW508750	8' x 750', folded	1 roll	1	12
	PW509750	9' x 750', folded	1 roll	1	12
	PW5010375	10' x 375', folded	1 roll	1	12

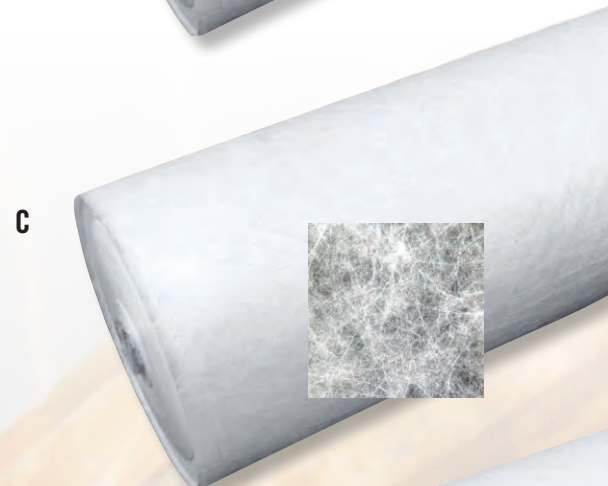

(D) ADO Pro Web

Our premium grade non-woven netting made of 100% polypropylene. The 8', 9' and 10' rolls are folded. Ideal for wet/damp spray installations.

KEY	SKU	DESCRIPTION	MIN QTY	ROLLS/BAG	ROLLS/PALLET
D	IW28750	28" x 750'	1 roll	1	18
	IW32750	32" x 750'	1 roll	1	18
	IW4375	4' x 375'	1 roll	1	30
	IW4500F	4' x 1500'	1 roll	1	12
	IW8200F	8' x 750', folded	1 roll	1	12
	IW9200F	9' x 750', folded	1 roll	1	12
	IW1000F	10' x 375', folded	1 roll	1	12
	IW108125F	108" x 125 yd, folded	1 roll	1	25
	IW108250F	108" x 250 yd, folded	1 roll	1	12
	IW120125F	120" x 125 yd, folded	1 roll	1	25
	IW96125F	96" x 125 yd, folded	1 roll	1	25
	IW96250F	96" x 250 yd, folded	1 roll	1	12

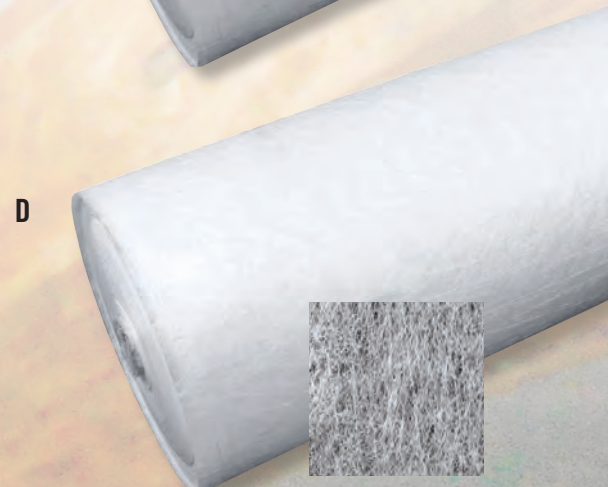

STAPLES

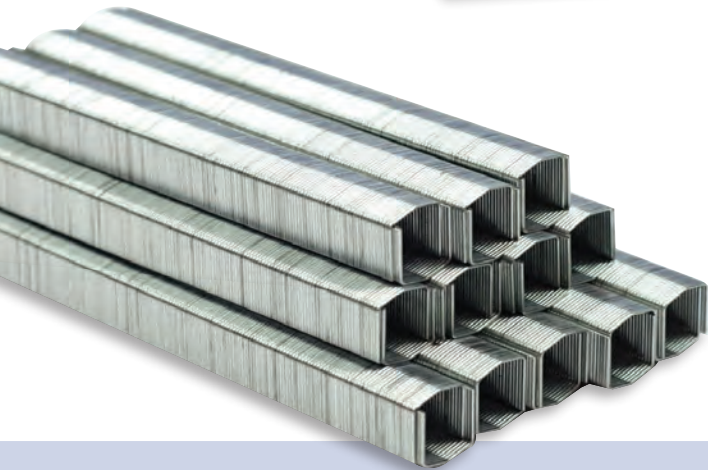

ADO Galvanized Staples

Consistent quality that prevents jamming or breakage (no chicklets). Our staples are engineered to fit B&C Eagle, Fasco, Josef Kihlberg, Bostitch, Duo-Fast, Rapid, Arrow, and Prebena staplers. Each box contains 5,000 staples unless otherwise noted.

SKU	DESCRIPTION	FITS TACKER/STAPLER:	BOXES/CASE	CASES/PALLET
B1950	STCR261906—1/4"	HTH306	50	48
B2000	STCR261908—5/16"	HTH306	50	48
B5000	STCR261910—3/8"	HTH306	50	30
B2250	STCR501906—1/4"	HTH308, HTPC2K	20	48
B2500	STCR501910—3/8"	HTH308, HTPC2K	20	48
D3575	DF5008—1/4"	HT550CL, F1A50, BCED	20	64
D3000	DF5010—5/16"	HT550CL, F1A50, BCED	20	64
J6000	No. 7—1/4", 10M/box	JK670, F1A7C, BCEJ670	20	48
J6225	No. 7—5/16", 10M/box	JK670, F1A7C, BCEJ670	20	48
K7000	No. 8—5/16", 10M/box	JK680, F1A80, BCEK680	20	48
K7250	No. 8—1/2", 6M/box	JK680, F1A80, BCEK680	20	60
R4575	RA19—1/4"	HTA19	50	48
RA1026	RA11—1/4"	HTA11, T-50, F1A11, HTPF9, BCERA, R311	20	64
RA1008	RA11—5/16"	HTA11, T-50, F1A11, HTPF9, BCERA, R311	20	64
RA1010	RA11—3/8"	HTA11, T-50, F1A11, HTPF9, BCERA, R311	20	64
A1650	1/2", 5M/box	T-50, F1A11, BCERA	20	64

(A-B) B&C Eagle and Josef Kihlberg

Lightweight Pneumatic tools designed for applying netting and roofing felt. Up to 1700 staples per minute. Easily adjusts to operator preferences. Double-length magazine provides large load capacity. Note: All B&C Eagle and Josef Kihlberg pneumatic staplers will need a Milton plug, male—1/4".

KEY	SKU	DESCRIPTION	STAPLES USED:	MIN QTY
A	BCEJ670	Stapler, Pneumatic Auto Fire, J Series	J6000, J6225	each
	BCEK680	Stapler, Pneumatic Auto Fire (80 series) K Series	K7000, K7250	each
	BCED	Stapler, Pneumatic Auto Fire, D Series	D3575, D3000, D3000G	each
	BCERA	Stapler, Pneumatic Auto Fire, RA Series	RA1026, RA1008, RA1010, A1650	each
B	JK670	Josef Kihlberg JK670L, auto-fire	J6000, J6225	each
	JK680	Josef Kihlberg JK680L, auto-fire	K7000, K7250	each





(A–B) Stanley Bostitch

The H30-6 and the H30-8 PowerCrown™ staplers feature a compact, powerful design and quick-load magazines. The H30-6 uses thinner 26 gauge wire staples and the H30-8 uses thicker 50 gauge wire staples. The H30-6 can be fitted with 1/4", 5/16" or 3/8" staples; the H30-8 with 1/4" or 3/8" staples; and the PC2K with 1/4" or 3/8" staples.

KEY	SKU	DESCRIPTION	MIN QTY	TACKERS/CASE
A	HTH306	Bostitch H30-6	each	6
	HTH308	Bostitch H30-8	each	6
B	HTPC2K	Bostitch PC2K	each	4

Refer to schematics on page 66.

(C–E) B&C Eagle Rapid

- R311 – simple and reliable bottom-loading for staples between 1/4" to 1/2" with reversible driver blade
- A-11 – Easy to load and operate All-steel construction, and can be fitted with 1/4", 5/16" or 3/8" staples
- A-19 – Smaller, disposable version offering the most economical tacker/staple combination on the market and can be fitted with 1/4" staples

KEY	SKU	DESCRIPTION	MIN QTY	TACKERS/CASE
C	R311	Rapid R311	each	10
D	HTA11	Rapid A-11	each	10
E	HTA19	Rapid A-19	each	10

(F) Duo-Fast

The HT-550 Classic features durable construction and two-strip staple capacity. Can be fitted with 1/4" or 5/16" staples.

KEY	SKU	DESCRIPTION	MIN QTY	TACKERS/CASE
F	HT550CL	Duo-Fast HT-550 Classic	each	5

Refer to schematics on page 66.

K



(K) Pneumatic Tool Accessories

KEY	SKU	DESCRIPTION	MIN/QTY
K	TT8	Tool Tonic oil—8 oz bottle	each

L



(G) B&C Eagle Prebena

A reliable and economical replacement for the Rapid A-11.

KEY	SKU	DESCRIPTION	MIN QTY	TACKERS/CASE
G	HTPF9	Prebena FP-PF9-S19	each	10



(H) B&C Eagle HT 550H

Heavy Duty 5000 Series Hammer Tacker that works with 1/2" crown 5000 series 1/4" to 3/8" staples. The B&C Eagle HT 550H features a quick loading magazine and a comfortable rubber grip. Magazine is designed to fit two sleeves of our D3575 or D3000 staples.

KEY	SKU	DESCRIPTION	MIN QTY	TACKERS/CASE
H	ADOHT550H	B&C Eagle HT 550	each	10



(I) Genuine Bostitch Staples

High quality, light duty PowerCrown™ galvanized staples, w/blunt chisel point.

KEY	SKU	DESCRIPTION	FITS TACKER/STAPLER:	BOXES/CASE	CASES/PALLET
I	B2000G	Bostitch STCR261908	HTH306	20	112
		5/16", 5M/box			

(J) Genuine Duo-Fast Staples - 5000 Series

Wide crown fine wire staples are high quality, chisel-point. Galvanized.

KEY	SKU	DESCRIPTION	FITS TACKER/STAPLER:	BOXES/CASE	CASES/PALLET
J	D3000G	Duo-Fast DF5010	HT550CL	20	36
		5/16", 5M/box			
	5008CDF	Duo-Fast DF5010	HT550CL	20	36
		1/4", 5M/box			

(L) Air Hoses

Contractor's Choice reinforced polyurethane air hose. Lightweight—only 3.69 lbs for a 100' hose. Tough reinforced polyurethane—250 psi. Won't kink, twist or crush—flexible down to -40°F. Sold as pre-made assemblies with reusable fittings. Couplers, connectors, reusable ends for mending sold separately.

SKU	DESCRIPTION	MIN QTY
PUR14X25	Air hose w/reusable ends—1/4" x 25' ††	each
PUR14X50	Air hose w/reusable ends—1/4" x 50' ††	each
PUR14X100	Air hose w/reusable ends—1/4" x 100' ††	each
PUR38X50	Air hose w/reusable ends—3/8" x 50' ††	each
PUR38X100	Air hose w/reusable ends—3/8" x 100' ††	each

†† Note: 1/4" and 3/8" hoses have 1/4" male NPT hose ends.

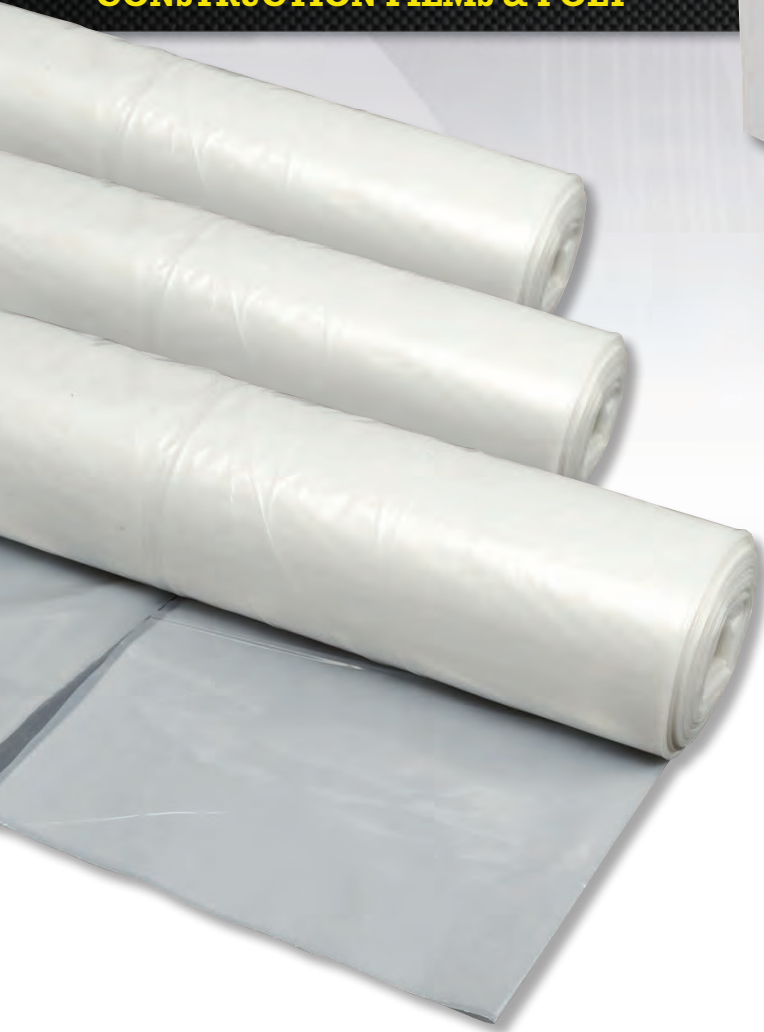

WIDTH	SKU NUMBER	DIMENSIONS	THICKNESS	ADO STOCKED	COLOR
4'	UP4004	4' x 100'	4 mil	-	Clear
4'2"	UP4220	4'2" x 200'	2 mil	Yes	Clear
6'	UP6040	6' x 100'	4 mil	-	Clear
6'	UP6060	6' x 100'	6 mil	-	Clear
8'	UP8030	8' x 100'	3 mil	-	Clear
8'	UP8040	8' x 100'	4 mil	Yes	Clear
8'	UP8060	8' x 100'	6 mil	Yes	Clear
8'	UP8060B	8' x 100'	6 mil	Yes	Black
8'4"	UP8415	8'4" x 200'	1.5 mil	Yes	Clear
8'4"	UP8420	8'4" x 200'	2 mil	Yes	Clear
8'4"	UP8440	8'4" x 200'	4 mil	Yes	Clear
8'4"	UP8440F	8'4" x 200'	4 mil	Yes	Flame
8'4"	UP8460	8'4" x 200'	6 mil	Yes	Clear
9'	UP9007	9' x 400'	.7 mil	Yes	Clear
9'	UP9040	9' x 100'	4 mil	Yes	Clear
9'	UP9040F	9' x 100'	4 mil	-	Flame
9'4"	UP9440	9'4" x 100'	4 mil	Yes	Clear
9'4"	UP9440F	9'4" x 100'	4 mil	Yes	Flame
9'4"	UP9460	9'4" x 100'	6 mil	-	Clear
10'	UP1020	10' x 100'	2 mil	Yes	Clear
10'	UP1030	10' x 100'	3 mil	-	Clear
10'	UP1040	10' x 100'	4 mil	Yes	Clear
10'	UP1060	10' x 100'	6 mil	Yes	Clear
10'	UP1060B	10' x 100'	6 mil	Yes	Black
10'4"	UP10440	10'4" x 100'	4 mil	Yes	Clear
12'	UP1207	12' x 400'	.7 mil	Yes	Clear
12'	UP12003	12' x 400'	.3 mil	Yes	Clear
12'	UP1201	12' x 400'	1 mil	-	Clear
12'	UP1215	12' x 200'	1.5 mil	Yes	Clear
12'	UP1220	12' x 200'	2 mil	Yes	Clear
12'	UP1230B	12' x 100'	3 mil	-	Black
12'	UP1230	12' x 100'	3 mil	Yes	Clear
12'	UP1240	12' x 100'	4 mil	Yes	Clear
12'	UP1240B	12' x 100'	4 mil	Yes	Black
12'	UP1260	12' x 100'	6 mil	Yes	Clear
12'	UP1260B	12' x 100'	6 mil	Yes	Black
12'	UP1260F	12' x 100'	6 mil	-	Flame
12'4"	UP12440	12'4" x 100'	4 mil	Yes	Clear
14'	UP1440	14' x 100'	4 mil	Yes	Clear
16'	UP1615	16' x 100'	1.5 mil	-	Clear
16'	UP1640	16' x 100'	4 mil	Yes	Clear
16'	UP1660	16' x 100'	6 mil	Yes	Clear
20'	UP2012	20' x 100'	1.2 mil	Yes	Clear
20'	UP2015	20' x 100'	1.5 mil	-	Clear
20'	UP2020	20' x 100'	2 mil	-	Clear
20'	UP2030	20' x 100'	3 mil	-	Clear
20'	UP2040	20' x 100'	4 mil	Yes	Clear
20'	UP2060	20' x 100'	6 mil	Yes	Clear
20'	UP2060W	20' x 100'	6 mil	Yes	White
20'	UP2060F	20' x 100'	6 mil	-	Flame
20'	UP2010	20' x 100'	10 mil	Yes	Clear
24'	UP2440	24' x 100'	4 mil	-	Clear
24'	UP2460	24' x 100'	6 mil	-	Clear
28'	UP2860	28' x 100'	6 mil	-	Clear
32'	UP3240	32' x 100'	4 mil	Yes	Clear
32'	UP3260	32' x 100'	6 mil	-	Clear
40'	UP4040	40' x 100'	4 mil	Yes	Clear
40'	UP4060	40' x 100'	6 mil	-	Clear

Construction Film

We've got your next project covered—with some of the best construction film available. ADO offers a complete line of poly films available in many sizes, colors and styles.



Special Order Poly
Call 1-800-666-8191

Tyvek® Coverall Suits

Spun bonded olefin fabric made from high density polyethylene fibers that offer excellent protection and strength.

STYLE	SKU	DESCRIPTION	MIN QTY
A	CVLTVKELG	Tyvek Suit - Large, 25/cs	25
	CVLTVKEXL	Tyvek Suit - XL, 25/cs	25
	CVLTVKE3XL	Tyvek Suit - 3X, 25/cs	25
	CVLTVKE5XL	Tyvek Suit - 5XL, 25/cs	25
B	CVLTVKHELG	Tyvek Hooded Suit - Lg, 25/cs	25
	CVLTVKHEXL	Tyvek Hooded Suit - XL, 25/cs	25
	CVLTVKHE2XL	Tyvek Hooded Suit - 2XL, 25/cs	25
	CVLTVKHE3XL	Tyvek Hooded Suit - 3XL, 25/cs	25
	CVLTVKHE4XL	Tyvek Hooded Suit - 4XL, 25/cs	25

Note: Please consult your Account Manager for information on sizing Tyvek® coverall suits.

Tyvek® Alternative Coverall Suits

Cost savings alternative to Tyvek that provides outstanding protection, durability and comfort.

STYLE	SKU	DESCRIPTION	MIN QTY
A	CVLKGELG	Coverall Suit - Lg non-hooded, 25/cs	25
	CVLKGEXL	Coverall Suit - XL non-hooded, 25/cs	25
	CVLKG2XL	Coverall Suit - 2XL non-hooded, 25/cs	25
	CVLKG3XL	Coverall Suit - 3XL non-hooded, 25/cs	25
	CVLKG4XL	Coverall Suit - 4XL non-hooded, 25/cs	25
	CVLKG5XL	Coverall Suit - 5XL non-hooded, 25/cs	25
B	CVLKGHELG	Coverall Hooded Suit - Lg, 25/cs	25
	CVLKGHEXL	Coverall Hooded Suit - XL, 25/cs	25
	CVLKGHE2XL	Coverall Hooded Suit - 2XL, 25/cs	25
	CVLKGHE3XL	Coverall Hooded Suit - 3XL, 25/cs	25
	CVLKGHE4XL	Coverall Hooded Suit - 4XL, 25/cs	25

MicroMax Suits

MicroMax HBF (High Breathability Fabric) utilizes a conically perforated membrane and a proprietary meltblown layer to provide wearers with unmatched barrier and comfort.

STYLE	SKU	DESCRIPTION	MIN QTY
B	HBF428XL	MicroMax HBF Hooded Suit - XL	25
	HBF4282XL	MicroMax HBF Hooded Suit - 2XL	25
	HBF4283XL	MicroMax HBF Hooded Suit - 3XL	25
	HBF4285XL	MicroMax HBF Hooded Suit - 5XL	25

SMS Suit w/booties

Spun bonded polypropylene fabric.

STYLE	SKU	DESCRIPTION	MIN QTY
C	CVLSMSB2XL	SMS Hooded Suit w/booties - 2XL, 25/cs	25
B	CVLSMSHXL	SMS Hooded Hooded Suit - XL, 25/cs	25

Value Suits

Spun bonded polypropylene fabric is a lightweight, breathable fabric that provides economical protection against non-hazardous, grimy work environment applications. It is the best low cost solution.

STYLE	SKU	DESCRIPTION	MIN QTY
C	CVLNWBLG	Value Hooded Suit w/booties - Lg, 25/cs	25
	CVLNWBXL	Value Hooded Suit w/booties - XL, 25/cs	25
	CVLNWB2XL	Value Hooded Suit w/booties - 2XL, 25/cs	25
	CVLNWB3XL	Value Hooded Suit w/booties - 3XL, 25/cs	25
	CVLNWB4XL	Value Hooded Suit w/booties - 4XL, 25/cs	25



Style A

Style B



Style C

PROTECTIVE WEAR & PAPR SUPPLIED AIR SYSTEMS



(A) Protective Shoe Covers

KEY	SKU	DESCRIPTION	MIN QTY
A	SCTVKSRL	Tyvek® NS Shoe Cover - Large, 200/cs	200
	SCKGXL	Tyvek® Alternative Shoe Cover - XL, 300/cs	300
	SCSSLG	Value NS Shoe Cover (white) - Lg, 300/cs	300
	SCSSXL	Value NS Shoe Cover (Blue) - XL, 300/cs	300

(B) Protective Boot Covers

KEY	SKU	DESCRIPTION	MIN QTY
B	BCTVKSRL	Tyvek® NS Boot Cover - L, 200/cs	200
	BCKGL	Tyvek Alternative Boot Cover - L, 200/cs	200

(C) Protective Sleeves

Perfect for hot and uncomfortable applications. These protective sleeves cover the arms from the end of a short sleeve shirt to the wrist. Just enough protection to keep debris off of the arms without enclosing the installer in a complete suit.

KEY	SKU	DESCRIPTION	MIN QTY
C	AGTVKIL	Tyvek® 18" Sleeve (Large) - 200/cs	200
	AGKGL	Tyvek Alternative 18" Sleeve (Large) - 200/cs	200

(D) 3M Hood Assembly, Collar, Premium Head Suspension for PAPR System

The 3M Hood Assembly S-655 consists of a S-950 Premium Head Suspension and a S-605 Hood. Approved for use with certain 3M Powered Air Purifying and Supplied Air Respirator Systems.

KEY	SKU	DESCRIPTION	MIN QTY
D	3MS655	3M Hood Assembly, Collar, Premium Head Suspension	each
	3MS922	3M Lense Cover Peel-Offs (3M S-655 Hood)	40/pk

(E) 3M Breathing Tube for PAPR System

This breathing tube is used on 3M GVP Systems with S Series Hoods.

KEY	SKU	DESCRIPTION	MIN QTY
E	3MBT20L	3M Breathing Tube	each

(F) 3M Belt-Mounted PAPR Assembly for PAPR System

Includes the components needed to make a complete 3M PAPR System. Assembly includes: PAPR Unit GVP-100, Power Cord GVP-110, Battery Pack GVP-111, Battery Charger GVP-112, Flow Meter GVP-113, Blower Plugs GVP-115 and Waist Belt GVP-127.

KEY	SKU	DESCRIPTION	MIN QTY
F	3MGVP1	3M Belt-Mounted PAPR Assembly	each

(G) 3M Replacement Power Cord for 3MGVP1 PAPR System

Provides the necessary connection between the battery and the motor blower on the 3MGVP1.

KEY	SKU	DESCRIPTION	MIN QTY
G	3MGVP110	3M Replacement Power Cord-3MGVP1 PAPR Assembly	each

(H) 3M Battery Charger only for PAPR System

KEY	SKU	DESCRIPTION	MIN QTY
H	3MGVP112	3M PAPR Battery Charger only	each

(I) 3M Organic Vapor/High Efficiency Cartridge for PAPR System

This Organic Vapor/High Efficiency Cartridge is used with the 3M Belt-Mounted Powered Air Purifying Respirator (PAPR) System. It attaches to the motor blower and filters the air supplied to the headgear.

KEY	SKU	DESCRIPTION	MIN QTY
I	3MGVP441	3M Organic Vapor/High Efficiency Cartridge	each

(A) Allegro Full Mask Continuous Flow Supplied Air Respirator for SAR System

Made of silicone rubber for durability and will hold its shape even in extreme heat and cold. Double sealing flange provides an improved face-to-mask seal and a deep chin pocket provides a better, more comfortable fit. Replaceable polycarbonate lens offers a wider, distortion-free viewing area with an anti-fog, anti-scratch coating. Unique “over the shoulder” hose design clips at the collar. Comes with OBAC quick connects. NIOSH approved.

KEY	SKU	DESCRIPTION	MIN QTY
A	9901	Full Face Respirator - Low Pressure	each
	9902	Full Face Respirator - High Pressure	each
	990125	Lens Cover Peel Offs (for 9901), full face mask	25/pk
	2025	Full Face Respirator Storage Bag	each
	990109L	Replacement Lens for 9901 Full Face Respirator	each

(B) Low Flow Adapter for SAR System

For use as a low pressure supplied air respirator, the Low Pressure Flow Adapter allows the hood to connect to an ambient air pump, or any low pressure air source. Low profile, lightweight, plastic threaded fitting offers the convenience of OBAC quick connect design with a belt and clip assembly. Requires an air supply pressure range of 2 to 40 psi.

KEY	SKU	DESCRIPTION	MIN QTY
B	991011	Low Flow Adapter for SAR System	each

(C) Tyvek® Hood Assembly with Suspension for SAR System

Designed with one piece construction breathing tube and head suspension integrated with hood assembly. Fully disposable, eliminating need for decontamination. Flexible and splash resistant multi-layer sound dampening breathing tube ideal for workers with beards or goggles. Designed to connect to Adjustable Flow Control Valve, Personal Air Cooler or Air Temperature Controller.

KEY	SKU	DESCRIPTION	MIN QTY
C	991120	Tyvek Hood w/suspension for SAR System - replacement	each
	991003	Ratchet Hood Suspension for the 991120 Tyvek Hood	each
	991025	Lens Cover Peel-Offs (991120 Hood)	10/pk

(D) Allegro Ambient Air Pump for SAR System

The easiest way to meet your needs for portable air sources for up to three respirator users or two hood users.

KEY	SKU	DESCRIPTION	MIN QTY
D	9832	Ambient Air Pump, 1500 (0-20cfm) w/OBAC Fittings	each

(E) Allegro Ambient Air Pump - Model A-75

Portable & Lightweight air source for one-hood user, or up to two full or half face respirator users. Solid performance in a multiple of applications.

KEY	SKU	DESCRIPTION	MIN QTY
E	9821	Ambient Air Pump, Model A-75 3/4 hp motor	each

(F) Respirator Air Hose for SAR System

KEY	SKU	DESCRIPTION	MIN QTY
F	9100100	Respirator air hose extension -100' Low Pressure	each
	9100100B	Respirator air hose extension -100' High Pressure	each
	910050	50' breathing airhose - 3/8" diameter	each

(G-H) Spray Sock

One-size-fits-all painters spray sock fits snugly around head and neck to protect against dirt, dust, and overspray. Available in cotton and lycra.

KEY	SKU	DESCRIPTION	MIN QTY
G	6810LN	Painters Spray Sock, Cotton Blend, 12/pack	pack
H	6910	Painters Spray Sock Deluxe, Lycra, Black	each

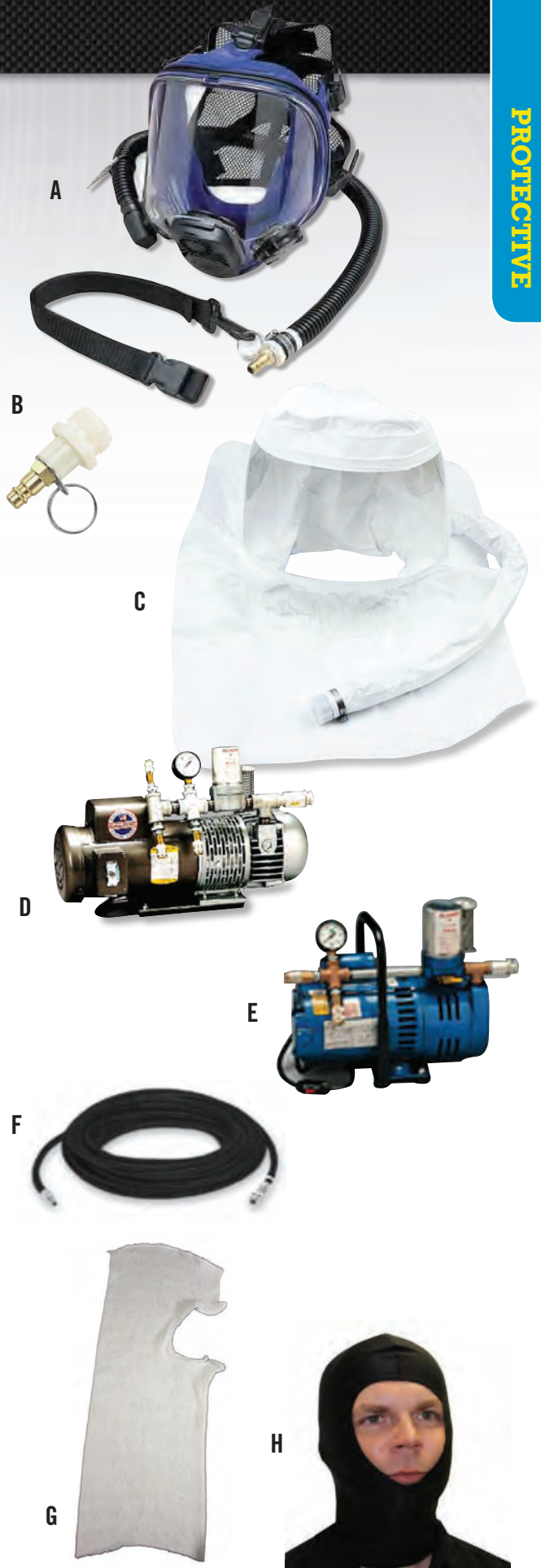

MOLDEX RESPIRATORS



Moldex® Disposable and Reusable Respirators

Breathe easy with a Moldex disposable particulate respirator. They're NIOSH certified to have a filter efficiency of 95% or greater against particulates free of oil. That's some clean air. Enjoy a contoured nose bridge and a soft foam nose cushion for comfortable seal—without a metal nose band. The exclusive Dura-Mesh® shell protects the filter media so it stays clean longer. It's built to resist collapsing in hot and humid conditions so the respirator holds its shape longer. Bottom line—fewer respirators are used = you save money.

(A) Moldex 2600 N95 Respirator, HandyStrap®

- HandyStrap® with buckle allows mask to hang down around neck when not in use
- Stretch cloth strap feels cool and comfortable against the skin
- Softspun® lining for added comfort and durability

KEY	SKU	DESCRIPTION	QTY/BOX	BOXES/CASE	MIN QTY
A	MM2600	Moldex N95 respirator w/HandyStrap	15	12	1 case

(B) Moldex 2300 N95 Respirators with Exhale Valve, 2-Strap

- Exhale valve reduces hot air build-up and keeps workers cooler
- Naturally contoured facepiece with foam nose cushion relieves pressure points
- Softspun® lining gives added comfort and durability

KEY	SKU	DESCRIPTION	QTY/BOX	BOXES/CASE	MIN QTY
B	MM2300	Moldex N95 respirator w/valve, 2 straps	10	10	1 case

(C) Moldex 2200 N95 Respirator, 2-Strap

- Naturally contoured facepiece relieves pressure points
- Softspun® lining gives added comfort and durability

KEY	SKU	DESCRIPTION	QTY/BOX	BOXES/CASE	MIN QTY
C	MM2200	Moldex N95 respirator, 2 straps	20	12	1 case

(D) 1200 N95 Respirator, Dirt Dawg

- Dura-Mesh shell resists collapsing in heat & humidity
- Molded nose bridge seals easily without metal noseband
- Softspun® lining gives added comfort and durability

KEY	SKU	DESCRIPTION	QTY/BOX	BOXES/CASE	MIN QTY
D	MMN95DD	Moldex 1200 N95 Respirator, Dirt Dawg	20	18	1 case

(E) Moldex N100 HandyStrap®

- HandyStrap® with buckle allows mask to hang down around neck when not in use
- Adjustable cloth feels cool & comfortable
- Ventex valve lets hot air out faster so workers breathe easier and stay cool longer
- Dura-Mesh shell resists collapsing in heat & humidity

KEY	SKU	DESCRIPTION	QTY/BOX	BOXES/CASE	MIN QTY
E	MMN100	Moldex N100 HandyStrap	20	18	1 case

(F-K) Moldex Half- & Full- Face Replacement Parts (7000 & 9000 Series)

KEY	SKU	DESCRIPTION	MIN QTY
F	MM7020	Moldex Pre-Filter Retainer 1 pair/bag	1 pair
G	MM7920	Moldex Filter Disk Piggyback Adapter, 7000/9000 series	each
H	MM7990	Moldex 7000/9000 Series P100 Cartridge	each
I	MM7100	Moldex 7100 Respirators organic vapor pvc free	each
J	MM7140	Moldex 7000/9000 Series Stacked Cartridge/Filter	each
K	MM7940	Moldex P100 Particulate Filter Disk, 1 pair per bag	1 pair



D



E



F

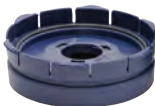

G



H



I



J



K



(A) Moldex Half-Face Protection 7000 Series

PVC-Free®. Sleek and light-weight design for modern, high-tech look and increased worker acceptance. Extra-wide sealing area provides all-day comfort. Fits well under welding helmets and with safety glasses. Mask drops down for convenient storage around the neck or locks down for custom fit.

KEY	SKU	DESCRIPTION	MIN QTY
A	MM7001	Moldex Half-Face, 7000 series—Small	each
	MM7002	Moldex Half-Face, 7000 series—Medium	each
	MM7003	Moldex Half-Face, 7000 series—Large	each



(B-C) Moldex Full-Face Protection 9000 Series

Cost effective, high-tech, streamlined design for exceptional worker acceptance. Exclusive over-molded lens offers greater field of vision. Lighter weight for superior all-day comfort. Fewer parts means less cost and easy maintenance. Tear away lens protector included. Meets ANSI Z87+ for high impact requirements

KEY	SKU	DESCRIPTION	MIN QTY
B	MM9002	Moldex Full-Face, 9000 series—Medium	each
	MM9003	Moldex Full-Face, 9000 series—Large	each
C	MM0093	Lenze Cover Peel-Offs (9000 Series)	15/pk



EYE PROTECTION

(D-E) Goggles & Lens Covers

A030 - Advanz Goggles contain 30 frame advances. Disposable with anti-fog lens, fits over eye glasses.

C045 - Advanz Lens Cover fits over all brands of full-face respirators and contains 36 frame advances.

KEY	SKU	DESCRIPTION	MIN QTY	QTY/CASE
D	A030	Goggles, Disposable Anti-Fog	each	24
E	C045	Goggles, Lens Cover, Clear	each	24

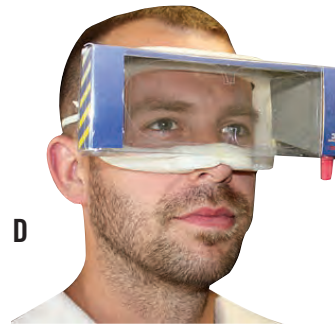

(F-G) Goggles & Lens Covers

5110 - Anti-fog coating on interior lens, 99.9% UV protection, vents prevent liquid from getting into eyes, curved lens and anti-splash design. Meets ANSI Z87.1.

5111 - Package of 10. Protect the lens on your goggles with these easy-to-use peel-off lens covers. Covers protect lens against paint and chemical overspray.

KEY	SKU	DESCRIPTION	MIN QTY	QTY/CASE
F	5110	Goggles, Overspray	each	1 each
G	5111	Goggles, Peel-off Lens Covers	1 pack	10/pk



(H-I) Goggles & Lens Covers

5106 - Anti-splash, special vents prevent liquid from getting into eyes, impact resistant polycarbonate lens sportstyle design flexible PVC construction, anti-fog coating on lens, wide elastic headstrap, 99.9% UV protection. Peel-off lens covers (510610) available. Meets current ANSI Z87.1 2003 Standard.

510610 - Keep overspray off your lens, use peel-off lens covers on your goggles. Comes in a package of 10 peel-offs.

KEY	SKU	DESCRIPTION	MIN QTY	QTY/CASE
H	5106	Goggles, Deluxe Overspray	each	1 each
I	510610	Goggles, Deluxe Peel-off Lens Covers	1 pack	10/pk



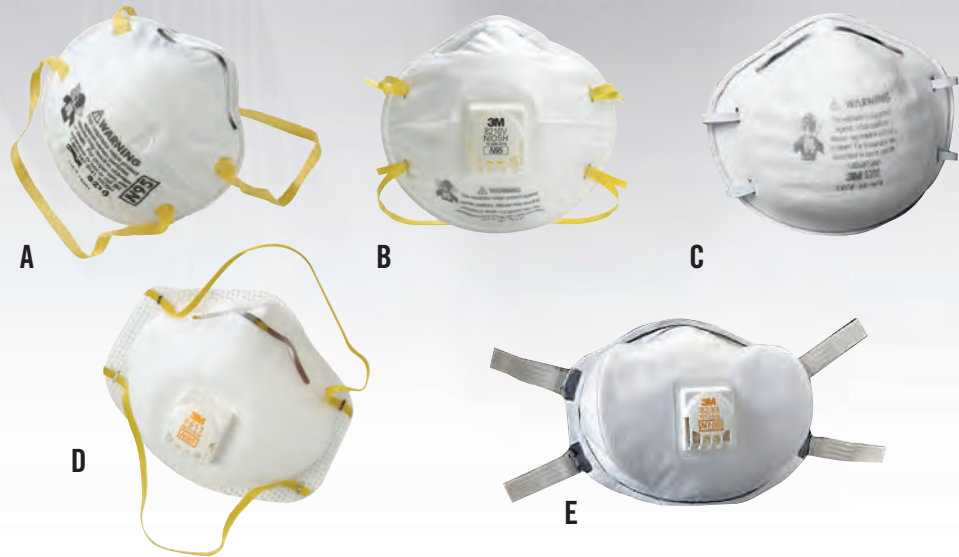

3M Masks and Respirators

Using a variety of patented technologies and features that enable them to filter a broad range of particles, these 3M disposable masks are NIOSH certified to have a filter efficiency of 95% or greater against particulates free of oil. The patented filter media uses advanced electrostatically charged micro fibers to help make breathing easier and cooler for advanced comfort. 3M masks are lightweight for more comfort and increased wear time on the job.



F

G

(A-B) 3M 8210 N95 Respirator, 2-Strap

KEY	SKU	DESCRIPTION	QTY/BOX	BOXES/CASE	CASES/PALLET	MIN QTY
A	3M8210	3M N95 Respirator, 2 straps	20	8	40	1 case
B	3M8210V	3M N95 Respirator w/valve 2 straps	10	8	40	1 case

(C) 3M 8200 N95 Light Duty Respirator, 2-Strap

KEY	SKU	DESCRIPTION	QTY/BOX	BOXES/CASE	CASES/PALLET	MIN QTY
C	3M8200	3M L.D. N95 Respirator	20	8	40	1 case

(D) 3M 8511 N95 Respirator with Exhalation Valve, 2-Strap

KEY	SKU	DESCRIPTION	QTY/BOX	BOXES/CASE	CASES/PALLET	MIN QTY
D	3M8511	3M N95 Respirator w/valve, 2 straps	10	8	35	1 case

(E) 3M 8233 N100 Respirator

KEY	SKU	DESCRIPTION	BOXES/CASE	CASES/PALLET	MIN QTY
E	3M8233	3M N100 Respirator	20	32	1 case

(F-G) 3M Filter Disks

NIOSH approved filter disks provide at least 95% filtration efficiency against solid and liquid aerosols including oils. NIOSH 42 CFR 84.

KEY	SKU	DESCRIPTION	MIN QTY
F	3M2071	3M P95 Filter disk	1 pair
G	3M2091	3M P100 Filter disk	1 pair

(H-K) 3M Half- & Full- Face Replacement Parts

KEY	SKU	DESCRIPTION	MIN QTY
H	3M501	3M 501 Half Face Respirator Filter Retainer	each
I	3M5P71	3M 5P71 Half Face Respirator Particulate Filter	each
J	3M6001	3M 6001 Half Face Respirator Organic Vapor Cartridge	1 pair
K	3M60921	3M Cartridge/Filter, Organic Vapor/P100	1 pair



H



I



J



K



(A) 3M Half-Face Respirators, 6000 Series

The 6000 series half-face respirator provides reusable, economical protection. Facepiece is made from soft, lightweight thermoplastic elastomer which offers unsurpassed comfort and maximum versatility with an easy to adjust standard head strap. Compatible P95 rated particle filters are simple to remove and replace, with a built in set and twist feature, which eliminates the need for a filter holder.

KEY	SKU	DESCRIPTION	MIN QTY
A	3M6100	3M Half-faced Respirator—Small	each
	3M6200	3M Half-faced Respirator—Medium	each
	3M6300	3M Half-faced Respirator—Large	each

Refer to schematics on page 68.

(B) 3M Full-Face Respirators, 6000 Series

KEY	SKU	DESCRIPTION	MIN QTY
B	3M6800	3M Full-Mask Facepiece, Medium	each
	3M6900	3M Full-Mask Facepiece, Large	each

Refer to schematics on page 68.

(C) 3M Lens Assembly, 6000 series Full Facepiece

Use as a replacement part on 3M Full Facepieces 6000 Series

KEY	SKU	DESCRIPTION	MIN QTY
C	3M6898	3M Lens Assembly, 6000 series Full Facepiece	each

(D-M) 3M Half- & Full- Face Replacement Parts

KEY	SKU	DESCRIPTION	MIN QTY
D	3M6885	3M Lens Cover Peel-Offs (6000 Series)	100/pk
E	3M6884	3M Center Port Adapter Full Facepiece	each
F	3M6880	3M Side Caps Full Facepiece	each
G	3M7890	3M Plugs Full Facepiece	each
H	3M6897	3M Head Harness, 6000 series Full Facepiece	each
I	3M6864	3M Center Adapter Assembly, 6000 series	each
J	3M6894	3M Nose Cup Assembly, 6000 series	each
K	3M6893	3M Inhalation Valve, 6000 series	each
L	3M6895	3M Inhalation Gasket, 6000 series	each
M	3M6896	3M Center Adaptor Gasket, 6000 series Full Facepiece	each



D



E



F



G



H



I



J



K



L



M

EYEWEAR ACCESSORIES, HARD HATS & GLOVES



(A) Safety Glasses

High impact polycarbonate lenses, anti-fog coating, 99.9% UV protection, wrap-around design, non-slip temples, scratch resistant lenses, non-slip rubber nose piece. Meets current ANSI Z87.1 2003 standard. Yellow, clear or smoke mirror lens.

KEY	SKU	DESCRIPTION	MIN QTY
A	5400205	Safety Glasses, Diamondback - yellow	each
	5400200	Safety Glasses, Diamondback - clear	each
	5400203	Safety Glasses, Diamondback - smoke mirror	each



(B-D) Single Lens Design Safety Glasses

High impact polycarbonate lenses, 99.9% UV protection, Single Lens Design, scratch-resistant lightweight wrap-around lens. Meets Current ANSI Z87.1+ standard

KEY	SKU	DESCRIPTION	MIN QTY
B	5330	SAS Safety Glasses, NSX Turbo - clear lens	each
C	5331	SAS Safety Glasses, NSX Turbo - smoke lens	each
D	5332	SAS Safety Glasses, NSX Turbo - yellow lens	each

(E) Eye Wear Cleaning Wipes for Masks and Glasses

Perfect for cleaning eyewear or computer screens, these 100 individually wrapped pre-moistened wipes feature anti-fog, anti-static, silicone-free cleaning. Excellent on glass or polycarbonate lenses, the large 5" x 8" wipes are stored in a wall-mounted cardboard dispenser. Dimensions: 4 3/4" w x 9" h x 2 5/8" d

KEY	SKU	DESCRIPTION	MIN QTY	QTY/BOX
E	0350	Eyewear cleaning wipes	box	100



(F) Hard Hats

Nylon suspension with adjustable head cradle. Complies with ANSI Z89.1, Class G, E and C.

KEY	SKU	DESCRIPTION	MIN QTY	QTY/CASE
F	716001	Hard Hat, White	each	12
	716045	Hard Hat, w/Ratchet, White	each	12

(G) SAS N95 Respirator, 2-Strap

KEY	SKU	DESCRIPTION	QTY/BOX	BOXES/CASE	MIN QTY
G	8610	N95 Respirator, 2 strap	20	8	1 case

(H) Duck Billed, Foldable, N95 Dust Mask

KEY	SKU	DESCRIPTION	QTY/CASE
H	DBN95MASK	Foldable N95 Dust Mask with Head Strap	400/case



(I) Eye Wash

KEY	SKU	DESCRIPTION	MIN QTY
I	7006PK	Eye wash—4 oz bottles	each



(J) First Aid Kit

25 person, 113 piece kit designed for contractors. The steel case contains 17 key first aid products including bandages, gauze pads, compresses, eye care products, ointment, wipes, tape, scissors and tweezers. This kit meets OSHA and ANSI requirements.

KEY	SKU	DESCRIPTION	MIN QTY
J	FA223	First aid kit—25 person	each



(A) G-Tek Gloves

These easy-grip gloves are perfect for the insulation industry. Constructed of woven nylon, the nitrile coated palm and fingers will allow you to pick up the smallest of items without having to remove your gloves.

KEY	SKU	DESCRIPTION	MIN QTY
A	G225M	Nylon gloves, nitrile dipped—Medium	1 pair
	G225L	Nylon gloves, nitrile dipped—Large	1 pair
	G225XL	Nylon gloves, nitrile dipped—X-Large	1 pair



(B) Double-Dot FingerNails™ Gloves

Seamless cotton/polyester gloves with two-sided PVC dots.

KEY	SKU	DESCRIPTION	MIN QTY
B	G2DDL	Gloves, FingerNails™ double dot—Large	1 pair



(C) Leather Palm Work Gloves

Leather palm work glove constructed of heavy side split cowhide.

KEY	SKU	DESCRIPTION	MIN QTY
C	6706529	Gloves, Split Palm Leather	1 pair

(D) Latex Palm Coat Gloves

String knit glove with a blue latex palm. Coated palm offers abrasion resistance and increased grip. Uncoated back allows the hand to breathe.

KEY	SKU	DESCRIPTION	MIN QTY
D	G122L	Gloves, String Knit, Blue Latex Palm Coat, Large	1 pair

(E) Brown Jersey Gloves

Strong, comfortable hand protection, 8 oz. brown cotton jersey knit. Ideal for general purpose applications.

KEY	SKU	DESCRIPTION	MIN QTY
E	6706563	Gloves, Brown Jersey, Mens	1 pair



(F) Pro Impact Black “High Performance” Gloves

Synthetic leather palm for secure grip, silicone strips on fingertips for handling small tools and parts, padded palms. Perfect for use with pneumatic tools. Velcro® closure.

KEY	SKU	DESCRIPTION	MIN QTY
F	6713	Gloves, Pro Impact Black—Large	1 pair
	6714	Gloves, Pro Impact Black—X-Large	1 pair



(G) Vinyl-Guard Gloves

Economical and comfortable USDA accepted, latex-free, consistent quality, sensitive touch beaded cuff, 4 Mil.

KEY	SKU	DESCRIPTION	MIN QTY
G	6508	Gloves, Vinyl-Guard lightly powdered, L	100/box

(H) Nitrile Gloves

Nitrile gloves - superior puncture and abrasion resistance. Latex-free, consistent quality, textured grip with a beaded cuff. Ambidextrous gloves. 5 Mil.

KEY	SKU	DESCRIPTION	MIN QTY
H	6608	Gloves, Nitrile-lightly powdered, L	100/box
	6609XL	Gloves, Nitrile-lightly powdered, XL	100/box

(I) Nitrile Gloves

Powder Free exam grade gloves. 8 mil with a 12" length for added protection. Latex free with a textured grip. 50 gloves/box.

KEY	SKU	DESCRIPTION	MIN QTY
I	660940XL	Gloves, Nitrile-Powder Free, 8 mil, 12" length, XL	50/box



BLOWING HOSES



(A) Mark II Hose

The industry standard. Lightweight polyethylene hose features abrasion-resistant crown and translucent ribbed walls for easy monitoring of material flow. Durable and economical. Interior walls are designed to fluff material.

KEY	SKU	DESCRIPTION	MIN QTY
A	MK1550	Mark II clear hose—1-1/2" x 50'	each
	MK2050	Mark II clear hose—2" x 50'	each
	MK2510	Mark II clear hose—2-1/2" x 10'	each
	MK2550	Mark II clear hose—2-1/2" x 50'	each
	MK3050	Mark II clear hose—3" x 50'	each
	MK3550	Mark II clear hose—3-1/2" x 50'	each
	MK4050	Mark II clear hose—4" x 50'	each

(B) Mark E-2 Hose

A perfect light weight hose that combines the wire reinforced strength of the Urethane Flexible style hoses, constructed out of Polyethylene material like the industry standard Mark II style hoses. The clear E-2 style hose with a spring steel wire helix provides efficient flow characteristics and is abrasion resistant. The maximum negative pressure rating for vacuuming applications far exceeds the ratings of the Mark II style hose and is equivalent to that of the Urethane Flexible style hoses.

KEY	SKU	DESCRIPTION	MIN QTY
B	MK6025W	Clear E-2 Flex hose—6" x 25'	each

(C) Urethane Flex Hose

Very light weight clear polyurethane hose reinforced with a spring steel wire helix that provides excellent flexibility. The smooth bore offers a combination of efficient flow characteristics and abrasion resistance. Moisture resistant, temperature range -65° F to 200° F.

KEY	SKU	DESCRIPTION	MIN QTY
C	FT2050	Clear Urethane Flex hose—2" x 50'	each
	FT2550	Clear Urethane Flex hose—2-1/2" x 50'	each
	FT3050	Clear Urethane Flex hose—3" x 50'	each
	FT3550	Clear Urethane Flex hose—3-1/2" x 50'	each
	FT4050	Clear Urethane Flex hose—4" x 50'	each
	FT6025	Clear Urethane Flex hose—6" x 25'	each

(A-C) Hose Reels

All hose reels have heavy duty bearings. The small and large hose reels stand upright and the extra large hose reel is to be wall mounted.

- X-Large reel holds: 150' of 4" hose, or 200' of 3-1/2" hose
- Large reel holds: 150' of 3" hose, 200' of 2-1/2" hose, or 250' of 2" hose
- Small reel holds: 200' of 3/8" pressure hose

KEY	SKU	DESCRIPTION	MIN QTY
A	HR250	Small, 18" L x 9-3/4" W x 19" H	each
B	HR300	Large, 36" L x 23" W x 39" H	each
C	HR350	X-Large, 44" Dia x 28" W	each

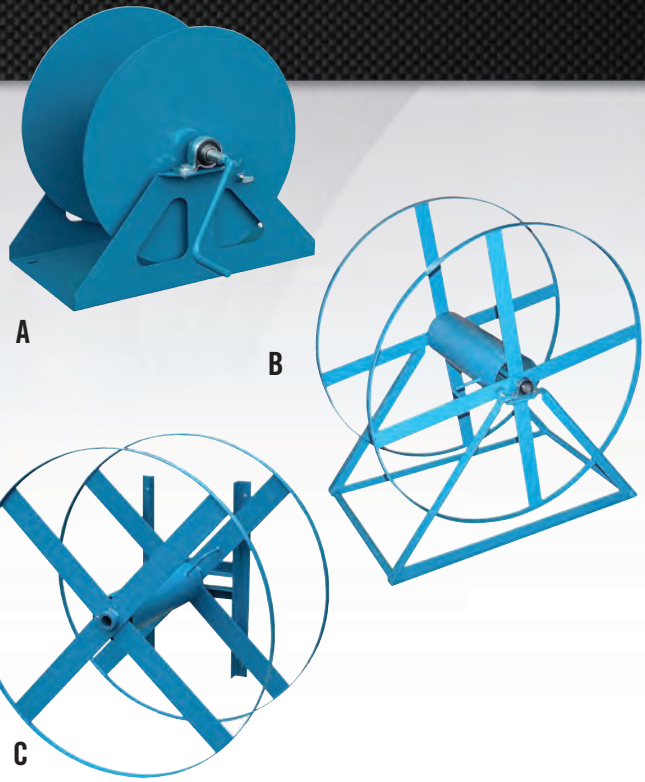

(D) Steel Connectors

Provide durable, secure links between hose sections. Inside extensions are long enough to safely attach clamps for secure fits.

KEY	SKU	DESCRIPTION	MIN QTY
D	SC200	Steel connector—2"	each
	SC250	Steel connector—2-1/2"	each
	SC300	Steel connector—3"	each
	SC349	Steel connector—3-1/2"	each
	SC400	Steel connector—4"	each
	SC600	Steel connector—6"	each

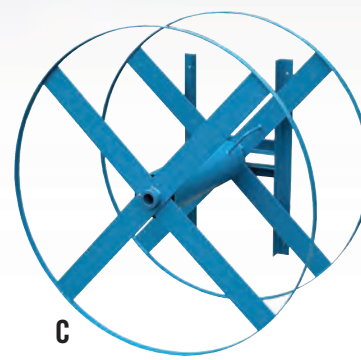

(E) Steel Reducers

KEY	SKU	DESCRIPTION	MIN QTY
E	RC252	Steel reducer—2-1/2" to 2"	each
	RC320	Steel reducer—3" to 2"	each
	RC325	Steel reducer—3" to 2-1/2"	each
	RC352	Steel reducer—3-1/2" to 2-1/2"	each
	RC353	Steel reducer—3-1/2" to 3"	each
	RC430	Steel reducer—4" to 3"	each
	RC435	Steel reducer—4" to 3-1/2"	each
	RC640	Steel reducer—6" to 4"	each



(F) Hose Clamps

Steel clamps with worm drive adjust to fit 2", 2-1/2", 3", 3-1/2", 4" or 6" connectors, reducers or nozzles.

KEY	SKU	DESCRIPTION	MIN QTY
F	CL100	Hose clamp—2" to 3"	each
	CL400	Hose clamp—4"	each
	CL600	Hose clamp—6"	each



(G) Intec Swivel Connectors

Swivel hose connectors can be used for blowing or vacuum applications. They provide the installer freedom and agility to move around by reducing tangles and kinks in the hose.

KEY	SKU	DESCRIPTION	MIN QTY
G	J52053	3" Straight Swivel Hose Connector	each
	J52058	4" Straight Swivel Hose Connector	each
	J52054	6" Straight Swivel Hose Connector	each

DRY-SPRAY NOZZLES

(H-L) Dry-Spray Nozzles

We offer a wide variety of sizes and types of steel nozzles.

KEY	SKU	DESCRIPTION	MIN QTY
H	RN210	Steel reducing nozzle—2" to 1"	each
	RN214	Steel reducing nozzle—2" to 1-1/4" (not shown)	each
	RN215	Steel reducing nozzle—2" to 1-1/2" (not shown)	each
I	BR211	Plastic reducing nozzle—2" - 1" or 1-1/2"	each
J	BN2625	Brick reducing nozzle—1" to 5/8"	each
K	DS201	Directional swivel nozzle—2"	each
	DS251	Directional swivel nozzle—2-1/2"	each
	DS252	Directional swivel reducer—2-1/2" to 2"	each
L	DS200	Directional nozzle—2"	each
	DS250	Directional nozzle—2-1/2"	each

BLOWING MACHINES

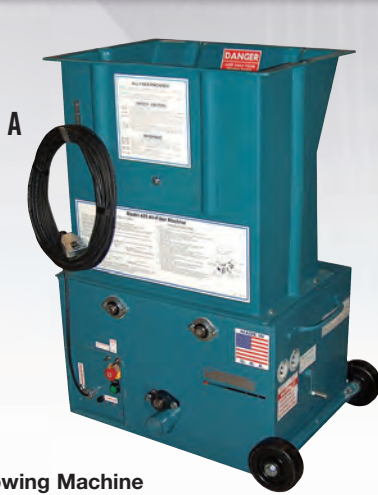

(A) Krendl 425 Blowing Machine

The Krendl 425 is designed for low maintenance, rugged performance, and portability. Provides large hopper capacity with user friendly controls.

Specifications:

- Light weight machine: 220 lbs
- User friendly electric panel
- Hopper capacity: 7 Cubic ft.
- Power requirements:
Single input: 15 AMP, 120 volt/60hz
Double input: 15/15 AMP, 120 volt/60hz
- Output:
Fiberglass: 200 lbs/hour (8 AMP Blower),
480 lbs/hour (14 AMP Blower)
Cellulose: 1100 lbs/hour (8 AMP Blower)
1400 lbs/hour (14 AMP Blower)

KEY	SKU	DESCRIPTION	WEIGHT (LBS)
A	KM425	Blowing Machine, Krendl 425, Single Input, 8 AMP Blower	220
A	KM425D	Blowing Machine, Krendl 425, Double Input, 14 AMP Blower	220

(B) Krendl 475 Blowing Machine

The Krendl 475 is an economical machine for the professional contractor. Designed for low maintenance and high production, the 475 provides a large easy loading hopper while offering simple rugged performance.

Specifications:

- User friendly electronic dashboard
- Double 14 Amp / 2 stage blowers
- Clear acrylic safety guard for easy inspection
- LED start and stop buttons
- Dual variable blower controls
- Digital voltmeter
- Semi pneumatic run flat treaded tire
- Hopper capacity: 14 Cubic ft.
- Power requirements:
Double input: 15/15 AMPs each, 120 volt/60hz
- Output:
Fiberglass: 700 lbs/hour
Cellulose: 2100 lbs/hour

KEY	SKU	DESCRIPTION	WEIGHT (LBS)
B	KM475	Blowing Machine, Krendl 475, Double input	355



B



C

(C) Krendl 575 Blowing Machine

The Krendl 575 provides the highest production in its class for all brands of cellulose and fiberglass. Designed with the professional contractor in mind, the 575 will out perform and outlast the competition.

Specifications:

- Lightest machine in its class
- User friendly electronic dashboard
- Double 14 Amp / 2 stage blowers
- Clear acrylic safety guard for easy inspection
- LED start and stop buttons
- Dual variable blower controls
- Digital voltmeter
- Semi pneumatic run flat treaded tires
- Hopper capacity: 14 Cubic ft.
- Power requirements:
Double input: 30/15 AMPs each, 120 volt/60hz
Single input: 30 AMP, 240 volt/60hz
- Output:
Fiberglass: 800-1000 lbs/hour
Cellulose: 2600-2800 lbs/hour

KEY	SKU	DESCRIPTION	WEIGHT (LBS)
C	KM575D	Blowing Machine, Krendl 575, Double input	380
C	KM575S	Blowing Machine, Krendl 575, Single input	380



A

(A) Krendl 2300 Blowing Machine

Specifically designed for contractors to provide a smaller footprint while capable of blowing all brands of cellulose and fiberglass.

Specifications:

- User friendly electronic dashboard
- 2 HP direct drive motor/reducer
- Hopper capacity: 40 Cubic ft.
- Power requirements:
Double input: 30/20 AMPs each, 120 volt/60hz
Single input: 30 AMP, 240 vold/60hz
- Output:
Fiberglass:1000 lbs/hour
Cellulose: 3000 lbs/hour
- Double blower sytem
- Slide Out Airlock system
- Clear acrylic safety guard allows for easy inspection
- Built in tool holder

KEY	SKU	DESCRIPTION	WEIGHT (LBS)
A	KM2300D	Blowing Machine, Krendl 2300, Double input	846
A	KM2300S	Blowing Machine, Krendl 2300, Single input	846

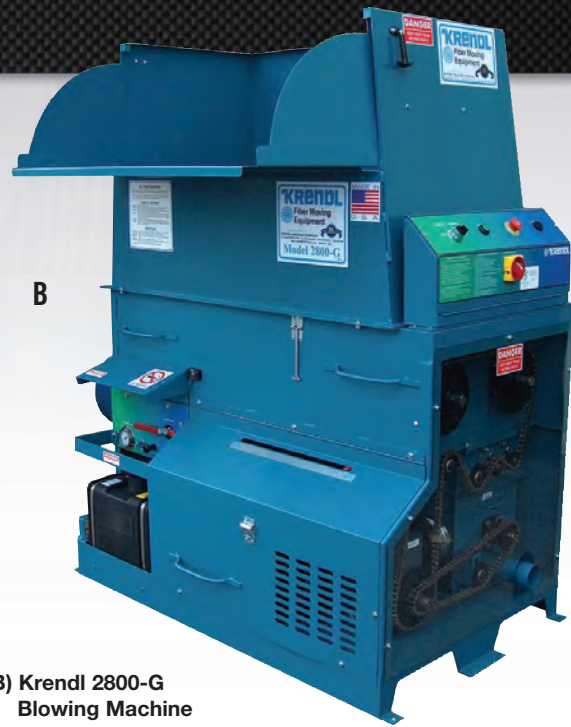

B

(B) Krendl 2800-G Blowing Machine

Specifically designed for contractors to provide a smaller footprint while capable of blowing all brands of cellulose and fiberglass.

Specifications:

- Removable all steel airlock allows quick access for maintenance
- 18 HP Briggs & Stratton V-Twin gas engine w/positive pressure lubrication system
- User friendly 12V DC electric dashboard
- Control panel with engine controls, pressure gauge, and air bleed off
- 5 gallon fuel tank
- Clear acrylic safety guard allows for easy inspection
- Hopper capacity: 40 Cubic ft.
- Output:
Fiberglass: 2100 lbs/hour
Cellulose: 3600 lbs/hour

KEY	SKU	DESCRIPTION	WEIGHT (LBS)
B	KM2800G	Blowing Machine, Krendl 2800-G, Gas Powered	1224



C

(C) Krendl 4000-G Blowing Machine

Maximize your production with your 4000-G all fiber machine. Designed for low maintenance and high production, the 4000-G provides a large easy loading hopper while offering simple rugged performance. The 4000-G is intended to function as a truck mount machine for the professional contractor.

Specifications:

- Removable all steel airlock allows quick access for maintenance
- 18 HP Briggs & Stratton V-Twin engine w/positive pressure lubrication system
- 12 volt Magnetron R Electronic Ignition system
- Convertible fold down loading door
- Large Hopper capacity: 62 Cubic ft.
- Output:
Fiberglass: 2200 lbs/hour
Cellulose: 4800 lbs/hour

KEY	SKU	DESCRIPTION	WEIGHT (LBS)
C	4000G	Blowing Machine, Krendl 4000-G, Gas Powered	1460

BLOWING MACHINES



(A) INSULMAXX - IM1000 Blowing Machine

Small, rugged & portable, this is the perfect machine for the D-I-Y application, fireproofing patcher, or a recycle machine for wall spray.
Specifications:

- Drive Motor: 1/8 HP Gear Reduction
- Blower Motor: 3/4 HP
- Power requirements: 1 - 15 amp 110 VAC circuit
- Outlet Size: 2.5"
- Airlock: 18" x 6"
- Size: 36"H x 24"W x 22"D
- Hopper Capacity: 5 Cubic ft.
- Output: 750 lbs per hour (cellulose)

KEY	SKU	DESCRIPTION	WEIGHT (LBS)
A	IM1000	Blowing Machine, InsulMaxx 1000 (115 Vac)	120

(B) INSULMAXX - IM2000 Blowing Machine

An excellent insulation machine for the contractor who is just starting in the business. Double agitators assure smooth and accurate fiber conditioning. Variable air pressure, 18" airlock for blowing or spraying.
Specifications:

- Drive Motor: 1 HP
- Blower Motor: 1.5 HP
- Power Requirements: 2-15 amp 115 VAC circuits
- Control System: 24 Vdc w/100' Remote
- Outlet Size: 2.5"
- Airlock: 18" x 6"
- Size: 48"H x 24"W x 22"D
- Hopper Capacity: 8 Cubic ft.
- Output:
 - Cellulose: 1,350 lbs per hr
 - 1,000 Sq ft per hr (2" x 4" wall spray)
 - Fiberglass: 300 lbs per hr
 - Rockwool: Results vary by manufacturer

KEY	SKU	DESCRIPTION	WEIGHT (LBS)
B	IM2000	Blowing Machine, InsulMaxx 2000 (2, 115 Vac)	160

(C) INSULMAXX - IM4000 Blowing Machine

The InsulMaxx 4000 is the highest production 115Vac electric all-fiber machine available. Includes 2 HP air pressure system with high precision conditioning cards and a material feed control unit.
Specifications:

- Drive Motor: 1 HP
- Blower Motor: 1-2 HP
- Power Requirements: 2-15 amp 115 VAC circuits
- Control System: 24Vdc w/100' Remote
- Outlet Size: 3"
- Airlock: 10" x 10"
- Size: 56"H x 38"W x 26"D
- Hopper Capacity: 14 Cubic ft.
- Output:
 - Cellulose: 1800 lbs per hr
 - 1,100 Sq ft per hr (2" x 4" wall spray)
 - Fiberglass: 450 lbs per hr
 - Rockwool: Results vary by manufacturer

KEY	SKU	DESCRIPTION	WEIGHT (LBS)
C	IM4000	Blowing Machine, InsulMaxx 4000 (2, 115 Vac)	390

(D) INSULMAXX - IM5000 Blowing Machine

Approved for use with industrial coatings and all fireproofing fibers. Includes a specialized 2-step agitation system, using auger style paddles followed by a series of conditioning cards. Variable speed drive system ensures high volume production utilizing two 2 HP blowers, allowing control for smooth spraying.
Specifications:

- Drive Motor: 1.5 HP
- Blower Motor: 2-2 HP blower
- Power Requirements: 1-20 amp 220 VAC circuit
- Control System: 24Vdc w/100' Remote
- Outlet Size: 3"
- Airlock: 10" x 10"
- Size: 56"H x 38"W x 26"D
- Hopper Capacity: 14 Cubic ft.
- Output:
 - Cellulose: 2,100 lbs per hr
 - 1,200 Sq ft per hr (2" x 4" wall spray)
 - Fiberglass: 600 lbs per hr
 - Rockwool: Results vary by manufacturer

KEY	SKU	DESCRIPTION	WEIGHT (LBS)
D	IM5000	Blowing Machine, InsulMaxx 5000 (220 Vac)	430

Note: The IM2000, IM4000 and IM5000 come with material conditioning cards, 100' of remote cord, an IMRS1000 2-way remote switch and owner's manual.



A



B



C

(A) FiberForce Tall Hopper w/Accessories

The ultimate machine for portability provides installers a compact machine with a detachable hopper for ease of transporting. Wireless remote, 1-15 amp circuit for complete operation.

Specifications:

- Hose - 2-1/2" x 50' (included)
- Wireless remote (range) - 250' (included)
- Gear motor - .38 HP @ 82 RPM
- Gear motor torque - 296 in/lb
- Blower (single stage) - 145 cfm / 2.8 psi
- Electrical- 115 VAC @ 14 amps 1610 Watts
- Power cord, type SJO (twist lock) - 14/3 x 50' (included)
- Output:
Cellulose: 1,050 lbs per hr
Fiberglass: 400 lbs per hr
Results vary by manufacturer

KEY	SKU	DESCRIPTION	MIN QTY
A	FFHOPPER	FiberForce Tall Hopper w/Accessories	each

(B) Force/2 High Power Next Generation

The ultimate machine for portability provides installers a compact machine with a detachable hopper for ease of transporting. Wireless remote, 1-15 amp circuit for complete operation.

Specifications:

- Dimensions- 30.25"D x 44.75"H
- Remote Cord- 18/4 x 100'
- Optional Wireless remote - Up to 250'
- Hopper Capacity - 9 cu. ft.
- Optional Hopper Ext - 13 cu. ft.
- Transmission - Custom, Direct drive
- Airlock- 12" Steel
- Blower: 115 VAC - 15 amp input, 2-stage generates over 6 psi at sea level
- Agitator motor: 1-1/2 HP 115 VAC - 15 amp input
- Output:
Cellulose: 2,400 lbs per hr
Fiberglass: 700 lbs per hr
Rockwool: 2,100 lbs per hr
Results vary by manufacturer

KEY	SKU	DESCRIPTION	MIN QTY
B	F257HD	Force/2 - Requires 2 Straight Blade Power Cords	each
	F257HDW	Force/2 - Requires 2 Straight Blade Power Cords	each

Power Cords – Twist Lock

Twist lock, heavy duty all weathered power cords for use with Intec Blowing machines.

KEY	SKU	DESCRIPTION	MIN QTY
	PWRCD100TL	100' 12/3 – works with the TFHPMAX	each
	PWRCD50TL	50' 12/3 – works with the TFHPMAX	each

(C) Intec Turbo Force HP3 Wireless

The TURBO FORCE provides users with production rates similar to truck mount systems, with the performance and precision of an Intec portable system. These units have it all for the demanding professional. Large 17 cubic foot hopper & large loading platform, dual agitation for aggressive feed and conditioning, impressive production with best-in-class wall fill rates, and Intec Quick-Access design features - including revolutionary tilt-back design—to keep your uptime at a maximum.

Specifications:

- Electrical: 115 VAC
3 - 15 amp circuits with hP3
2 - 15 amp & 1-20 amp circuit with hP MAX
- Industrial Wireless Remote with 250' operating range
- TFHP3 Output:
Cellulose: 2,475 lbs per hr
Fiberglass: 900 lbs per hr
Rockwool: 2,460 lbs per hr
Results vary by manufacturer
- TFHP MAX Output:
Cellulose: 3,200 lbs per hr
Fiberglass: 1,200 lbs per hr
Rockwool: 3,150 lbs per hr
Results vary by manufacturer
- Agitator motor: TURBO FORCE & hP3: ½ HP, 115 VAC, 7.1 amp
TURBO FORCE hP MAX: ¾ HP, 115 VAC, 9.5 amp
- Airlock motor: TURBO FORCE & hP3: ½ HP, 115 VAC, 7.1 amp
TURBO FORCE hP MAX: 1 HP, 115 VAC, 7.8 amp

• Power cords not included

KEY	SKU	DESCRIPTION	MIN QTY
C	TFHP3W	HP3 Wireless - Requires 3 Straight Blade Power Cords	each
	TFHPMAX	HP3 Max Wireless - Requires 2 Straight Blade Power Cords and 1 Twist Lock Power Cord	each

Power Cords – Straight Blade

Straight blade, heavy duty all weather power cords for use with Intec Blowing Machines.

KEY	SKU	DESCRIPTION	MIN QTY
	PWRCD100SB	100' 12/3 – works with F257HD, F257HDW, TFHP3W and TFHPMAX	each
	PWRCD50SB	50' 12/3 – works with F257HD, F257HDW, TFHP3W and TFHPMAX.	each

BLOWER ACCESSORIES

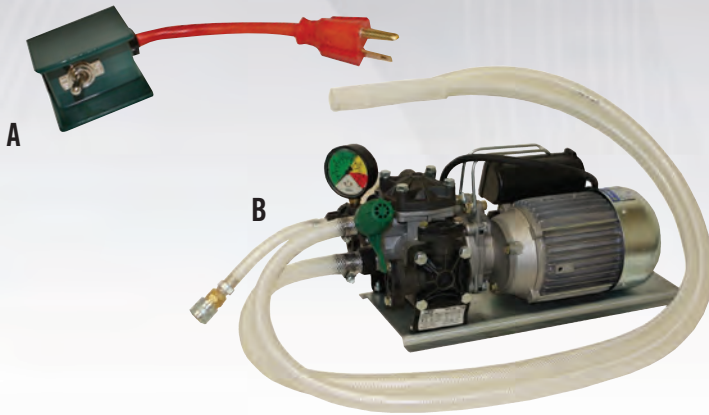

(A) Sprayco 2-Way Remote Switch

2-way remote switch for controlling the blower; or use with IM2000, IM4000 and IM5000 machines. Pigtail is 8" long.

KEY	SKU	DESCRIPTION	MIN QTY
A	IMRS1000	Sprayco 2-way remote switch	each



(B) Sprayco Direct Drive Diaphragm Pump

1 HP diaphragm is outfitted with 5' of suction hose, 5' of bypass hose. Power requirement: (1) 10 Amp, 110 Vac circuit. Maximum pressure: 240 psi. Max flow: 4.4 gpm

KEY	SKU	DESCRIPTION	MIN QTY
B	DDP1000	Sprayco diaphragm pump	each



(C) High Pressure Hose Kits

For use with Sprayco Diaphragm Pump, SKU DDP1000. Includes 5' suction hose, 5' delivery hose, high pressure hose and filter.

KEY	SKU	DESCRIPTION	MIN QTY
C	PHK100	High pressure hose kit, 100'	each
	PHK150	High pressure hose kit, 150'	each

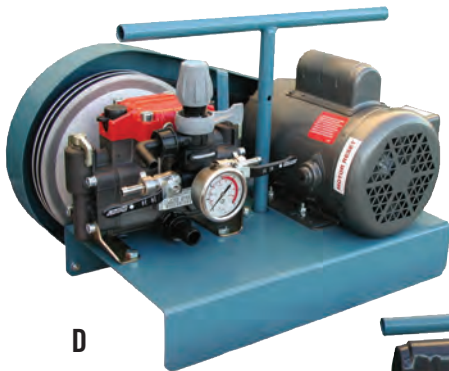

(D) MP-20 Pump and Motor

High quality, double belt-driven pump with 1 HP TEFC motor offers easy, reliable operation. Ideal for the entry level contractor as well as the professional contractor. Maximum flow: 5.7 gpm. Maximum pressure: 180 psi. Maximum speed: 650 rpm.

KEY	SKU	DESCRIPTION	MIN QTY
D	WS120	MP-20 Pump and motor	each



(E) M-3 Pump and Motor

Economical direct drive self priming, triple diaphragm pump with a 1 HP TEFC motor. Ideal for the entry level contractor as well as the professional contractor. Maximum flow: 3 gpm. Maximum pressure: 300 psi. Maximum speed: 1,725 rpm.

KEY	SKU	DESCRIPTION	MIN QTY
E	WS030	M-3 Pump and motor	each

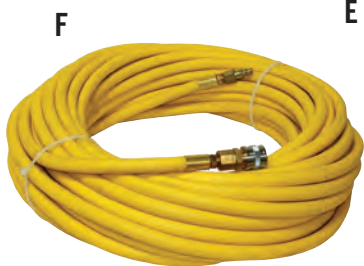

(F) Sprayco Water Hose

KEY	SKU	DESCRIPTION	MIN QTY
F	WH50	Water hose, 3/8" X 50' (300 psi max)	each
	WH100	Water hose, 3/8" X 100' (300 psi max)	each
	WH150	Water hose, 3/8" X 150' (300 psi max)	each
	WH200	Water hose, 3/8" X 200' (300 psi max)	each



(G) InsulMaxx Blowing Machine Air Filter

KEY	SKU	DESCRIPTION	MIN QTY
G	IMF1000	InsulMaxx Blowing Machine Air Filter	each



(H) Wall Tubing

Available in winter and summer grades. Wall tubing attaches to the tip of a reducing nozzle, allowing the hose to be fed into a wall cavity and then pulled out as the wall cavity fills up with insulation.

KEY	SKU	DESCRIPTION	MIN QTY
H	ST100	1" ID, 1-1/4" OD, Summer Style	per foot
	ST125	1-1/4" ID, 1-1/2" OD, Summer Style	per foot
	WT100	1" ID, 1-1/4" OD, Winter Style	per foot
	WT125	1-1/4" ID, 1-1/2" OD, Winter Style	per foot
	WT150	1-1/2" ID, 2" OD, Winter Style	per foot
	WT200	2" ID, 2-1/2" OD, Winter Style	per foot

MOISTURE METERS

(A-B) Moisture Meters

The perfect tool for making sure the moisture level in a sprayed wall is within the acceptable range. The analog meter is great for testing moisture in sprayed fiberglass and rockwool, while the LED meter is perfect for cellulose spray applications.

KEY	SKU	DESCRIPTION	MIN QTY
A	MM100	Moisture meter, analog (reads up to 40%)	each
B	MM200	Moisture meter, LED (reads up to 90%)	each



(C) Graphite Powder

Reduces static electricity and friction. Occasionally blend one or two cans with cellulose and run through the blower and hose.

KEY	SKU	DESCRIPTION	MIN QTY	QTY/CASE
C	PG430	Graphite powder—16 oz can	1 can	12

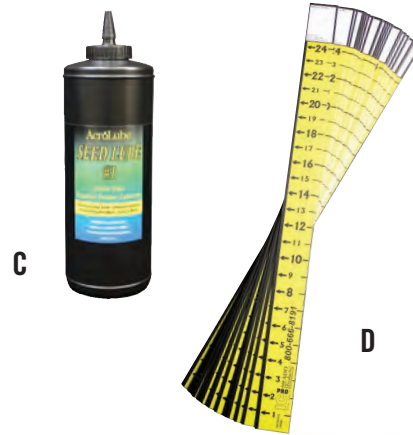

(D) Attic R-Value Rulers

Highly visible attic rulers are printed on one side and now measure up to 24" of insulation. Offered in two thicknesses: The RT240HD, Heavy Duty version, is nearly twice as thick.

KEY	SKU	DESCRIPTION	QTY/BOX
D	RT240	24" Standard R-Value Rulers	250
	RT240HD	24" Heavy Duty R-Value Rulers	200

WATER INJECTION SLEEVES

(E) Hydra-cone Water Injection Sleeves

Hydra-cone water injection sleeves are used for dust suppression, fireproofing and stabilizing applications. Available in 2" through 4". Comes with low pressure (25-50 psi) internal tip. High pressure tips (100 psi and above) available upon request.

KEY	SKU	DESCRIPTION	MIN QTY
E	14025	Sprayco Nozzle 2.5" Hydra-cone Water Injection Sleeve	each
	14030	Sprayco Nozzle 3" Hydra-cone Water Injection Sleeve	each
	14040	Sprayco Nozzle 4" Hydra-cone Water Injection Sleeve	each

(F-G) Sprayco Nozzle, 4" Standard Water Sleeve (4003)

Perfect for dust suppression and stabilizing cellulose.

KEY	SKU	DESCRIPTION	MIN QTY
F	HOS116	Sprayco Nozzle, 3" Standard Water Sleeve	each
G	HOS149	Sprayco Nozzle, 4" Standard Water Sleeve (4003)	each

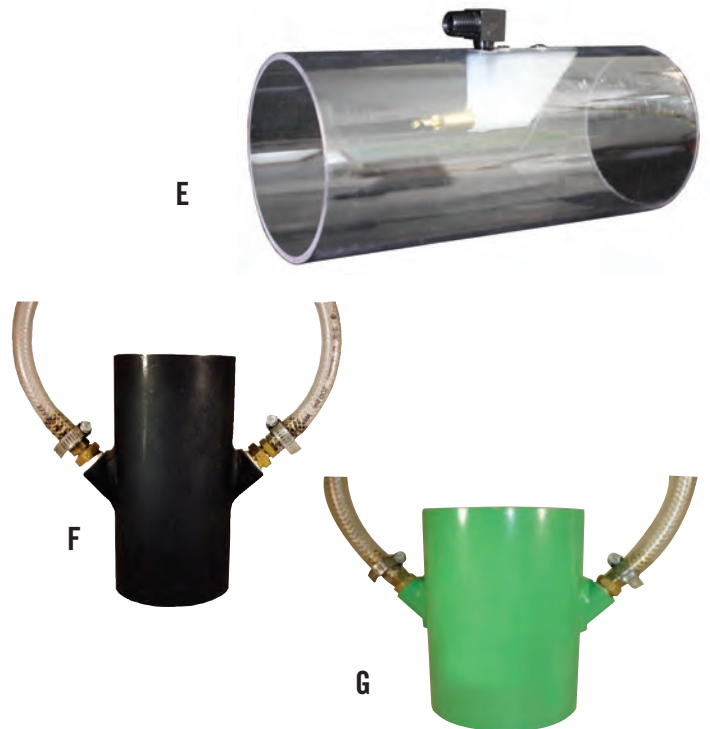

HOLE SAWS & BITS



Relton Tooth Hole Saws

Ideal for cutting holes to install fiberglass, cellulose and other injected insulation. Carbide tips are brazed to the hole saw body with special high-temperature silver solder. Elongated slots allow easy plug removal. Consistently cut round holes are easily patched with wood or plastic plugs. Complete saws include cutter head, shank and carbide pilot.

(A) Relton Carbide-Tooth Stucco Hole Saws

Stucco saw cuts stucco, mesh, asbestos or aluminum siding.

KEY	SKU	DESCRIPTION	MIN QTY
A	RSS100	Relton carbide-tipped stucco saw—1"	each
	RSS113	Relton carbide-tipped stucco saw—1-1/8"	each
	RSS125	Relton carbide-tipped stucco saw—1-1/4"	each
	RSS150	Relton carbide-tipped stucco saw—1-1/2"	each
	RSS200	Relton carbide-tipped stucco saw—2"	each
	RSS213	Relton carbide-tipped stucco saw—2-1/8"	each
	RSS250	Relton carbide-tipped stucco saw—2-1/2"	each
	RSS300	Relton carbide-tipped stucco saw—3"	each
	RSB200	Relton carbide-tipped stucco saw—2" Head Only	each
	RSB250	Relton carbide-tipped stucco saw—2-1/2" Head Only	each

(B) Relton Steel-Tooth Wood Hole Saws

Wood saw works best in any type wood, including particle board.

KEY	SKU	DESCRIPTION	MIN QTY
B	RWS100	Relton carbide-tipped wood saw—1"	each
	RWS113	Relton carbide-tipped wood saw—1-1/8"	each
	RWS125	Relton carbide-tipped wood saw—1-1/4"	each
	RWS150	Relton carbide-tipped wood saw—1-1/2"	each
	RWS200	Relton carbide-tipped wood saw—2"	each
	RWS213	Relton carbide-tipped wood saw—2-1/8"	each
	RWS250	Relton carbide-tipped wood saw—2-1/2"	each
	RWS300	Relton carbide-tipped wood saw—3"	each
	RWB250	Relton carbide-tipped wood saw—2-1/2" Head Only	each
	RWB300	Relton carbide-tipped wood saw—3" Head Only	each

(C-E) Relton Hole Saw Replacement Parts

KEY	SKU	DESCRIPTION	MIN QTY
C	RSP025	Relton pilot (for less than 2")—1/4" Carbide	each
	RSP142	Relton pilot (for less than 2")—1/4" Steel	each
	RSP038	Relton pilot (for 2" and more)—3/8" Carbide	each
	RSP382	Relton pilot (for 2" and more)—3/8" Steel	each
D	RES100	Relton shank—1/4"	each
	RES200	Relton shank—3/8"	each
E	RES042	Relton ejector spring (for less than 2")	each
	RES062	Relton ejector spring (for 2" and more)	each

ASBESTOS CUTTER

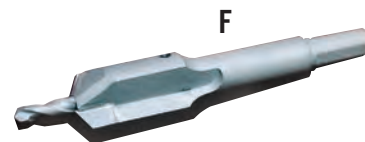

(F) Asbestos Cutter Bit

Rugged bits, best for asbestos siding. Built to be sharpened repeatedly. Comes with carbide pilot.

KEY	SKU	DESCRIPTION	MIN QTY
F	AB100	1" Asbestos bit w/carbide pilot	each



(G-H) Hole Saw Replacement Parts

KEY	SKU	DESCRIPTION	MIN QTY
G	PBC475	Pilot bit—4-3/4" carbide tipped	each
	PBHS313	Pilot bit—3-1/8" hole saw, high-speed steel	each
	MHS38	Hole saw mandrel—3/8"	each
H	MHS12	Hole saw mandrel—1/2"	each

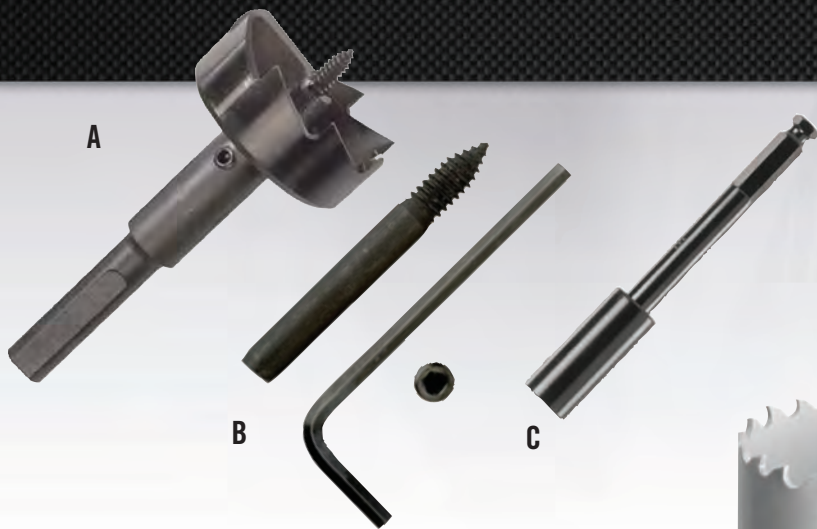

Wood Boring System

One-piece construction bits with cutter blades welded to shanks. They are self-feeding with one replaceable pilot screw that fits all sizes, eliminating the need to match parts. The black oxide finish is rust resistant. The easy to use, fast cutting bits won't separate when backing out, and they're easy to sharpen with only two cutters.

(A) Self Feed Wood Bits

Automatic-feed wood bits feature outside diameter threads and replaceable lead screws.

KEY	SKU	DESCRIPTION	MIN QTY
A	SFWB1	Bit—1" self-feed, wood	each
	SFWB125	Bit—1-1/4" self-feed, wood	each
	SFWB150	Bit—1-1/2" self-feed, wood	each
	SFWB2	Bit—2" self-feed, wood	each
	SFWB2125	Bit—2-1/8" self-feed, wood	each
	SFWB256	Bit—2-9/16" self-feed, wood	each

(B-C) Wood Bit Replacement Parts

KEY	SKU	DESCRIPTION	MIN QTY
B	RSFK18	Replacement kit, self feed 1/8"	each
C	ESFB6	Extension, 6", 7/16" shank (3/pk)	each
	ESFB12	Extension, 12", 7/16" shank	each

Hole Saws

Long-lasting carbide-tipped and bi-metal hole saws. Arbor, standard and carbide-tipped pilots sold separately.

(D) Bi-Metal Hole Saws

Bi-metal construction with a high-speed steel cutting edge. Vari-Tooth design creates sharper tooth tips for faster, freer cutting. Cutting depth is 1-1/2". Positive rake tooth creates a more aggressive cutting action than conventional tooth styles.

KEY	SKU	DESCRIPTION	MIN QTY
D	BHS1	Bi-metal hole saw—1"	each
	BHS1125	Bi-metal hole saw—1-1/8"	each
	BHS125	Bi-metal hole saw—1-1/4"	each
	BHS150	Bi-metal hole saw—1-1/2"	each
	BHS2	Bi-metal hole saw—2"	each
	BHS206	Bi-metal hole saw—2-1/16"	each
	BHS2125	Bi-metal hole saw—2-1/8"	each
	BHS250	Bi-metal hole saw—2-1/2"	each
	BHS256	Bi-metal hole saw—2-9/16"	each
	BHS3	Bi-metal hole saw—3"	each

(E-K) Bi-Metal Hole Saw Parts

KEY	SKU	DESCRIPTION	MIN QTY
E	PBHS313	High Speed Steel Pilot Bit, 3-1/8"	each
F	PBC475	Carbide Tipped Pilot Bit, 4-3/4"	each
G	MHS12	Quick Change Mandrel, 1/2" shank	each
H	MHS38	Quick Change Mandrel, 3/8" shank	each
I	MHS916	Standard Mandrel, 3/8" shank fits hole saws 9/16" to 6", 3/8" shank	each
J	AHS916	Quick Change Adaptor, fits hole saws 9/16" to 1-3/16"	each
K	AHS125	Quick Change Adaptor, fits hole saws 1-1/4" to 6"	each



BOSCH



A

(A) Long Nose Plastic Plugs

Exceptional design. With a 5/8" shank and heavy gripping teeth, this plug will hold in both single and multiple layers of siding. Extra wide cap has a tapered edge for obscured vision on siding and a textured tip for easy painting.

KEY	SKU	DESCRIPTION	QTY/BAG
A	LS100B	Long nose plastic—1"	500
	LS125B	Long nose plastic—1-1/4"	250
	LS150B	Long nose plastic—1-1/2"	250
	LS200B	Long nose plastic—2"	250



B

(B) Regular Plastic Plugs

Paintable matte finish with a 3/8" shank and two clips on each side for a firm grip in aluminum, vinyl and steel siding.

KEY	SKU	DESCRIPTION	QTY/BAG
B	SP100B	Regular plastic—1"	500
	SP125B	Regular plastic—1-1/4"	250
	SP150B	Regular plastic—1-1/2"	250
	SP200B	Regular plastic—2"	250
	SP213BLB	Regular plastic, black—2-1/8"	250
	SP250B	Regular plastic—2-1/2"	250
	SP300BL	Regular plastic, black—3"	100



C

(C) Foam (Styrofoam) Plugs

Styrofoam plugs are used for holes in drywall and are recessed to accept spackling compound. They absorb little moisture, thus require fewer layers of spackling for a smooth finish.

KEY	SKU	DESCRIPTION	QTY/BAG
C	FP100B	Foam—1"	1000
	FP150B	Foam—1-1/2"	1000
	FP200B	Foam—2"	1000
	FP213B	Foam—2-1/8"	1000
	FP250B	Foam—2-1/2"	750
	FP256B	Foam—2-9/16"	750
	FP279B	Foam—2-5/8"	750
	FP300B	Foam—3"	500



D

(D) Pine Wood Plugs

Unlike other plugs, which are completely tapered, these wood plugs are slightly tapered over only 7/8 of the total thickness for easy insertion. The top 1/8 is the full diameter measurement for a tight, even fit. Made from kiln-dried lumber and produced on specially designed equipment for consistent high quality.

KEY	SKU	DESCRIPTION	QTY/BAG
D	WP100B	Pine—1"	250
	WP125B	Pine—1-1/4"	175
	WP150B	Pine—1-1/2"	125
	WP200B	Pine—2"	250
	WP201B	Pine, std—2" †	250
	WP213B	Pine—2-1/8"	250
	WP225B	Pine—2-1/4"	225
	WP250B	Pine—2-1/2"	175
	WP256B	Pine—2-9/16"	175
	WP300B	Pine—3"	125

† For use with Milwaukee hole saws.

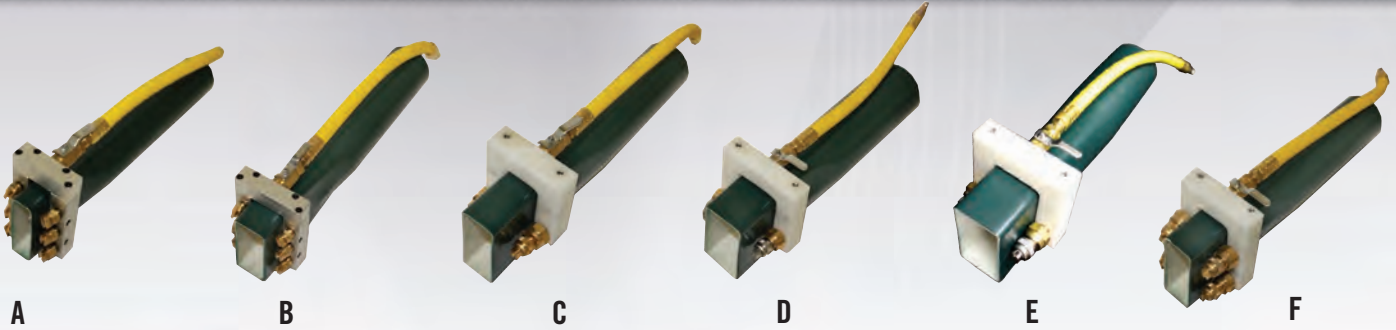

(A-F) Sprayco Wet-Spray Nozzles

KEY	SKU	DESCRIPTION	MIN QTY
A	14100	Wet Spray Nozzle—2" - 6 Jet	each
B	14101	Wet Spray Nozzle—2-1/2" - 6 Jet	each
C	14202Q	Wet Spray Nozzle—2-1/2" - 2 Jet, quick disc	each
D	14203	Wet Spray Nozzle—3" - 2 Jet, stainless steel	each
E	14203Q	Wet Spray Nozzle—3" - 2 Jet, stainless quick disc	each
F	14402Q	Wet Spray Nozzle—2-1/2" - 4 Jet, quick disc	each

14100 - This 2", 6-Jet nozzle is perfect for finish spray.

- Includes an aluminum water manifold
- Comes standard with (6) brass #2501 screw-in style tips

14101 - 2-1/2", 6-Jet nozzle is designed for wall spray.

- Includes an aluminum water manifold
- Comes standard with (6) brass #2501 screw-in style tips

14202Q - 2-1/2", 2-Jet nozzle is designed for wall spray.

- Includes a machined Delrin plastic water manifold
- Comes standard with (2) brass #4002 quick disconnect style tips
- Includes quick change tool for the quick disconnect tips

14203 - 3", 2-Jet nozzle is designed for wall spray.

- Includes an aluminum water manifold
- Comes standard with (2) stainless steel #4001 screw-in style tips

14203Q - 3", 2-Jet nozzle is designed for wall spray.

- Includes a machined Delrin plastic water manifold
- Comes standard with (2) stainless steel #4001 quick disconnect style tips
- Includes quick change tool for the quick disconnect tips

14402Q - 2-1/2", 4-Jet nozzle is designed for wall spray.

- Includes a machined Delrin plastic water manifold
- Comes standard with (2) brass #4001 quick disconnect style tips on the bottom and (2) brass #2501 quick disconnect style tips on the top
- Includes quick change tool for the quick disconnect tips

(G) Krendl 2-Jet Wet-Spray Wall Cavity Nozzles

Wide oval discharge allows for maximum flow of coarse, wet, recycled fibers without plugging. Rigid attachment of spray tip body to internally machined head eliminates misalignment and nuisance pressure tubing leaks caused by frequent accidental impacts. Quick-connect tips sold separately—QD202, #2502 standard.

KEY	SKU	DESCRIPTION	MIN QTY
G	WS202W	Krendl 2-jet nozzle—2"	each
	WS252W	Krendl 2-jet nozzle—2-1/2"	each
	WS320W	Krendl 2-jet nozzle—3"	each

Note: Please consult your Insulation Account Manager for additional specifics on wet spray nozzle tips. Requirements vary by Insulation Manufacturer.

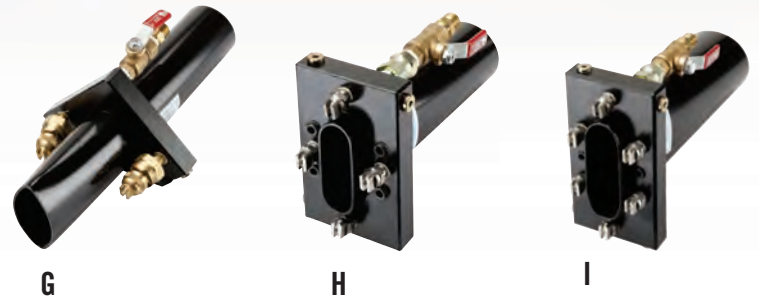

(H-I) Krendl 4-Jet and 6-Jet Wet-Spray Commercial Nozzles

Narrow, flat orifice increases dispersing, velocity and impact of fiber. This will maintain a flat, smooth flowing spray pattern which will fully encapsulate the fibers. Stainless steel, screw-in style tips #4002 standard, sold separately.

KEY	SKU	DESCRIPTION	MIN QTY
H	WS204C	Krendl 4-jet commercial nozzle—2"	each
	WS254C	Krendl 4-jet commercial nozzle—2-1/2"	each
I	WS256C	Krendl 6-jet commercial nozzle—2-1/2"	each



*Krendl Wet-Spray Tips
Base adapter*



*Krendl Wet-Spray Tips
Brass Quick-Connect*



*Krendl Wet-Spray Tips
Stainless Steel Screw-In*

Krendl Wet-Spray Tips—Brass Quick-Connect

SKU	DESCRIPTION	MIN QTY
QD200	Base adapter	each
QD201	#2501	each
QD215	#25015	each
QD202	#2502	each
QD203	#2503	each
QD401	#4001	each
QD415	#40015	each
QD402	#4002	each

Krendl Wet-Spray Tips—Stainless Steel Screw-In

SKU	DESCRIPTION	MIN QTY
WS301	#1501	each
WS303	#4001	each
WS302	#40015	each
WS300	#4002	each
WS304	#4008	each

Wolverine Vacuums

This badboy handles anything—blown-in insulation, cellulose, scraped-off foam and plaster chips—wet or dry, for excellent all-around performance. Material intended for recycling can even be directed to a blowing machine for reuse. Waste material can be discharged directly into a disposable collection bag.

The Wolverine's rugged construction and quality components mean longer engine life and less downtime—exactly what you should expect from an industry leader.

Oil will be installed before shipping, but always check for proper level before use.

Why choose a Wolverine?

- 2-year Kohler engine warranty
- Dynamically balanced impeller and shaft, heavy duty 1" bore, 16" OD, and 3/16" steel blades that increase suction pressure for smooth, dependable operation.
- Designed with a removable front panel, it's easy to service and clean impeller blades.
- Integrated exhaust system and a silenced air intake for quiet, low decibel operation.
- Large-capacity fuel tank allows for longer run times with less refueling.
- Electronic ignition system with automatic compression release for easy starting.
- Cast iron sleeve, a steel-forged crankshaft and rebuildable cylinder for long life.
- Dual-element air filter and heavy 10-gauge welded steel for strength and long life.
- Either a 4" or 6" inlet/outlet for greater productivity.
- Oil sentry protection and a dual side oil drain and fill for convenience.
- Swirl induction combustion chamber for increased power with less fuel.



(A) Wolverine WV300HD Vacuum

- 14 HP Kohler OHV with 12Vdc electric start and battery (includes a 2-year warranty on the Kohler engine)
- 4" Inlet and outlet tubes
- Heavy duty impeller

KEY SKU	DESCRIPTION	WEIGHT (LBS)
A WV300HD	Wolverine—14 HP, HD impeller, 4"	250

Wolverine WV300HD6 Vacuum

- 14 HP Kohler OHV with 12Vdc electric start and battery (includes a 2-year warranty on the Kohler engine)
- 6" Inlet and outlet tubes
- Heavy duty impeller

SKU	DESCRIPTION	WEIGHT (LBS)
WV300HD6	Wolverine—14 HP, HD impeller, 6"	250

Complete Vacuum Accessory Kits

SKU	DESCRIPTION
WVAKN	4" Inlet/Outlet complete package, includes: 3 (MK4050) Mark II clear hose—4" x 50' 2 (SC400) Steel connector—4" 6 (CL400) Hose clamp—4" 1 (WV101) 48" Suction tube attachment 1 (450TB049) Vacuum bags (5 bags)
WVAK6N	6" Inlet/Outlet complete package, includes: 6 (FT6025) Urethane Flex hose—6" x 25' 5 (SC600) Steel connector—6" 12 (CL600) Hose clamp—6" 1 (WV101) 48" Suction tube attachment 1 (450TB049) Vacuum bags (5 bags) 1 (RC640) Steel reducer—6" to 4"

Wolverine Impeller

SKU	DESCRIPTION	MIN QTY
WV10001	Vacuum Part, Wolverine Impeller	each

(A) Krendl KV180 Vacuum

- 18 HP Briggs & Stratton gas engine, electric start
- 6" inlet and outlet tubes
- 18" steel fan, production of 7000 lbs/hour

KEY SKU	DESCRIPTION	WEIGHT (LBS)
A KV180	Krendl—18 HP, 6"	240



(B) Krendl KV230 Vacuum

- 23 HP Briggs & Stratton gas engine
- Belt driven
- 6" inlet and outlet tubes
- 18" steel fan, production of 9000 lbs/hour

KEY SKU	DESCRIPTION	WEIGHT (LBS)
B KV230	Krendl—23 HP, 6"	331



(C) Krendl Vacuum Defender

Designed to remove potentially damaging debris before it comes in contact with the vacuum fan blades. Innovative design reduces wear and tear—prolonging the life of your vacuum.

- 6" inlet and outlet tubes
- Reducer kit available

KEY SKU	DESCRIPTION	WEIGHT (LBS)
C KVDEFENDER	Krendl Vacuum Defender	60



Krendl Vacuum Defender Reducer Kit

Includes: 6" to 4" reducer; 4" clamp; 6" clamp; 6" connector hose

KEY SKU	DESCRIPTION	MIN QTY
KV180KIT	Krendl Reducer Kit	each



(D) 18 HP Krendl Impeller

KEY SKU	DESCRIPTION	MIN QTY
D KV102	Vacuum Part, 18 & 23 HP Krendl Impeller	each

(E-G) Krendl Stud Scrubbers

120Vac, 1/8 HP TEFC motor, belt-driven rubber rollers with tensioners. Used to remove excess spray-on insulation between wall studs, allowing for easy installation of drywall. The 27" wide scrubber is for use on 24" OC, the 18" width for 16" OC. Works well in closets or congested areas.

KEY SKU	DESCRIPTION	MIN QTY
E KS160	Krendl stud scrubber—18"	each
KS240	Krendl stud scrubber—27"	each
F KS160V	Krendl stud scrubber, vertical—18"	each
KS240V	Krendl stud scrubber, vertical—27"	each
KS290V	Krendl stud scrubber, vertical—18" w/30" extension	each
KS300V	Krendl stud scrubber, vertical—27" w/30" extension	each
G KS290	Krendl stud scrubber—18" w/30" extension	each
KS300	Krendl stud scrubber—27" w/30" extension	each

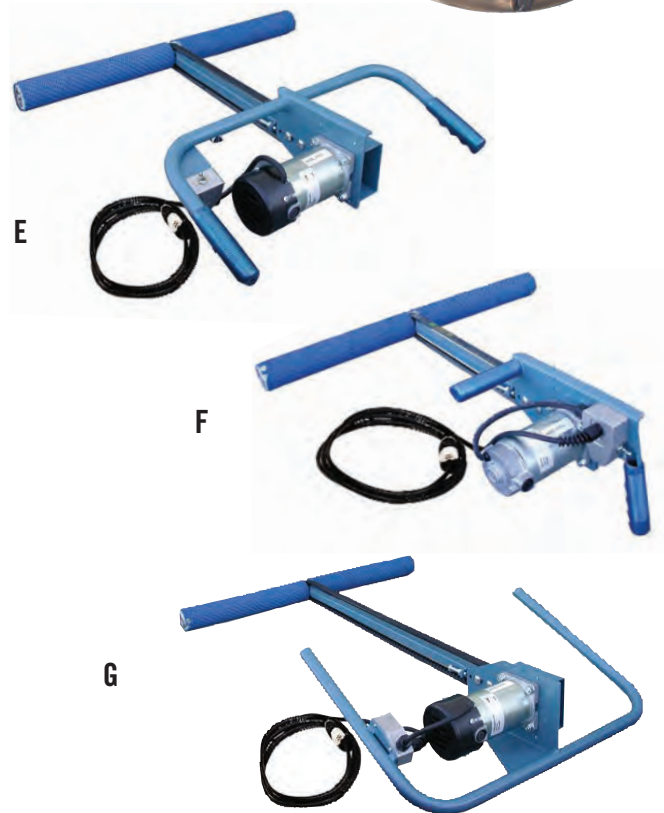

Krendl Stud Scrubber Accessories

SKU	DESCRIPTION	MIN QTY
KS161	18" Roller assembly	each
KS241	27" Roller assembly	each
KS242	28" Belting (2 per set)	each
KS243	17" Belting (2 per set)	each
KS245	Scrubber motor	each

BLOWING & EXTRAS

(A-B) Sprayco Wall Scrubbers

27" Wall scrubbers available with a battery powered 18Vdc DeWalt drill or a corded 110Vac DeWalt drill. Please specify the preferred power source at point of ordering.

- Drills can be removed and replaced very easily
- Both styles can be ordered with a nylon brush or rubber rollers.
- Nylon brush is perfect for cellulose and the rubber roller for fiberglass

KEY	SKU	DESCRIPTION	MIN QTY
A	SC2400R	Sprayco wall scrubber—27" rubber roller	each
	SC2400N	Sprayco wall scrubber—27" nylon brush (not shown)	each
B	SC2400BPN	Sprayco battery powered—27" nylon brush	each
	SC2400BPR	Sprayco battery powered—27" rubber roller (not shown)	each

Sprayco Wall Scrubber Accessories

SKU	DESCRIPTION	MIN QTY
SCB100	Rubber roll assembly	each
SCB200	Nylon brush roll assembly	each
QCPADS	Quick change rubber rollers	each
SCCOIL	Replacement nylon brush	each
SCBELT	Orange urethane belt	each
SCP214	Drill pulley	each
SCSW100	Switch	each
DM200	Drill motor, 110 Vac, corded	each
DM300A	Drill motor, 18 Vdc, battery powered	each

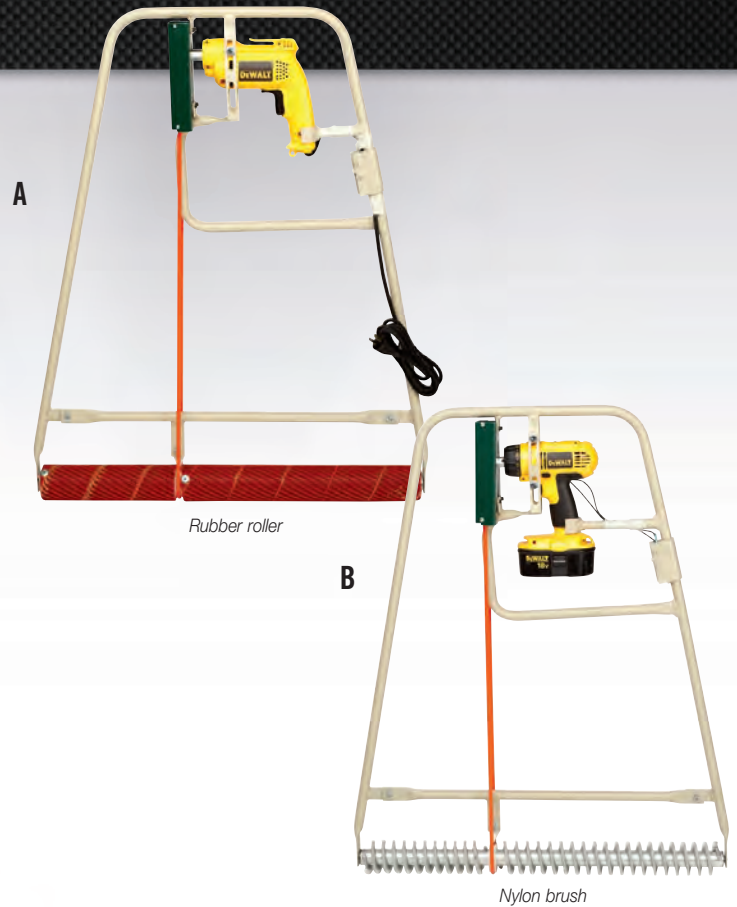

(C-D) Vacuum Bags and Suction Tube

KEY	SKU	DESCRIPTION	MIN QTY
C	450TB049	Vacuum bags—75 cu ft (5 bags/box)	1 box
D	WV101	48" Suction tube attachment	each



(E) Utility Knife Blades

USA made of the finest quality steel. In boxes of 100 blades, they come wrapped in five-blade packages for safety and convenience.

KEY	SKU	DESCRIPTION	MIN QTY
E	UB100	Utility blades, standard size, 5/pkg, 20 pkg/box	1 box

(F) OLFA XHD Cutter Knife

Extra heavy-duty sure grip cutter features a ratchet wheel blade lock to prevent slipping, a rubber grip insert for positive handle control and a rope loop. Knife body is GUARANTEED FOREVER.

KEY	SKU	DESCRIPTION	MIN QTY
F	UKH1	OLFA XHD cutter w/rubber grip insert	each

(G) OLFA XHD Retractable Blades

Extra heavy-duty snap-off replacement blades. Each blade is produced using OLFA's precise multi-step production process for amazing sharpness and superior edge retention. Easily handles cutting through difficult materials. Seven cutting edges per blade strip. 20-pack features 140 cutting edges.

KEY	SKU	DESCRIPTION	MIN QTY
G	UB20B	OLFA XHD blades (20/pkg)	1 pkg

(A) Fixed Blade Utility Knife

Stays in one fixed position with blade extended. All metal heavy-duty handle with blade storage. USA made—high quality.

KEY	SKU	DESCRIPTION	MIN QTY
A	UKFB	Utility knife, fixed blade	each

(B) Retractable Blade Utility Knife

Retracts for safety and convenience. All metal heavy-duty handle with blade storage. USA made—high quality.

KEY	SKU	DESCRIPTION	MIN QTY
B	UKRB	Utility knife, retractable blade	each

(C) Auto Reloading Retractable Utility Knife

Retracts for safety and convenience. It has an auto re-loading feature for quick blade changes and a blade storage area.

KEY	SKU	DESCRIPTION	MIN QTY
C	UKR288P	Utility Knife, auto reloading retractable blade	each

(D-F) Wood Handle Batt Knife

General purpose professional cutting tool. 1" wide high carbon steel blade. Precision machine-ground cutting edge. With smooth wooden handle, this product won't get hung up on the insulation.

KEY	SKU	DESCRIPTION	MIN QTY
D	60450	Batt knife w/wood handle—4"	each
E	60630	Batt knife w/wood handle—6"	each
F	60780	Batt knife w/wood handle—8"	each

(G-H) Black Dragon Batt Knife

General purpose professional cutting tool. 1" wide high carbon steel blade. Precision machine-ground cutting edge. Ergonomically engineered soft grip handles for positive grip and more powerful cutting. Designed with finger stops for maximum leverage and added safety. No-roll handle shape. Textured grip resists sliding in your hand or on inclined surfaces. LIFETIME GUARANTEE that blade will not separate from handle.

KEY	SKU	DESCRIPTION	MIN QTY
G	60110	Black Dragon batt knife—6"	each
H	60115	Black Dragon batt knife—8"	each

(I) Vintool Batt Knife

Designed by an insulation contractor to be "The Best on the Market." It has a 4" replaceable cutting blade with soft grip handle. Blade is seated in utensil with set screws. The end of the handle has a small screw driver mounted in it for convenience when changing blades. Extra blades can be stored in the handle. Comes with 5 blades and cloth sheath that will fit most belts.

KEY	SKU	DESCRIPTION	MIN QTY
I	VT400	Vintool batt knife w/sheath—4"	each

(J) Blades for Vintool Batt Knife

With the storage compartment in the handle of the Vintool you can load an entire tube for quick and easy change outs. USA made.

KEY	SKU	DESCRIPTION	MIN QTY
J	VTBLADE	Vintool blades—4" (10/tube)	1 tube

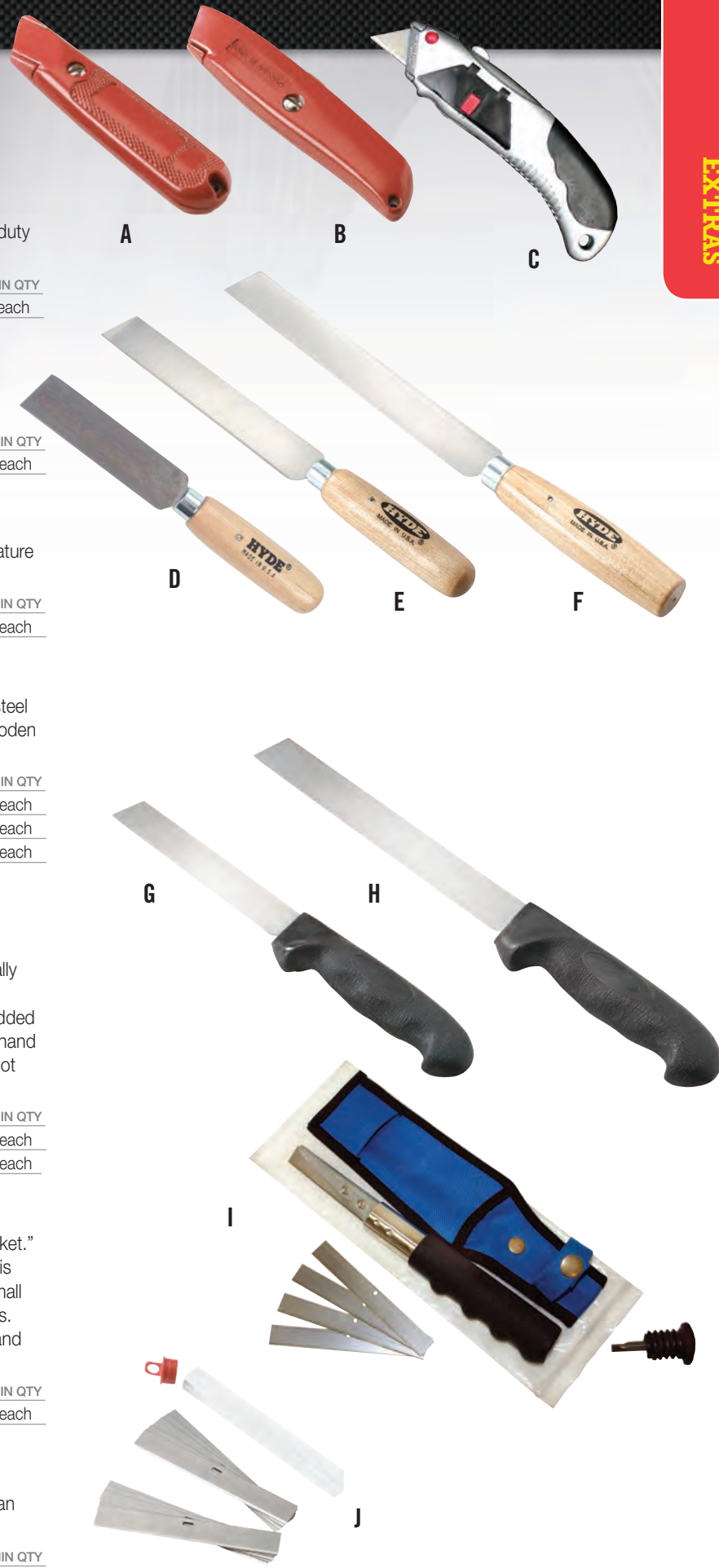

POUCHES, SHEATHS & BACKER ROD



A



B



C



D

(A) 3-Pocket Tool Pouch

Polyester durable fabric, rivet reinforced at all stress points, slot suitable for belts up to 50mm wide.

KEY	SKU	DESCRIPTION	MIN QTY
A	VINYLTP	3-Pocket Tool Pouch	each

(B) Web Belt

Adjusts up to a 48" waist and is 2-1/4" wide.

KEY	SKU	DESCRIPTION	MIN QTY
B	WB100	Web belt	each

(C) Leather Belt

2" wide leather work belt, adjustable to fit sizes up to 46".

KEY	SKU	DESCRIPTION	MIN QTY
C	LB200	Leather belt	each

(D) Leather Batt Knife Sheath

Custom-made and designed to accommodate both 6" and 8" batt knives. It can be used for Black Dragon or wood handle knives. With riveted stress points, this rigid accessory leaves no part of the blade exposed, thus preventing accidental injuries.

KEY	SKU	DESCRIPTION	MIN QTY
D	56500	Leather batt knife sheath—8" x 2"	each

(E) DeWALT 18V Battery Charger

KEY	SKU	DESCRIPTION	MIN QTY
E	DW9116	DeWALT, 18V Battery Charger	each

(F) Headlamps

Includes three LEDs and a xenon bulb in the same reflector. Three-position lighting lets you select the best combination of lights for the task at hand. Powered by 3 "AAA" alkaline batteries (included). 300 mA xenon bi-pin bulb, plus three 100,000-hour life LEDs. 18 lumens typical (xenon); 24 lumens typical (3 LEDs). Weighs 4.64 oz.

KEY	SKU	DESCRIPTION	MIN QTY
F	61050	Headlamp, 3 LED with Xenon Bulb, Black	each

(G) Mile High Foam® Backer Rod

Continuous lengths of flexible, round, closed cell polyethylene. Backer rod serves as a backing for elastomeric and other applied caulking sealants, controlling the depth and amount of sealant required. Black in color. All 8 sizes are shipped in an 18" x 18" x 30" box.

KEY	SKU	DESCRIPTION	ROLLS/BOX
G	BR025	Backer rod—1/4" x 6400'	1
	BR038	Backer rod—3/8" x 3600'	1
	BR050	Backer rod—1/2" x 2500'	1
	BR063	Backer rod—5/8" x 1550'	1
	BR075	Backer rod—3/4" x 1100'	1
	BR088	Backer rod—7/8" x 850'	1
	BR100	Backer rod—1" x 550'	1
	BR125	Backer rod—1-1/4" x 400'	1

(H) Barricade Caution Tape, 3" x 1000'

An economical disposable marking solution manufactured for exceptional durability and resistance to the elements.

KEY	SKU	DESCRIPTION	ROLLS/CASE
H	CAUTIONTAPE	2 Mil Barricade Tape—3" x 1000'	8



(A) Sill Sealer

Sill Seal is a 1/4" thick polyethylene flexible foam gasket strip. Sill Seal can help reduce air infiltration between the foundation and sill plate for enhanced energy savings as well as resistance to water and water vapor. Color may vary.

KEY	SKU	DESCRIPTION	MIN/QTY
A	SS3550	Sill Seal—3.5" x 50' —6 rolls per bag	bag
	SS5550	Sill Seal—5.5" x 50' —4 rolls per bag	bag
	SS7550	Sill Seal—7.5" x 50' —3 rolls per bag	bag

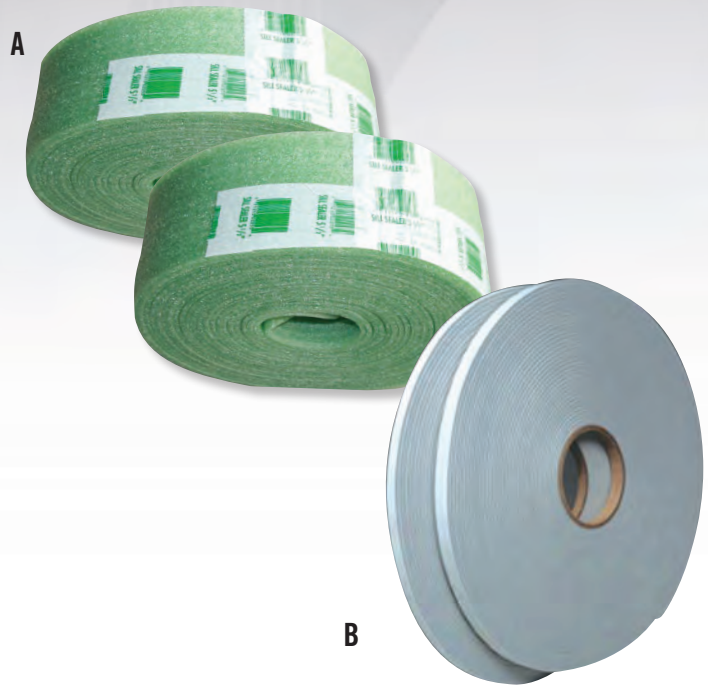

(B) Venture Vinyl Foam Sealant Tape

A specially formulated pressure sensitive adhesive system applied to a very flexible, closed cell vinyl foam. The vinyl foam tape is grey in color and has a density of 10 lb. per cubic foot.

KEY	SKU	DESCRIPTION	ROLLS/CASE
B	TVFS1714	Venture Vinyl Foam Sealant Tape 3/8" x 50'	32

(C-F) Gaskets

These foam outlet and switch gaskets are UL approved and made of closed-cell material. Use along with safety caps on all outside walls to prevent air infiltration.

KEY	SKU	DESCRIPTION	MIN QTY
C	OS200	Foam receptacle gasket	each
D	OS500	GFI foam outlet/switch gasket	each
E	OS300	Foam switch gasket	each
F	OS400	Plastic safety caps	each

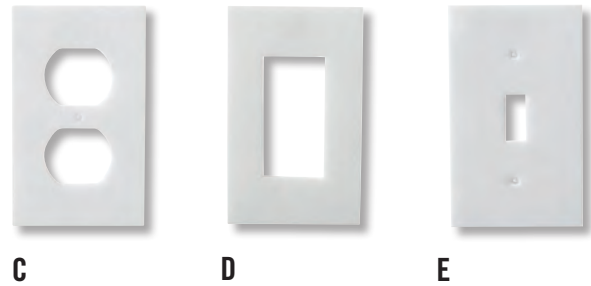

RECIPROCATING SAW BLADES

(G-J) Bosch Bi-Metal Reciprocating Saw Blades

Reciprocating saw blades have a bit-metal construction for maximum life and durability in heavy use. Choose appropriate model for wood, metal or plaster material.

KEY	SKU	DESCRIPTION	#TPI	MIN QTY
G	BRW66	Bi-metal reciprocating blade for wood w/nails—6" (5/pkg)	6	1 pkg
H	BRS624	Bi-metal reciprocating blade for sheet metal—6" (5/pkg)	24	1 pkg
I	BRPD66	Bi-metal reciprocating blade for plaster/drywall—6" (5/pkg)	6	1 pkg
J	BRW96	Bi-metal reciprocating blade for wood w/nails—9" (5/pkg)	6	1 pkg

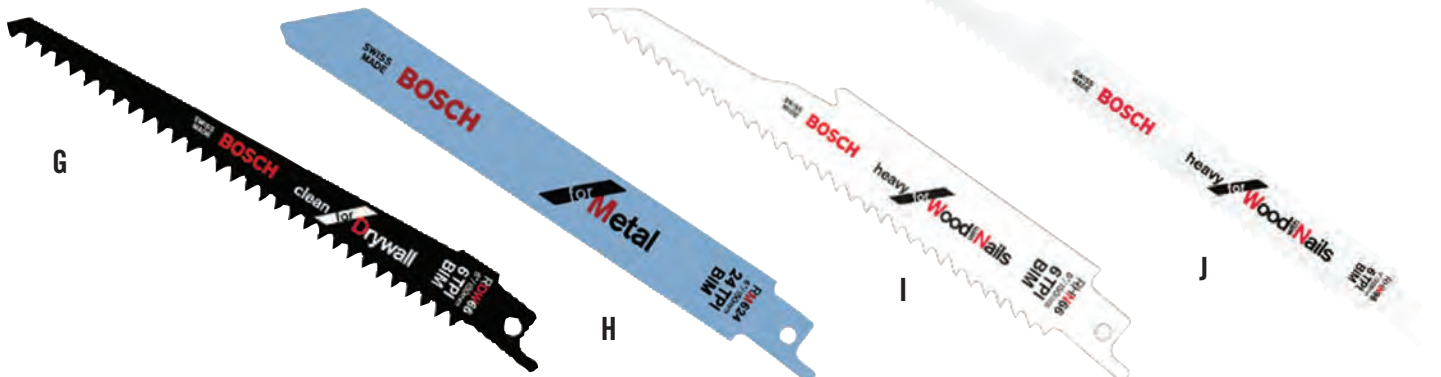



(A) The Attic Tent

The patented Attic Tent consists of a durable shell made of synthetic casting, designed to create an air transfer barrier between attic and living areas. Keeps blown insulation in the attic when the attic stair door is opened. Calculated to a 3.2 R-Value. The ½" thick micro-fiber urethane insulation, is proven to reduce air transfer by at least 71%.

- The Attic Tent materials have been calculated to a 3.2 R-Value
- Fits easily around an attic stair frame

KEY	SKU	DESCRIPTION	MIN QTY	QTY/CASE
A	AT1	22" x 54" x 7"	each	5
	AT2	25" x 54" x 7"	each	5
	AT3	22" x 54" x 13"	each	5
	AT4	25" x 54" x 13"	each	5
	AT5	30" x 60" x 13"	each	5
	AT6	32" x 81" x 5"	each	5

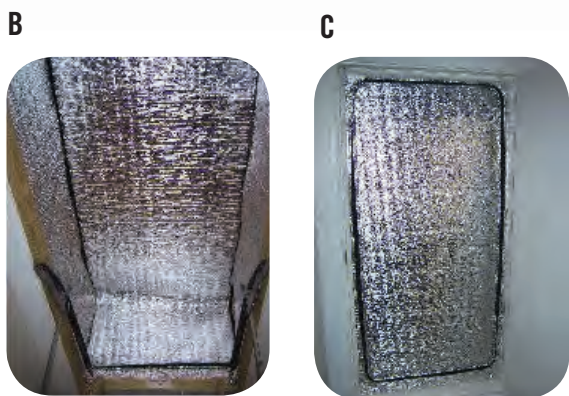

SEAL'N SHIELD™

Foil material reflects 97% of radiant heat. Units have fireproof zippers and kevlar™ heat resistant thread. Thermal blanket portion has a zero flame spread rating and a smoke development rating of 15.

(B) Pull Down Stair Cover

For horizontal installation—designed to seal pull-down stair openings. R-Value down 13, R-Value up 11.

KEY	SKU	DESCRIPTION	MIN QTY
B	ES5422	54" L x 22.5" W x 11" H	each
	ES5425	54" L x 25" W x 11" H	each
	ES542516	54" L x 25" W x 16" H	each

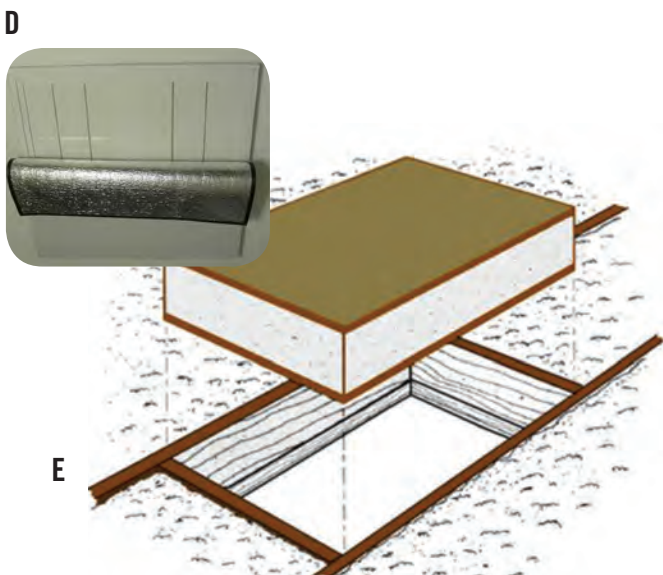

(C) Attic Door Cover

For vertical installation—designed to seal knee wall doors.

KEY	SKU	DESCRIPTION	MIN QTY
C	ES4824	48" x 24" - Horizontal R-Value 9.7	each

(D) Seal A Vent Fan Grill Cover

Seals and insulates a whole house fan shutter vent grill. Mounts direct to shutter vent grill by using a white magnetic air sealing system. Effective R-Value of 11.7 with 97% of radiant heat reflected.

KEY	SKU	DESCRIPTION	MIN QTY
D	ESSAV3648	36" x 48" Insulated Ventilation Grill Cover	each

(E) Insul-Door

The Insul-Door is a perfect replacement for old plywood attic doors. Packing carton reverses to make a dam around the hole to keep the insulation in the attic. Shipped 24" x 32" x 8" thick, cut to size. R30 R-Value.

KEY	SKU	DESCRIPTION	MIN QTY
E	IDR30	24" W x 32" L x 8" thick —R30	case

(F-G) C-Series Cornice Intake Vents

Aluminum with built-in perma-coated insect screens.

KEY	SKU	DESCRIPTION	MIN/CTN	CTNS/PALLET
	C416W	16" x 4" White	12	40
F	C416BR	16" x 4" Brown (Pictured)	12	40
G	C816W	16" x 8" White (Pictured)	12	24
	C816BR	16" x 8" Brown	12	24

(A) Whirlybird® Turbine Vents – 12"

Turbine design features permanently lubricated upper and lower ball bearings that ensure long life and no maintenance. Rigid spider-type construction—riveted at every connection and tested to withstand winds of 110 M.P.H.

- 21 air-foil curved vanes with rolled edges to deflect water
- 100% rust-free all-aluminum construction
- Dimensions: Overall 20" x 20" x 17 ¼"; Hole size 12"

KEY	SKU	DESCRIPTION	MIN/CTN	CTNS/PALLET
A	BIB12B	Black	1	20
	BIB12BR	Brown	1	20
	BIB12WB	Weathered Bronze (Pictured)	1	20



The "Original" Slant Back Roof Vent

Lomanco® Static Roof Vents are exhaust vents by design. Each vent's unique design offers maximum weather protection. Featuring bird-proof design, weather tight sealed collar, and high profile and rolled flange on the vent stack for superior weather protection and circulation.

(B) 750 Galvanized Steel Series

Dimensions: Overall 16" x 20-5/16" x 5". Hole Size 8"

KEY	SKU	DESCRIPTION	MIN/CTN	CTNS/PALLET
B	750GSB	Galvanized Steel – Black (Pictured)	6	28
	750GSBR	Galvanized Steel - Brown	6	28
	750GSWB	Galvanized Steel - Weathered Bronze	6	28

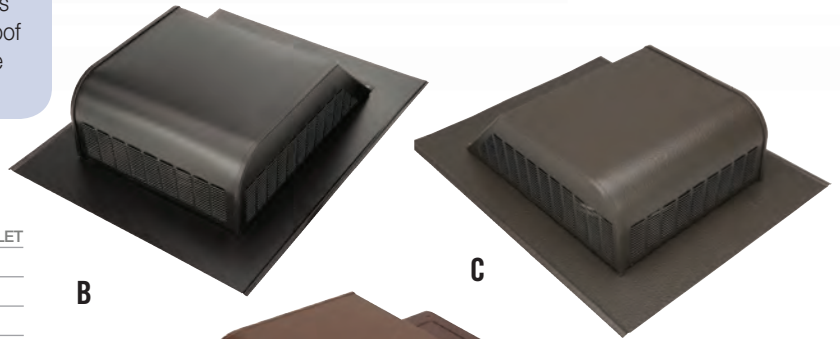

(C) 750 Aluminum Series

Dimensions: Overall 16" x 20-5/16" x 5". Hole Size 8"

KEY	SKU	DESCRIPTION	MIN/CTN	CTNS/PALLET
C	750SB	Black	6	28
	750SBR	Brown	6	28
	750SWB	Weathered Bronze (Pictured)	6	28
	750SFG	Forest Green	6	28

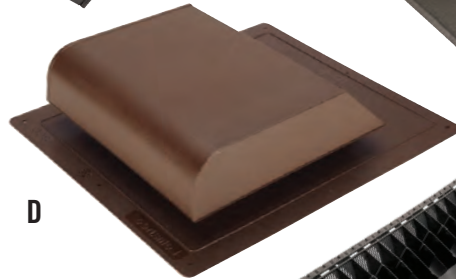

(D) 800 ABS Plastic Series

Dimensions: Overall 16-1/2" x 20-5/16" x 4-3/4". Opening 8-1/2" x 10-1/4"

KEY	SKU	DESCRIPTION	MIN/CTN	CTNS/PALLET
D	865B	Black	6	24
	865BR	Brown (Pictured)	6	24
	865WB	Weathered Bronze	6	24

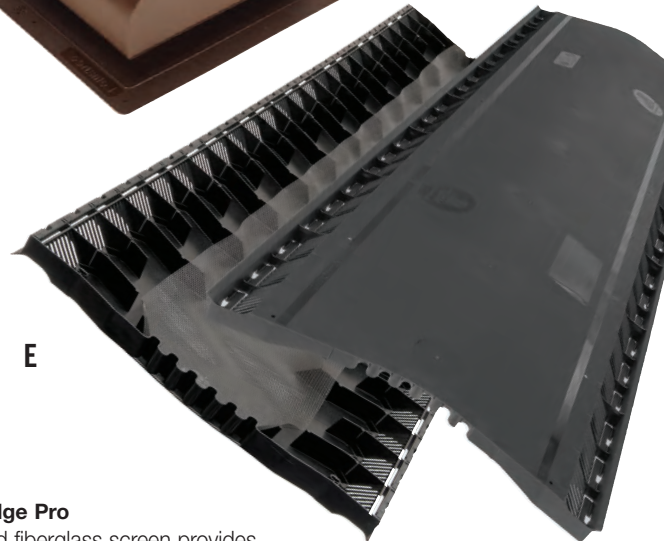

(E) OmniRidge Pro

Sonic welded fiberglass screen provides enhanced weather protection. Advanced low profile design.

KEY	SKU	DESCRIPTION	MIN/CTN	CTNS/PALLET
E	PR04S	Pro4 — 4' shingle over vent w/netting	10	30

(F) Lo-OmniRoll®

The rollable, gunnable and functional ridge vent. Pneumatic nail gun or hammer installed. Two coils of 1-3/4" nails provided. Compact 30' roll easy to handle.

KEY	SKU	DESCRIPTION	MIN/CTN	CTNS/PALLET
F	LOR-30	Lo-OmniRoll 30' rolled shingle over vent	each	24



RECESSED LIGHT COVERS

(A) Insul-Shield

Your best protection against fire caused by heat build-up from insulating over or too close to non-IC-rated recessed lights, or other heat-producing fixtures. 14" x 24' roll makes about six to eight shields.

- Lightweight aluminum material.
- Safe for use with cellulose, fiberglass and rockwool insulation.

KEY	SKU	DESCRIPTION	MIN QTY	ROLLS/CARTON
A	IS1424	14" H x 24' L roll	1 roll	12

(B) Poly Recessed Light Cover

A great way to get an airtight seal over IC-rated recessed lights for new or retrofit applications. Not to be used on non-IC-rated lights.

- Made of an extra heavy grade of polyethylene film
- Pre-formed to fit over most light cans

KEY	SKU	DESCRIPTION	MIN QTY
B	SVB18	12"W x 18"H x 8"D	each

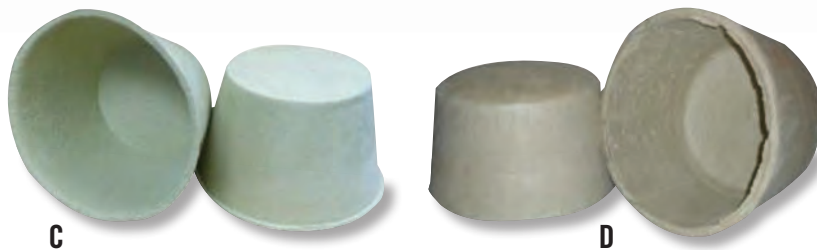

C

D



E



F



G

H



I

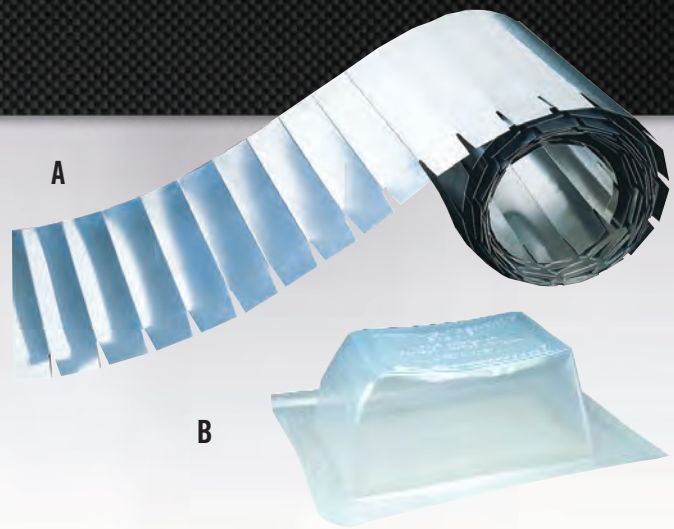

A

B

(C-D) TENMAT Recessed Light Covers

Made out of a fire-resistant mineral wool that exhibits excellent thermal insulating properties. Compatible with sprayed foam insulation, low density foam, blown-in insulation and lay-in insulation. Can be used with IC Rated and non-IC Rated lights.

KEY	SKU	DESCRIPTION	MIN QTY
C	FF130E	15"W x 14"H	20/case
D	FF135	10-3/4"W x 16-1/2"H	12/case

(E-F) The Insul-Lite® Pro Plus Recessed Light Cover

Fire retardant cover designed to allow the installer to insulate safely and effectively around recessed lights. When installed, the Insul-Lite® allows insulation to be placed as close to the light or heat producing fixture as possible without the risk of fire. Use vented Insul-Lite® covers for non-IC Rated lights and solid covers for IC Rated lights.

KEY	SKU	DESCRIPTION	MIN QTY
E	IL10	Vented—10" x 10" x 12", 25/Pack	pack
	IL12	Vented—12-1/2" x 12-1/2" x 14", 25/Pack	pack
F	IL10S	10" x 10" x 12", 25/Pack	pack
	IL12S	12-1/2" x 12-1/2" x 14", 25/Pack	pack

(G-H) CanCoverIt Recessed Light Cover

The first practical, safe, cost effective, efficient solution for insulating can light fixtures providing complete residential solutions for both contractors and DIYers. The Universal Series of CanCoverIt manages air flow by providing the installer with the option of installing the cover in an air tight configuration, or in a configuration which allows some heated air to escape. Covers must be vented to be used with Non-IC Rated lights. The low profile model can only be used with IC Rated lights.

- Internal Heat Resistance: 475-700° F
- Primary material is FSK-Faced Fiber Glass
- External Fire Resistance Rating: UL723/ASTM E84-0 Smoke/5 Flame Spread

KEY	SKU	DESCRIPTION	MIN QTY
G	CANCOVERU	Universal cover—14" x 14" x 22"H	each
H	CANCOVERLP	Low Profile cover—14" x 14" x 12"H	each

(I) Superior F2 Facing

Superior F-2 radiant insulation is composed of aluminum foil laminated with flame retardant adhesive to both sides of 100 lb Kraft paper.

KEY	SKU	DESCRIPTION	MIN QTY
I	CANLIGHTF2255	100 lb Kraft paper roll 25-1/2" x 118'	50 rolls

THE INSTALLER

(A) The Installer

The batt installer screws onto the tip of the BI7710 and BI6512 extension poles, allowing for easy installation of pressure-fit batt insulation and wire batt supports in both overhead and wall installations.

KEY	SKU	DESCRIPTION	MIN QTY
A	BI102	The Installer, Batt Installation Tool	pair



A

EXTENSIONS

(B) Smart-Lok® Extension Poles

Quickly change roller frames or other tools with the push of a button for Quick-on/Quick-off action.

- Heavy-duty composite fiberglass handle
- Patented locking device

KEY	SKU	DESCRIPTION	MIN QTY
B	BI7710	Smart-Lok extension pole—5' to 9'	each



B

(C) Twist Lock® Extension Poles

Combination smooth composite fiberglass handle and aluminum tube for balance. Die cast metal 3/4" (2 cm) threaded end and heavy duty chuck and collet locking device.

KEY	SKU	DESCRIPTION	MIN QTY
C	BI6512	Twist Lock extension pole—6' to 12'	each



C

BATT SUPPORTS



D

(D) Wire Batt Supports

(also known as tiger teeth, wire stays and lightning rods)

Fastest, most economical method of installing roll and batt type insulation. Made of high tensile wire with angle cut to dig into wood. When installing batt supports space them 12" to 16" apart.

- Spring wire supports install with a twist of the wrist
- Holds permanently in floors, walls and ceilings

KEY	SKU	DESCRIPTION	QTY/BOX
D	BS120	Wire batt supports—12"	500
	BS160	Wire batt supports—16"	500
	BS170	Wire batt supports—17"	500
	BS180	Wire batt supports—18"	500
	BS190	Wire batt supports—19"	500
	BS200	Wire batt supports—20"	500
	BS230	Wire batt supports—23"	500
	BS240	Wire batt supports—24"	500
	BS250	Wire batt supports—25"	500
	BS260	Wire batt supports—26"	500



INSULATION ANCHORS

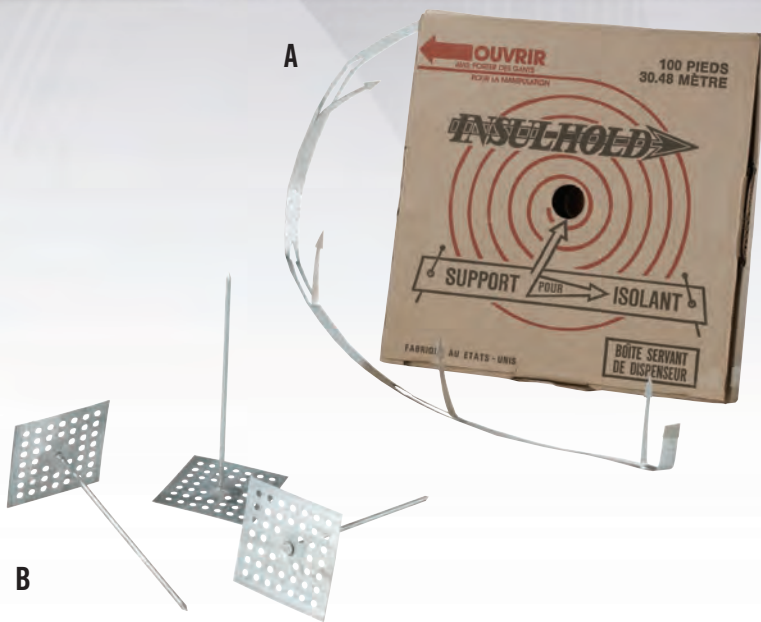

(A) Insul-Hold

Unique design simplifies installation. Insulation is impaled on the 2-1/2" arrow prongs which are on 8" centers. Use with either 16" or 24" OC. Product is .025 to .028 thick and 1" wide. It is cold rolled and hot dipped galvanized with a dry finish.

- Holds rigid or batt insulation
- Doubles as reinforcement strapping

KEY	SKU	DESCRIPTION	MIN QTY
A	IH660	Insul-Hold—100' roll	1 Roll

(B) Standard Insulation Anchors

Glued in place and used to support rigid board and batt type insulation on wall and ceiling applications. The anchors incorporate a 12-gauge spindle (nail) and a 2" x 2" square perforated base made of low carbon steel, galvanized coating.

KEY	SKU	DESCRIPTION	QTY/CARTON
B	IS016	Anchors—1-5/8"	1000
	IS020	Anchors—2"	1000
	IS025	Anchors—2-1/2"	1000
	IS0351	Anchors—3-1/2" Standard	500
	IS045	Anchors—4-1/2"	500
	IS055	Anchors—5-1/2"	500
	IS065	Anchors—6-1/2"	500
	IS0851	Anchors—8-1/2"	250
	IS0951	Anchors—9-1/2"	250
	IS1051	Anchors—10-1/2"	250
	IS1151	Anchors—11-1/2"	250
	IS1251	Anchors—12-1/2"	250
	IS1451	Anchors—14-1/2"	250



(C) Anchor Adhesive

High strength, heavy bodied, neoprene rubber adhesive, specifically formulated for adhering insulation anchors. Coverage is one gallon of adhesive for every 500-1000 hangers.

KEY	SKU	DESCRIPTION	MIN QTY
C	IS101	Anchor adhesive—gallon	each

(D) Boss 180 Multi-Seal Insulation Anchor Adhesive

Use for rigid board & fibrous, semi-rigid board insulation masonry walls, ducts & metal buildings. Adheres to paint & galvanized surfaces and can be used with nylon & metal-based pins. Provides an immediate grab and high bond strength, making insulation ready to be hung the next day. Low odor, VOC Compliant. Each tube can cover approximately 200 pins. California compliant.

KEY	SKU	DESCRIPTION	TUBES/CASE	CASES/PALLET
D	CLK180	Boss 180—10.1 oz tube—white	12	108

(E-G) Self-Locking Washers

Round and square washers are mild steel, galvanized coating. The dome caps are aluminum material with a stainless steel insert.

KEY	SKU	DESCRIPTION	QTY/CARTON
E	IS014	Washers, round self-locking—1-1/2"	1000
F	IS015	Washers, square self-locking—1-1/2"	1000
G	IS013	Washers, dome caps—7/8" dia	1000
	IS013W	Washers, dome caps—7/8" dia White	1000

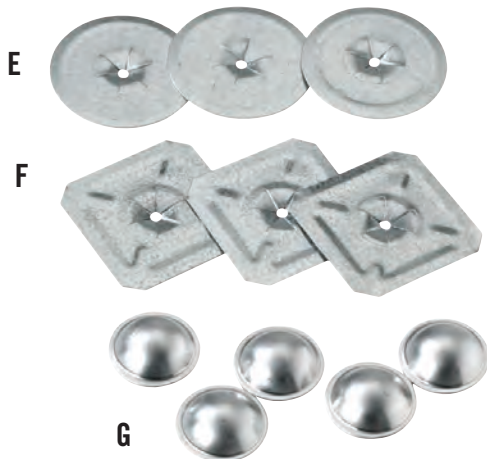

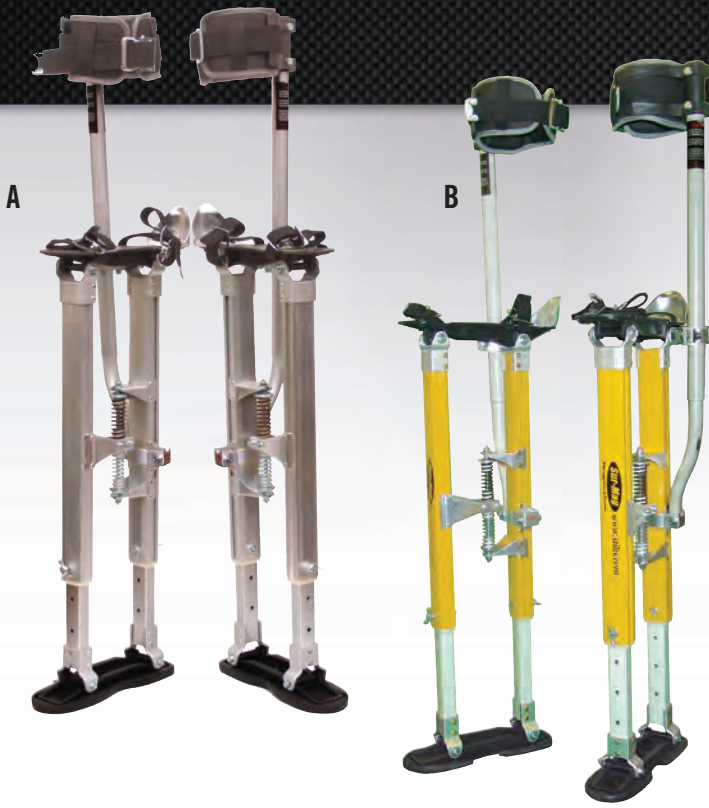

(A-B) Sur-Pro Stilts/Single-Sided

Top-of-the-line adjustable height stilts. Spring tension (individually adjustable for natural leg movement) gives exactly the right “feel.” Telescoping legs slide smoothly for quick and easy adjustment without tools. Strap and shoe adapters included. Available in aluminum or magnesium—magnesium components offer enhanced durability and save 2 lbs. in weight per pair of stilts.

KEY	SKU	DESCRIPTION	MIN QTY
A	SS1523AP	Sur-Stilts—15" - 23"	1 pair
	SS1830AP	Sur-Stilts—18" - 30"	1 pair
	SS2440AP	Sur-Stilts—24" - 40"	1 pair
B	SS1523MP	Sur-Stilts magnesium—15" - 23"	1 pair
	SS1830MP	Sur-Stilts magnesium—18" - 30"	1 pair
	SS2440MP	Sur-Stilts magnesium—24" - 40"	1 pair

Refer to schematics on page 67.



(C-D) Sur-Pro Stilts/Double-Sided

The next generation of stilts! Double-sided Sur-Stilts surpass the capabilities of traditional stilts by providing:

- Better balance and safety
- Less fatigue
- More productivity

Available in aluminum or magnesium—magnesium components offer enhanced durability and save 2 lbs in weight per pair of stilts.

KEY	SKU	DESCRIPTION	MIN QTY
C	S21830AP	Double-sided Sur-Stilts—18" - 30"	1 pair
	S22440AP	Double-sided Sur-Stilts—24" - 40"	1 pair
D	S21523MP	Double-sided Sur-Stilts, magnesium—15" - 23"	1 pair
	S21830MP	Double-sided Sur-Stilts, magnesium—18" - 30"	1 pair
	S22440MP	Double-sided Sur-Stilts, magnesium—24" - 40"	1 pair



Sur-Pro Stilts Replacement Kits

SKU	DESCRIPTION	MIN QTY
SS1001	Sur-Pro Hardware Kit (SS & S2)	each
SS1002BK	Sur-Pro Strap Kit (SS only)	each
SS1002V	Sur-Pro Velcro Kit (SS only)	each
SS1003R	Sur-Pro Rubber Floor Plate w/sole (SS & S2)	each
SS1004	Sur-Pro Spring Kit (SS & S2)	each
SS1005P	Sur-Pro Plastic Leg Band Kit (new SS)	each
SS1005PF	Sur-Pro Wrap-around L.B.K. (new SS)	each
SS1006	Sur-Pro Clamp Kit (SS only)	each
SS1007	Sur-Pro Plastic Sleeve Kit (SS & S2)	each
SS1008	Sur-Pro Wing Bolt Kit (SS & S2)	each
SS1009	Sur-Pro Heel Bracket Kit (SS & S2)	each
SS1010R	Sur-Pro Right Leg Band Kit (S2 only)	each
SS1010L	Sur-Pro Strap Kit (S2 only)	each
SS1011	Sur-Pro Strap Kit (S2 only)	each



Refer to schematics on page 67.

LAMTEC®

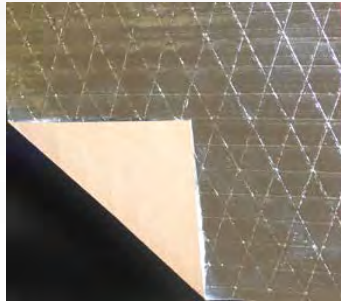
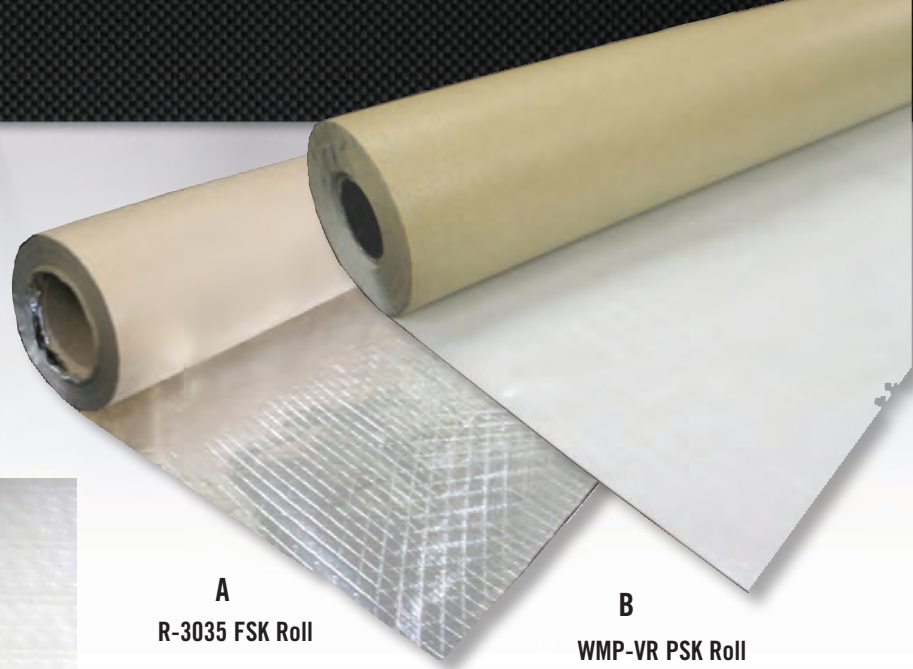

R-3035 FSK Folded

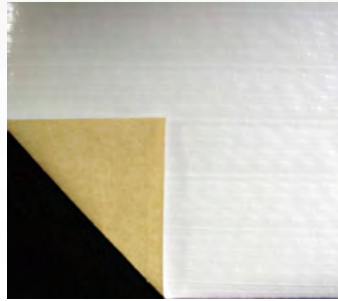

WMP - VR PSK Folded

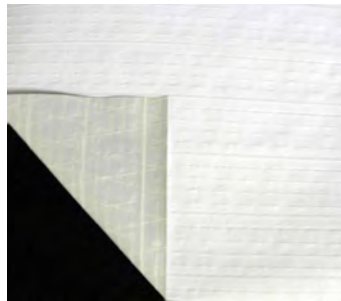

WMP-10 PSK Folded



30-J ASJ Folded

(A) FSK Facing R-3035

Lamtec R-3035 FSK (Foil-Scrim-Kraft) product is most commonly used as a facing for duct wrap insulation, but has many other insulation applications where a general use vapor retarder is needed. It is also a good choice for radiant barrier applications because of its extremely low emissivity. Permeance Test Method ASTM E 96, Procedure A - 0.02 perms.

KEY	SKU	DESCRIPTION	ROLLS/PALLET
A	R3035FSK50300	R-3035 FSK 50" x 300' roll	49
	R3035FSK50600	R-3035 FSK 50" x 600' roll	36
	R3035FSK54300	R-3035 FSK 54" x 300' roll	49
	R3035FSK54600	R-3035 FSK 54" x 600' roll	36

(B) PSK Facing WMP-VR

Lamtec WMP-VR is a PSK (White polypropylene film, fiberglass & polyester scrim, 11# natural kraft) vapor retarder, or facing, primarily used for metal or pre-engineered buildings. It is a very cost effective metal building facing that has excellent installed appearance. The white film side is installed toward the interior of the building. Permeance Test Method ASTM E 96, Procedure A - 0.09 perms.

KEY	SKU	DESCRIPTION	ROLLS/PALLET
B	WMPVR54300	WMP-VR PSK 54" x 300' roll	49
	WMPVR54600	WMP-VR PSK 54" x 600' roll	36
	WMPVR54600P	WMP-VR PSK 54" x 600' perforated roll	36
	WMPVR54600B	WMP-VR PSK 54" x 600' roll (BLACK)	39
	WMPVR66600B	WMP-VR PSK 66" x 600' roll (BLACK)	28

A
R-3035 FSK Roll

B
WMP-VR PSK Roll

(C) PSK Facing WMP-10

Lamtec WMP-10 is a PSK (White polypropylene film, metallization, fiberglass and polyester scrim, 14# white kraft) used in applications as a vapor retarder or facing. It is a cost effective metal building facing that has excellent installed appearance. The white film side is installed toward the interior of the building. Permeance Test Method ASTM E 96, Procedure A - 0.02 perms.

KEY	SKU	DESCRIPTION	ROLLS/PALLET
C	WMP10255300	WMP-10 PSK 25.5" x 300' roll	48
	WMP1033300	WMP-10 PSK 33" x 300' roll	48
	WMP1054300	WMP-10 PSK 54" x 300' roll	36
	WMP1054300B	WMP-10 PSK 66" x 600' roll (BLACK)	36
	WMP1066300	WMP-10 PSK 66" x 300' roll	21

FSK Vapor Retarder Lamtec R3050 (not shown)

Lamtec R-3050 (Foil-Scrim-Kraft) product is used primarily as the facing or outer covering for fiberglass duct board, and in various insulation applications where a strong, abuse-resistant FSK vapor retarder or facing is needed. Permeance Test Method ASTM E 96, Procedure A - 0.02 perms.

KEY	SKU	DESCRIPTION	ROLLS/PALLET
	R3050FSK48300	VR R3050 FSK 48" x 300' roll	49

PSK Facing WMP-50 (not shown)

KEY	SKU	DESCRIPTION	ROLLS/PALLET
	WMP5054300	WMP-50 PSK 54" x 300' roll	49
	WMP5054300B	WMP-50 PSK 54" x 300' roll (BLACK)	49
	WMP5090300	WMP-50 VR PSKP 90" x 300' roll	28
	WMP5066300	WMP-50 VR PSKP 66" x 300' roll	28

(D) ASJ 30-J

Lamtec 30-J ASJ (All Service Jacket) is an aluminum foil-scrim/high intensity white kraft paper product used primarily for pipe and equipment (mechanical) insulation applications as a vapor retarder or facing. It is typically used with the white paper side exposed. Permeance Test Method ASTM E 96, Procedure A - 0.02 perm.

KEY	SKU	DESCRIPTION	ROLLS/PALLET
D	30JASJ48300	30J ASJ 48" x 300' roll	49

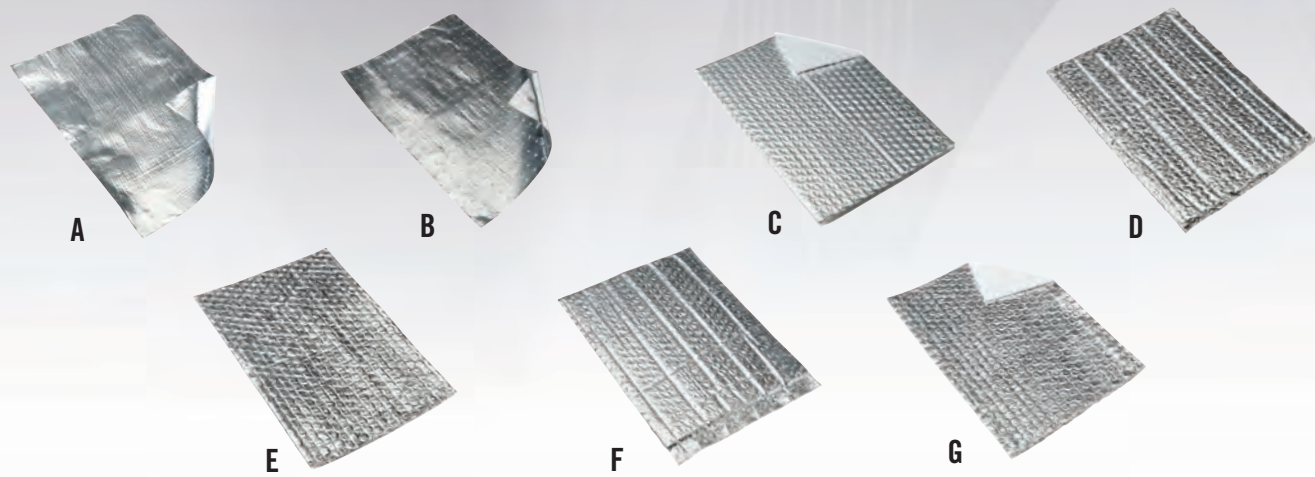

REFLECTIVE PRODUCTS TIPS:

R+Heatshield - RADIANT BARRIERS:

R+Heatshield is perfect over attic insulation (use perforated type), under rafters and over crawl spaces. It works as a complete insulation for metal and post-frame buildings, garages and garage doors. The solid type is ideal wherever a vapor and air infiltration barrier is needed. Perfectly safe to use, requiring no special breathing or handling precautions.

Tuff-Stuff - CONCRETE INSULATION:

High-strength insulating moisture barrier for use below heated concrete floors.

Astro-Shield - REFLECTIVE INSULATION:

Insulation material ideal for retrofit or new construction applications in commercial, industrial and agricultural pre-engineered metal and post-frame buildings. Its unique composite design consists of polyethylene air bubble pockets sandwiched between thin layers of reflective film. In many applications, Astro-Shield is more effective than 3" to 6" of conventional mass fiber insulation.

- Keeps buildings warmer in winter and cooler in summer
- Non-carcinogenic
- Lightweight material is thin, pliable and easy to install, and has little or no affect on building design loads
- Compact design works well in limited spaces—easy to ship/store
- Tough surfaces are wear and puncture resistant and can be pressure washed
- Water resistant, nonpermeable surfaces keep moisture out
- Solid surface wind barrier absolutely stops air infiltration, adding to the energy efficiency of any building
- Class1; Class A fire rating and low smoke spread

(A-B) R+Heatshield III, Solid or Perforated - RADIANT BARRIERS - Foil/HD Scrim/Foil

KEY	SKU	DESCRIPTION	MIN QTY
A	AFM1SIII	R+Heatshield III, solid—4' x 250'	1 roll
B	AFM5III	R+Heatshield III, perforated—4' x 125'	1 roll

(C) Tuff-Stuff - CONCRETE INSULATION - PET/Foil/Clear Bubble/Clear Bubble

KEY	SKU	DESCRIPTION	MIN QTY
C	AFPTS4125	Tuff Stuff—4' x 125'	1 roll
	AFPTS6125	Tuff Stuff—6' x 125'	1 roll

(D) Astro-Shield II - REFLECTIVE INSULATION - Foil/Bubble/Bubble/Foil

KEY	SKU	DESCRIPTION	MIN QTY
D	AFA9	Astro-Shield II—4' x 125'	1 roll
	AFA	Astro-Shield II—6' x 125'	1 roll
	AFAL	Astro-Shield II—16" x 125'	1 roll

(E) Astro-E - REFLECTIVE INSULATION - Foil/Bubble/Foil

KEY	SKU	DESCRIPTION	MIN QTY
E	AFE5	Astro-E—4' x 125'	1 roll
	AFE	Astro-E—6' x 125'	1 roll

(F) Astro-Tab / Astro-Peel & Seal - REFLECTIVE INSULATION - Foil/Bubble/Bubble/Foil

KEY	SKU	DESCRIPTION	MATERIAL	MIN QTY
F	AFA9PS	Astro-Peel & Seal—4' x 125'	3/4"release tape one side	1 roll
	AFAPS	Astro-Peel & Seal—6' x 125'	3/4"release tape one side	1 roll

(G) Astro-White - REFLECTIVE INSULATION

For ceilings in agricultural and commercial buildings including metal structures. For use as condensation barrier in heated or unheated commercial buildings, as radiant barrier in unheated commercial buildings, or as "white" facing for ceiling applications in commercial buildings. An excellent alternative to white vinyl-faced fiberglass batts.

KEY	SKU	DESCRIPTION	MATERIAL	MIN QTY
G	AFU1E5	Astro-White I—4' x 125'	Single Bubble	1 roll
	AFU1E	Astro-White I—6' x 125'	Single Bubble	1 roll
	AFUX4125	Astro-White II—4' x 125'	Double Bubble	1 roll
	AFUX6125	Astro-White II—6' x 125'	Double Bubble	1 roll

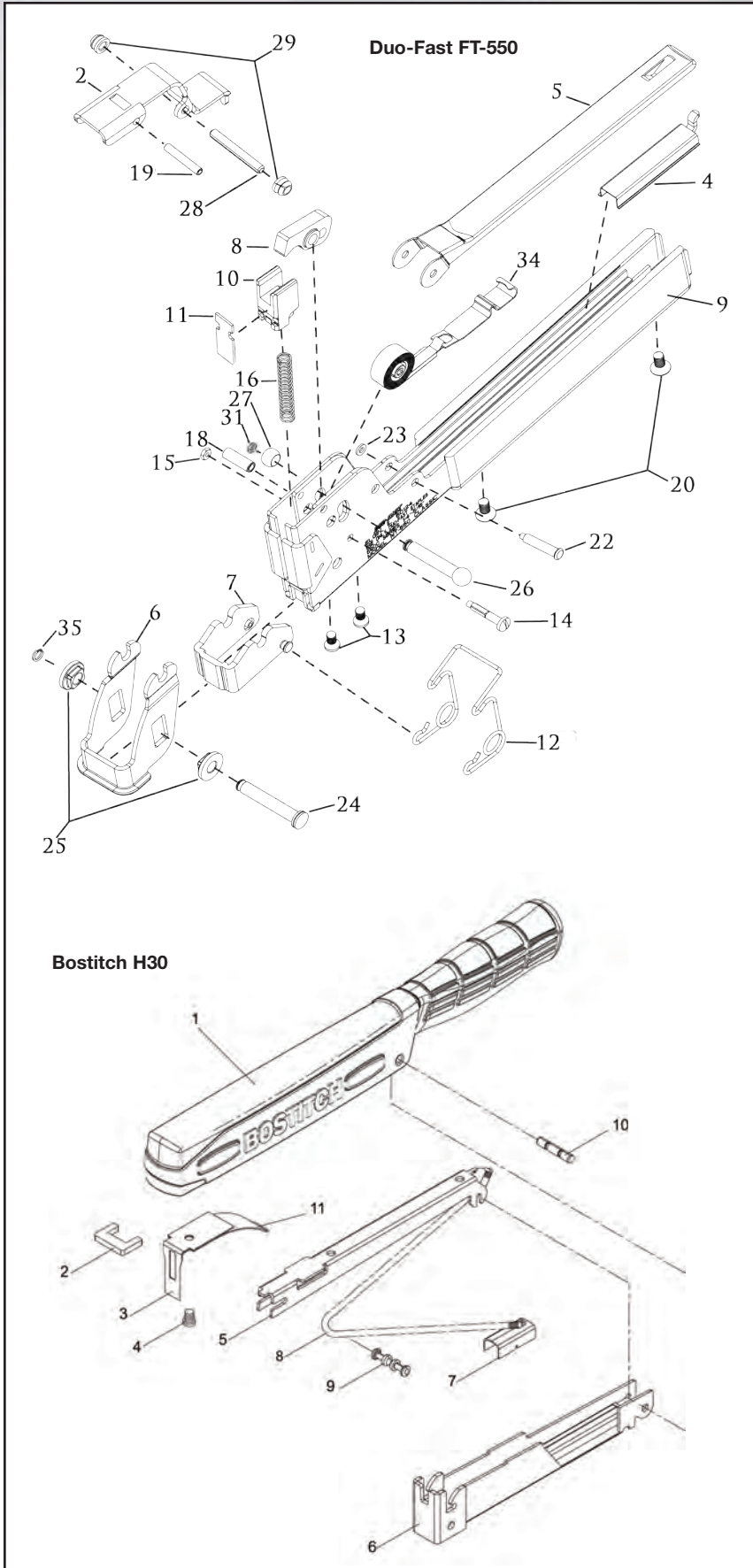

Duo-Fast FT-550 Classic – Parts Schematic

KEY	SKU	DESCRIPTION
2	HTP5507A	Hammer cap
3	HTP5509	Channel block
4	HTPHT335	Pusher bar
5	HTPHT336	Handle lid
6	HTPHT382	Lever assembly
7	HTPHT341	Front jaw
8	HTPHT3991	Plunger cam
9	HTPHT4102	Grip
10	HTP3151	Plunger body
11	HTP7053C	Driver blade
12	HTP7066	Spring
13	HTP3032	Screw
14	HTPHT1035	Feeder spring stud
15	HTP724	Nut
16	HTP727	Plunger spring
18	HTP3011	Cam pin
19	HTP730	Roll pin
20	HTPHT3031	Grip screw
22	HTP746	Handle lid stud
23	HTP747	Handle lid stud washer
24	HTPHT1012	Jaw pin
25	HTP3091	Trip lever bushing
26	HTPHT1011	Trip pin
27	HTPHT1071	Trip knob
28	HTP770A	Stud pin
29	HTPHT3092	Knob
	HTP794	Stud & bracket assembly
31	HTPOR0076N	Jaw pin O-ring
	HTPXH10848	Safety label
	HTPXH10856	Model label
34	HTPXK1150	Feeder spring complete
35	HTPHT3041	Split ring

Bostitch H30-6/H30-8 – Parts Schematic

KEY	SKU	DESCRIPTION
1	HTP177844	Frame-Grip-Pad assembly
2	HTP30603	Bumper
3	HTP30624	HTH306, driver
3	HTP30619	HTH308, driver
4	HTPUA3806	#10-24 x 3/8 Screw
5	HTP30605	Top guide
6	HTP30606	HTH306, magazine assembly
6	HTP30616	HTH308, magazine assembly
7	HTP177846	Pusher
8	HTP30608	Pusher spring
9	HTP30609	Roller
10	HTP30610	Pivot pin
11	HTP30615	Spring

Sur-Pro Stilts Parts Listing

PART NUMBER	DESCRIPTION
H101PF	Sur-Band micro-flex leg band
H104BK	Large leg strap
H105-15AP (MP)	1-1/8" diameter upper side pole for 1523 (Sur-Mag)
H105-18AP (MP)	1-1/8" diameter upper side pole for 1830 (Sur-Mag)
H105-24AP (MP)	1-1/8" diameter upper side pole for 2440 (Sur-Mag)
H106	#10 - 24-1/2" machine screw and nut
H107BK	Arch buckle and strap assembly
H108BK	Toe buckle and strap assembly
H109	Foot support plate
H110	Oversize heel bracket
H111	Pivot bearing
H112	1/4" flat washer
H113	1/4" x 20 lock nut
H114	1/4" x 20 hex nut
H115	Spring tension adjuster
H116	Upper heavy spring
H117	Strap mounting washers
H118	Nylon spring guide
H119	#8 x 3/8" self threading screw
H120	Upper/Lower spring divider
H122	1/4" x 7-7/8" threaded rod
H123-15P	1" diameter lower side pole for 1523
H123-18P	1" diameter lower side pole for 1830
H123-24P	1" diameter lower side pole for 2440
H124	1/4" - 20 x 1-1/2" cap screw and locknut
H126R	Rubber floor plate
H127	1/4" x 3" cap screw
H128	1/4" x 1-3/4" cap screw and square nut
H12930A	Side pole clamp
H131S	Side pole clamp adjustment bracket
H132	1/4"- 20 x 1-3/4" cap screw and locknut
H134	1/4" - 20 x 2" flat head machine screw and locknut
H135	Mounting screw with tapered washer for strap
H137	Sole mounting screw
H142	Wing bolt
H144	Lower standard spring
H145	Spring assembly
H147-15AP (MP)	Front leg assembly for 1523 (SII-Mag & Sur-Mag)
H147-18AP (MP)	Front leg assembly for 1830 (SII-Mag & Sur-Mag)
H147-24AP (MP)	Front leg assembly for 2440 (SII-Mag & Sur-Mag)
H148	Outer large nylon sleeve
H149	Inner small nylon sleeve
H150-15AP (MP)	Front leg assembly for 1523 (SII-Mag & Sur-Mag)
H150-18AP (MP)	Front leg assembly for 1830 (SII-Mag & Sur-Mag)
H150-24AP (MP)	Front leg assembly for 2440 (SII-Mag & Sur-Mag)
H151-15P (MP)	Inner rectangular adjustment tube for 1523
H151-18P (MP)	Inner rectangular adjustment tube for 1830
H151-24P (MP)	Inner rectangular adjustment tube for 2440
H164BK	Leg band strap
H165-15 M2P (A2P)	Side pole for 1523 (SII Mag)
H165-18 M2P (A2P)	Side pole for 1830 (SII Mag)
H165-24 M2P (A2P)	Side pole for 2440 (SII Mag)
H164BK	Leg band strap
H171	Side pole holder
H172	Strut tube cap plug
H173	Leg band laces (2 pcs)
H174	11 mm open end wrench
SS1010 (L,R)	SII leg band (Left, Right)

Sur-Pro Stilts/Parts Schematics

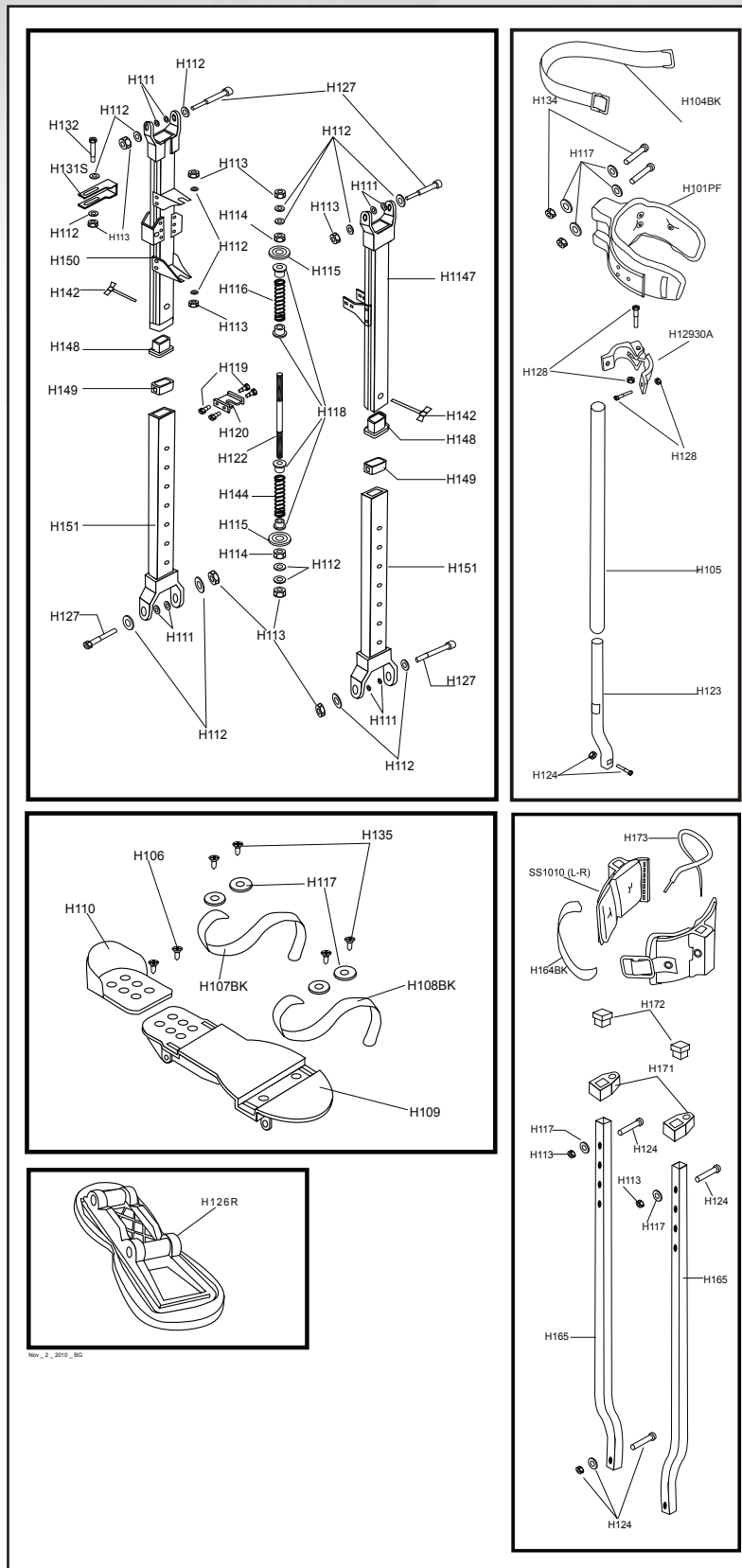

For a complete breakdown and parts list, please call or email us with your request.

3M Half-Face Respirator, 6000 Series

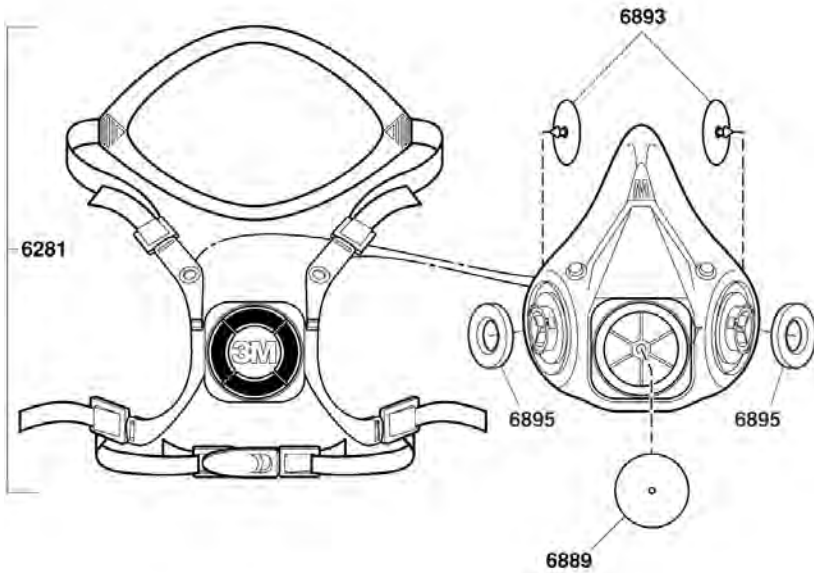

3M Half-Face Respirator, 6000 Series

PART NUMBER	DESCRIPTION
6281	Head Harness Assembly
6893	Inhalation Valve
6895	Inhalation Port Gasket
6889	Exhalation Valve

3M Full-Face Respirator, 6000 Series

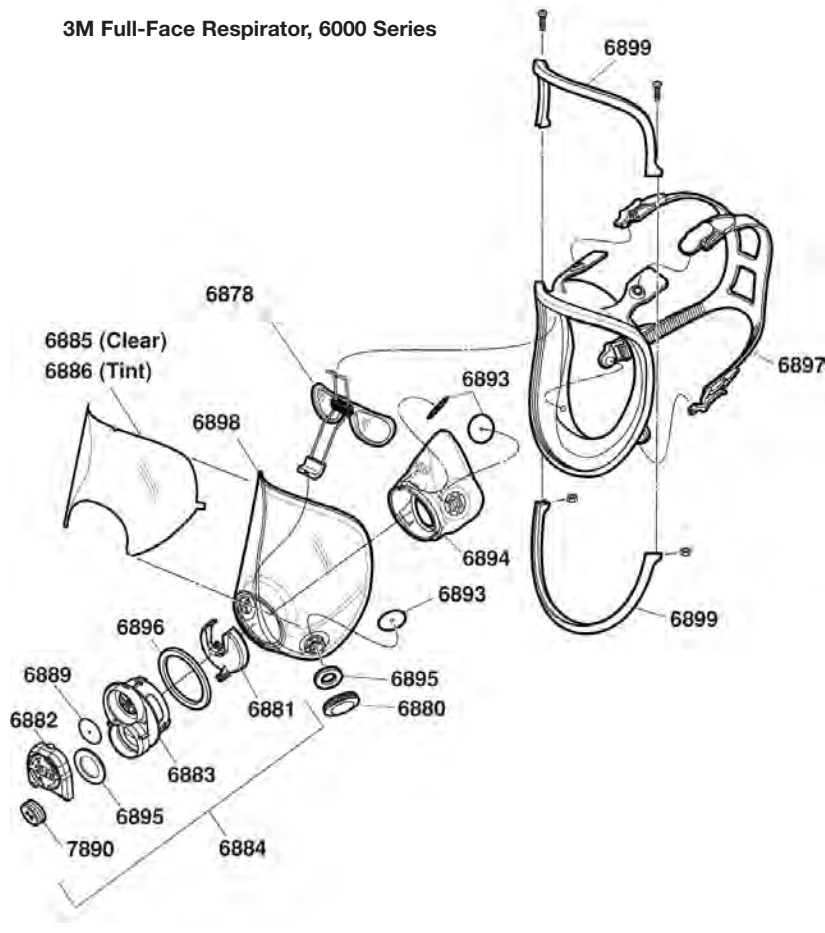

3M Full-Face Respirator, 6000 Series

PART NUMBER	DESCRIPTION
6878	Spectacle Kit
6880	Bayonet Cap
6881	Air Director
6882	Cover
6883	Port Base
6884	Center Port Adapter
6885 (Clear)	Faceshield Cover
6886 (Tint)	Tinted Lens Cover
6889	Exhalation Valve
6893	Inhalation Valve
6894	Nose Cup Assembly
6895	Inhalation Port Gasket
6895	Inhalation Gasket
6896	Center Adapter Gasket
6897	Head Harness
6898	Lens Assembly
6899	Frame Kit
7890	Plug

A·D·O[®]

More than just a distributor, ADO is the only prime manufacturer of attic ventilation channels offered to the insulation contractor. **Products You Need. Service We Deliver.**



DUROVENT[®]

The Number **ONE** selling vent in the industry!



DUROVENT[®]
BAFFLE

Offers full joist coverage with an adjustable heel. Its design allows for easy positioning and installation.



proVent[®]

Full joist coverage, this product is ideal for new construction or retrofit.

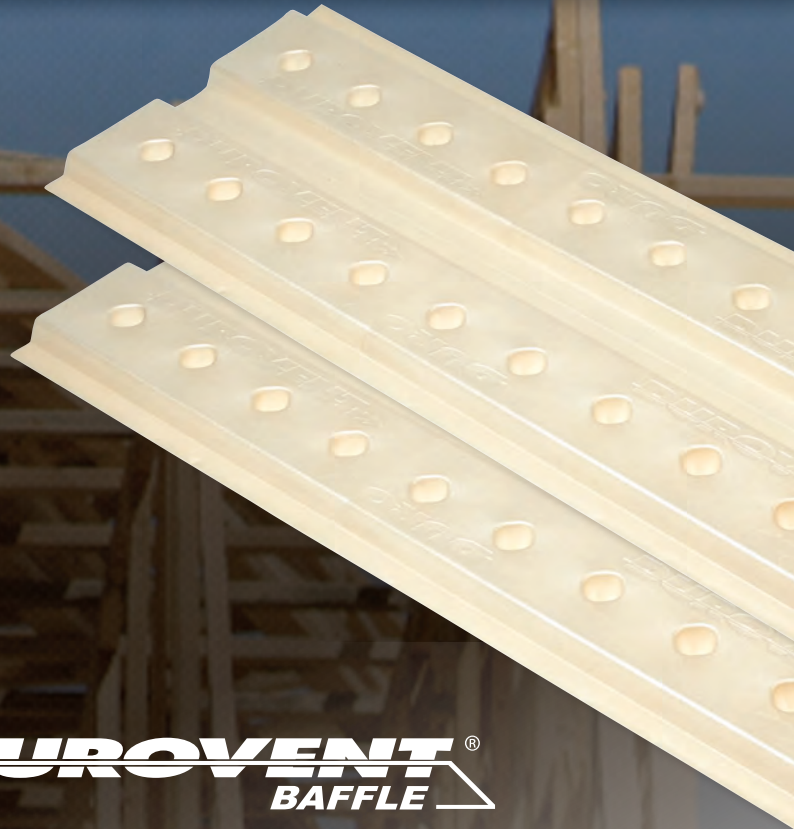

PRODUCTS YOU NEED.
SERVICE WE DELIVER.



A·D·O[®]

PRODUCTS YOU NEED. SERVICE WE DELIVER.

800-666-8191

sales@adoproducts.com

PROUD MEMBER OF
INSULATION CONTRACTORS
ICAA
ASSOCIATION OF AMERICA