



**Enhancing the
simple moments of
your everyday life.™**



Product Catalog

Stainless Steel
Composite Granite
Tectonite®
Accessories

www.FrankeUSA.com



Quality. Innovation. Value.

From Franke, the world's foremost innovator of intelligent kitchen systems, comes our most affordable line. FrankeUSA sinks and accessories are built for the way you actually live. We make products to keep your day running, to make your time more rewarding and to enhance the simple moments of your everyday life.

So, you need a **sink?**

Let's get started!

TABLE OF CONTENTS

What kind of sink is right for you?

4 **READY, SET, *SINK!***

What to consider when deciding which type of sink is best for you.

5 **SINKS, DECODED.**

Get familiar with all the sink features you didn't know existed!

Sinks

Styles, materials and functions fit for your lifestyle.

6 **STAINLESS STEEL**

8 **Topmounts**

- Single Bowls
- Double Bowls
- Triple Bowls

20 **Undermounts**

- Single Bowls
- Double Bowls

26 **Farmhouse**

- Single Bowls
- Double Bowls

27 **Sink Kits**

- Single Bowls
- Double Bowls

28 **COMPOSITE GRANITE**

Dual Mount

- Single Bowls
- Double Bowls

33 **TECTONITE®**

Dual Mount

- Double Bowls

Sink Accessories

Provide care and protection for your sink, while bringing improved functionality and organization to the entire kitchen!

34 **UNIVERSAL**

37 **CUSTOM FIT**

READY, SET, SINK!

Here's what to consider when deciding which type of sink is best for you:

1

LOCATION, LOCATION, LOCATION. The first thing to consider when choosing a sink is where it's going and how it will be used. Kitchen? Work space? Bar? Laundry room? Next, double-check your cabinet size to ensure your new sink will fit. This will help you land on the size and design best suited to your needs.

2

OUT WITH THE OLD AND IN WITH THE NEW.

If you're replacing your current sink, find a sink with the same dimensions so it fits securely into the cut-out of your countertop. If it is being installed in a new countertop, know which type of installation methods are compatible with your countertop material. For example, granite and other solid surface countertops will allow for sinks to be installed on top of (topmount) or below (undermount) its surface. On the other hand, standard laminate countertops will allow for sinks to be installed only as topmounts.

3

FACE IN THE HOLE! You should think about which fixtures make sense for your lifestyle to determine how many holes your sink will require. While stainless steel and Tectonite® sinks come with pre-drilled holes, granite sinks come with pre-drilled holes *and* "knock-outs." Think of knock-outs as small circular perforations. While completely invisible from the top, they can be easily identified from underneath and tapped out to create the hole count that is right for you. Sinks designed strictly for undermount installation don't have holes, so they will have to be drilled directly into your countertop or wall.

4

METAL OR CLASSIC ROCK? It's all about preference! Stainless steel and composite granite sinks are durable and stylish materials, so it all comes down to what you like best. Stainless steel is often a popular choice because it is hygienic, durable and coordinates well with other stainless steel appliances. If you're looking for a sink that will bring color into your kitchen while providing durability and unmatched germ-fighting properties, consider FrankeUSA composite granite sinks. Our exclusive Tectonite® sinks are another color solution that offer durability and style on a budget.

SINKS, DECODED.

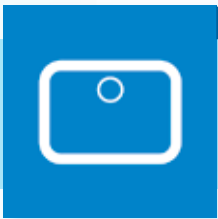

SINGLE BOWL

Available in many sizes, single bowl sinks can be used in a variety of places.

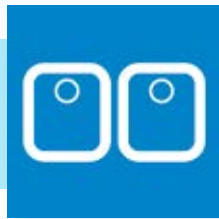

DOUBLE BOWL

You select your style: Standard (two equal-sized bowls) or Offset (asymmetrical bowls).



TRIPLE BOWL

If you often tackle several tasks at once, a sink with three bowls may be right for you. It's a great sidekick for any great multi-tasker.



FARMHOUSE

Often referred to as "apron-front," this sink style is designed with the front-facing portion exposed. Professional installation recommended.

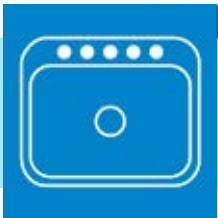

HOLE COUNT

Have a game plan when it comes to fixtures (like faucets, soap dispensers, etc.) and make sure your sink's hole count matches up.



TOPMOUNT

Often called a "drop in" sink, these are easiest to install and are often the way to go for the Do-It-Yourself-er.



UNDERMOUNT

Installed to the underside of the countertop, undermount sinks provide a seamless look. Professional installation recommended.



DUAL MOUNT

If you spot a dual mount sink, one thing you won't have to worry about is whether it will work with your countertop. It can be installed as a topmount or undermount!



SINK KITS

Don't want to spend time coordinating a sink with fixtures? No problem! Sink kits come with the sink, faucet and strainer(s).



DRAIN LOCATION

Traditionally, sinks come with center drains. Rear-positioned drains provide more usable space within the sink and beneath it.



GAUGE

When it comes to sink gauge, less is more. Quality sinks start at 22 gauge and as the number gets lower, the steel gets increasingly thicker!



DEPTH

Consider what tasks you will ask your sink to perform. Do you need a deeper sink for large pots or will a standard depth do the trick?



XL CAPACITY

Not all sinks are created equal. Some styles are designed to maximize bowl capacity (L x W), so everything from cookie sheets to skillet handles fit inside.



DRAIN LINES

These are shallow creases pressed into the bowl(s) of some stainless sinks to help channel water toward the drain. (They also add a pro look to your kitchen!)



ADA COMPLIANT

These sinks comply with the Standards for Accessible Design outlined by the Americans with Disabilities Act.



Stainless Steel
Timeless, versatile and low maintenance.

There is a good reason stainless steel is the leading material when it comes to sinks. Not only does it coordinate well with all kitchen styles, its non-porous surface makes it a hygienic place to prep food, bathe the baby, wash your dishes and do every job in between. Constructed of 100% stainless steel, they're strong and resilient, too.

- Heat resistant up to 2,750°F
- Ultra-Quiet™ sound-deadening
- Non-porous
- Limited lifetime warranty

Finish Guide:

Mirror = Highly Reflective

Silk = Soft Glow

Satin = Matte

To Clean:

For best results, opt for a mild liquid soap and a wet cloth to gently clean your sink. Avoid using harsh chemicals and rough brushes/sponges. After cleaning, rinse thoroughly and towel dry.



18-22 Gauge Stainless Steel



Heat Resistant



Sound Deadening



Durable Finish



Limited Lifetime Warranty

A2225/9

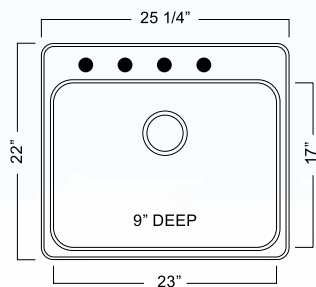

Gauge: 18
Finish: Silk Deck & Bowl
Minimum Cabinet Width: 27"

Accessorize with:

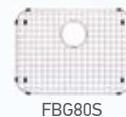

FBG80S



FMB1710

FSG804NB

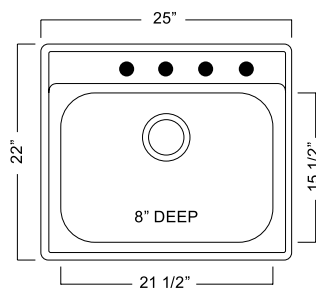

Gauge: 21
Finish: Silk Deck & Bowl
Minimum Cabinet Width: 27"

Accessorize with:



FGS75



FPSS604R (sleeve packaging)

FPSS604RB (box packaging)

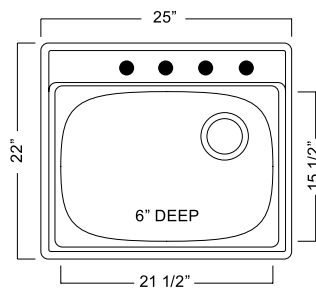

Gauge: 21
Finish: Satin Deck & Bowl
Minimum Cabinet Width: 30"

Accessorize with:



FCBU2216



ADA COMPLIANT

FSLG804BX

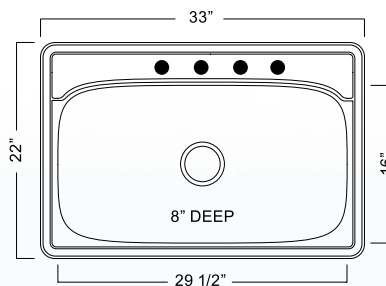

Gauge: 20
Finish: Silk Deck & Bowl
Minimum Cabinet Width: 36"

Accessorize with:



FBG2714

FSS603N (3 faucet holes, sleeve packaging)
FSS603NB (3 faucet holes, box packaging)

FSS604N (4 faucet holes, sleeve packaging)
FSS604NB (4 faucet holes, box packaging)

Gauge: 22
 Finish: Satin Deck & Bowl
 Minimum Cabinet Width: 27"

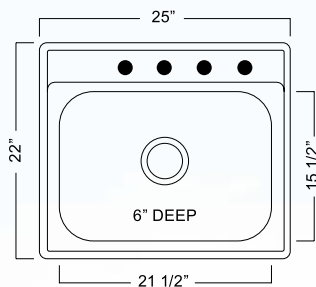

Accessorize with:



FGS50



FSS703N (3 faucet holes, sleeve packaging)
FSS703NB (3 faucet holes, box packaging)

FSS704N (4 faucet holes, sleeve packaging)
FSS704NB (4 faucet holes, box packaging)

Gauge: 21
 Finish: Satin Deck & Bowl
 Minimum Cabinet Width: 27"

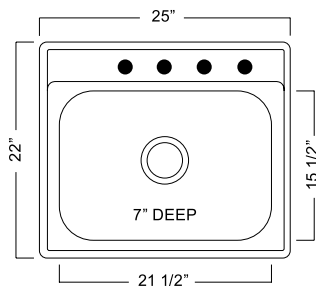

Accessorize with:



FGS50



FSS803N (3 faucet holes, sleeve packaging)
FSS803NB (3 faucet holes, box packaging)

FSS804N (4 faucet holes, sleeve packaging)
FSS804NB (4 faucet holes, box packaging)

Gauge: 20
 Finish: Satin Deck & Bowl
 Minimum Cabinet Width: 27"

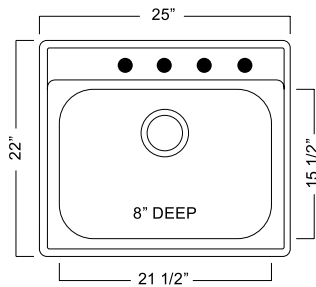

Accessorize with:



FGS75



SSK104NB

Gauge: 20
 Finish: Silk Deck & Bowl
 Minimum Cabinet Width: 27"

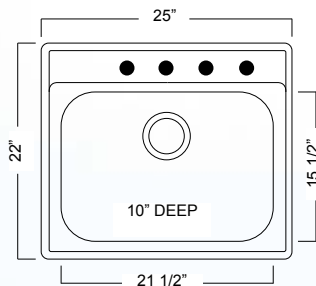

Accessorize with:



FGS75



SSK854NB

Gauge: 20
 Finish: Silk Deck & Bowl
 Minimum Cabinet Width: 27"

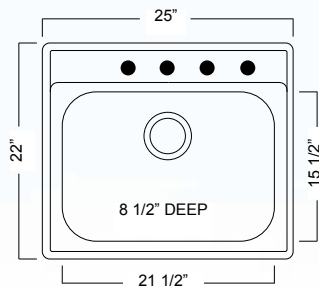

Accessorize with:



FGS75



SSKD104NB

Gauge: 20
 Finish: Silk Deck & Bowl
 Minimum Cabinet Width: 27"

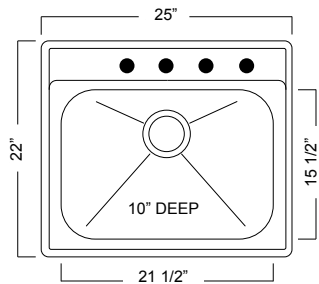

BMSK802 (2 faucet holes)

BMSK803 (3 faucet holes)

Gauge: 20
 Finish: Mirror Deck/Silk Bowl
 Minimum Cabinet Width: 21"

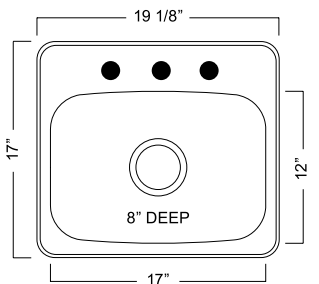

Accessorize with:



FBG65S



FMB1710



FBS602-35NB

Gauge: 22
 Finish: Silk Deck & Bowl
 Minimum Cabinet Width: 18"

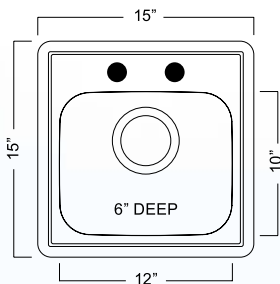

FBS602N (sleeve packaging)
FBS602NB (box packaging)

Gauge: 22
 Finish: Silk Deck & Bowl
 Minimum Cabinet Width: 18"

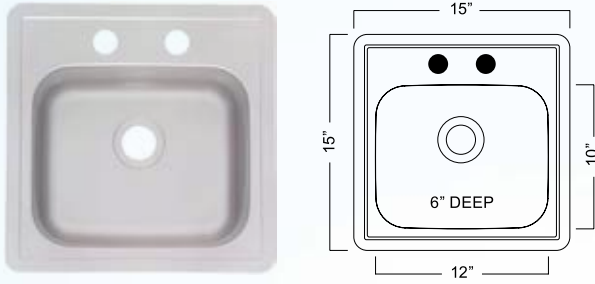

 **ACCEPTS 2" DRAIN FITTING**

FSG902-18BX

Gauge: 18
 Finish: Silk Deck & Bowl
 Minimum Cabinet Width: 27"

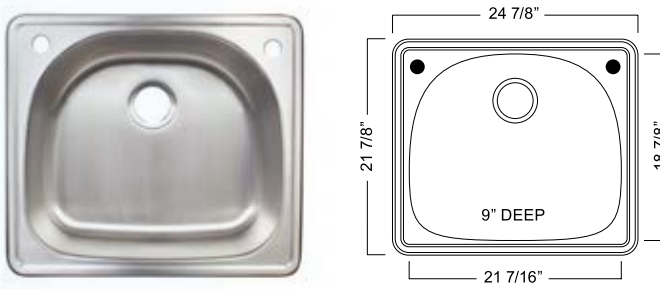

Accessorize with:

 FBG1821

SL103BX

Gauge: 20
 Finish: Silk Deck & Bowl
 Minimum Cabinet Width: 24"

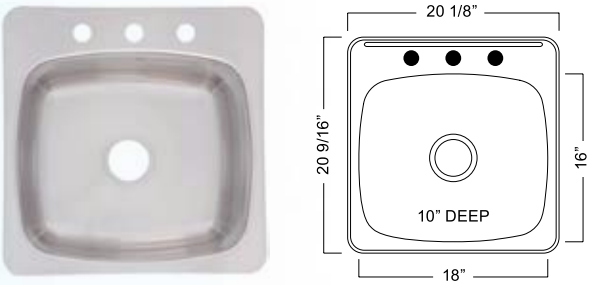

Accessorize with:

 FBG110S

  **DUAL MOUNT**

A1933/9

Gauge: 18
 Finish: Silk Deck & Bowls
 Minimum Cabinet Width: 36"

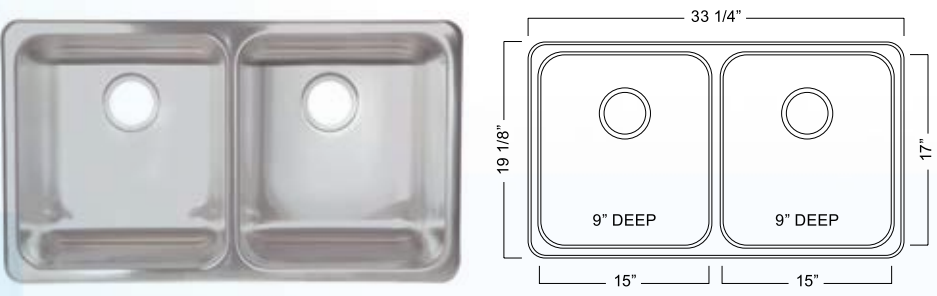

Accessorize with:

 FBGA1517S

DUAL MOUNT

A2233/9

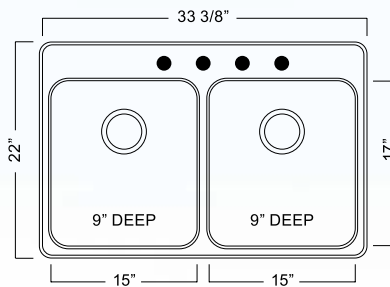

Gauge: 18
Finish: Silk Deck & Bowls
Minimum Cabinet Width: 36"

Accessorize with:

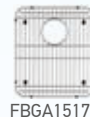

DFD901BX

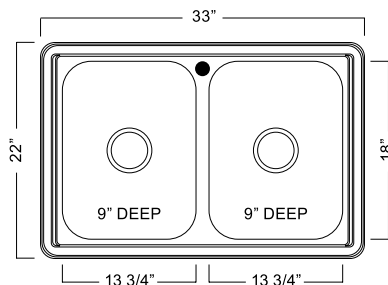

Gauge: 18
Finish: Satin Deck/Silk Bowls
Minimum Cabinet Width: 36"

Accessorize with:



DMSK954-18BX

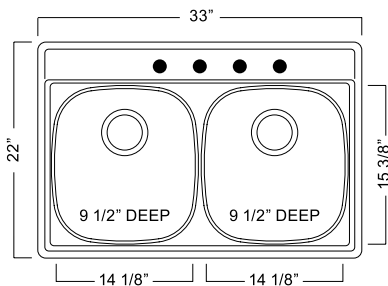

Gauge: 18
Finish: Mirror Deck/Silk Bowls
Minimum Cabinet Width: 36"

Accessorize with:



DSK851-18BX (1 faucet hole)
DSK854-18BX (4 faucet holes)

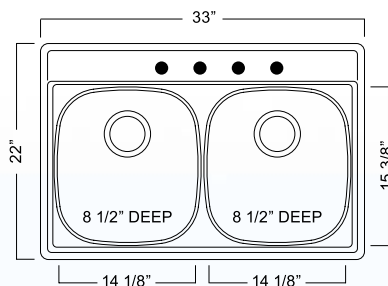

Gauge: 18
Finish: Satin Deck/Silk Bowls
Minimum Cabinet Width: 36"

Accessorize with:



DSK851BX (1 faucet hole)
DSK854BX (4 faucet holes)

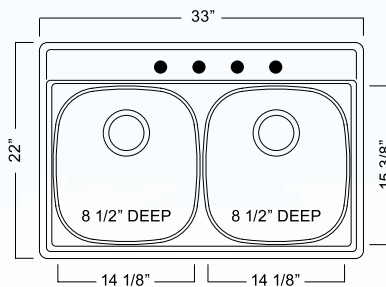

Gauge: 20
 Finish: Satin Deck/Silk Bowls
 Minimum Cabinet Width: 36"

Accessorize with:



FCBA1614



FDBA1614

DSK951-18BX (1 faucet hole)
DSK954-18BX (4 faucet holes)

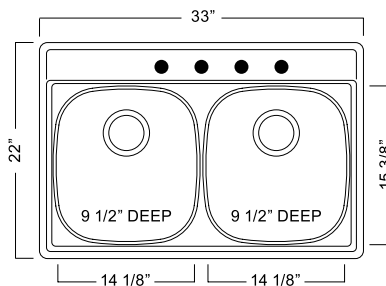

Gauge: 18
 Finish: Satin Deck/Silk Bowls
 Minimum Cabinet Width: 36"

Accessorize with:



FCBA1614



FDBA1614

DSK951BX (1 faucet hole)
DSK954BX (4 faucet holes)

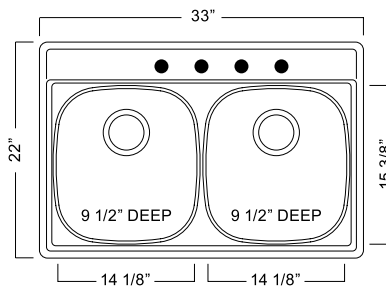

Gauge: 20
 Finish: Satin Deck/Silk Bowls
 Minimum Cabinet Width: 36"

Accessorize with:



FCBA1614



FDBA1614

DSKD954-18BX

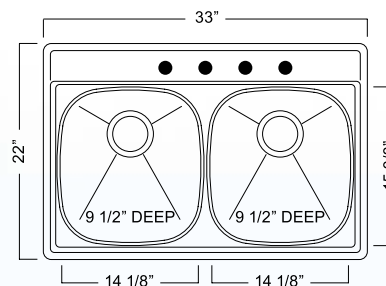

DRAIN LINES

Gauge: 18
 Finish: Satin Deck/Silk Bowls
 Minimum Cabinet Width: 36"

Accessorize with:



FCBA1614



FDBA1614

FBSG904BX

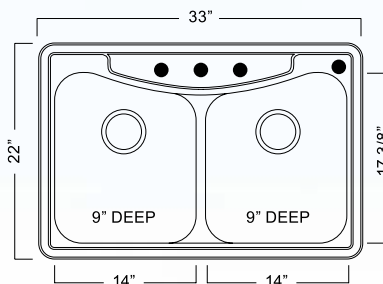

Gauge: 18
Finish: Silk Deck & Bowls
Minimum Cabinet Width: 36"

Accessorize with:



FBGL1613



FBGR1613



FDBA1614



FDBR10S

FDG804NB

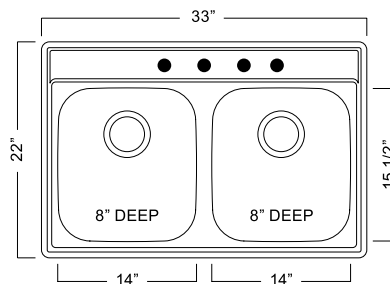

Gauge: 20
Finish: Satin Deck/Silk Bowls
Minimum Cabinet Width: 36"

Accessorize with:



FDBA1614



FGD75



FDMG804NB

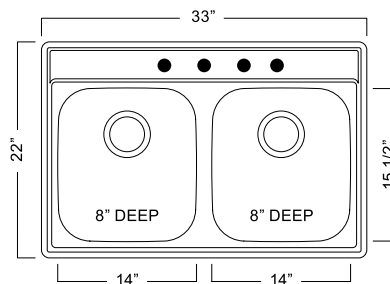

Gauge: 20
Finish: Mirror Deck/Silk Bowls
Minimum Cabinet Width: 36"

Accessorize with:



FDBA1614



FGD75



FDS603N (3 faucet holes, sleeve packaging)
FDS603NB (3 faucet holes, box packaging)

FDS604N (4 faucet holes, sleeve packaging)
FDS604NB (4 faucet holes, box packaging)

Gauge: 22
Finish: Satin Deck & Bowls
Minimum Cabinet Width: 36"

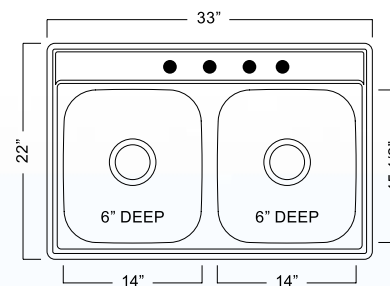

Accessorize with:



FDBA1614



FGD50



FDS654-20N (sleeve packaging)
FDS654-20NB (box packaging)

Gauge: 20
Finish: Satin Deck & Bowls
Minimum Cabinet Width: 36"

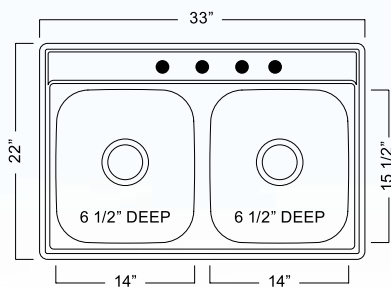

Accessorize with:

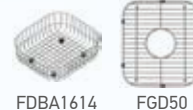

FDS654N (sleeve packaging)
FDS654NB (box packaging)

Gauge: 22
Finish: Satin Deck & Bowls
Minimum Cabinet Width: 36"

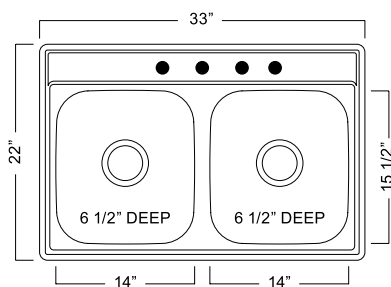

Accessorize with:



FDS703N (3 faucet holes, sleeve packaging)
FDS703NB (3 faucet holes, box packaging)

FDS704N (4 faucet holes, sleeve packaging)
FDS704NB (4 faucet holes, box packaging)

Gauge: 21
Finish: Satin Deck & Bowls
Minimum Cabinet Width: 36"

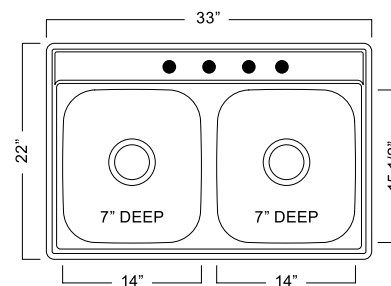

Accessorize with:



FDS803N (3 faucet holes, sleeve packaging)
FDS803NB (3 faucet holes, box packaging)

FDS804N (4 faucet holes, sleeve packaging)
FDS804NB (4 faucet holes, box packaging)

Gauge: 20
Finish: Satin Deck & Bowls
Minimum Cabinet Width: 36"

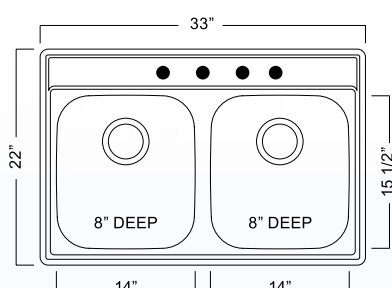

Accessorize with:



FEDG804BX

Gauge: 20
Finish: Satin Deck/Silk Bowls
Minimum Cabinet Width: 36"

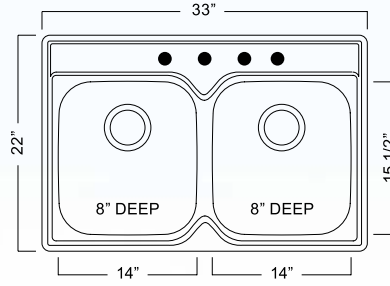

Accessorize with:



FCBA1614



FDDBA1614



FEDS803BX (3 faucet holes)

FEDS804BX (4 faucet holes)

Gauge: 20
Finish: Satin Deck & Bowls
Minimum Cabinet Width: 36"

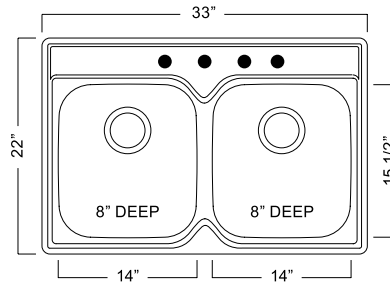

Accessorize with:



FCBA1614



FDDBA1614



FMSB654NB

Gauge: 22
Finish: Satin Deck & Bowls
Minimum Cabinet Width: 36"

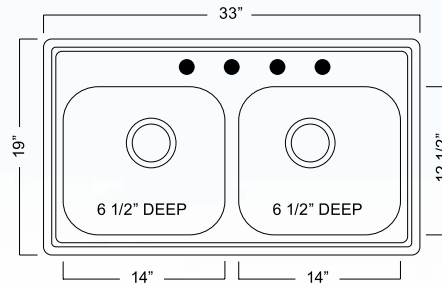

IDEAL FOR MODULAR HOMES

FPDS604 (sleeve packaging)

FPDS604B (box packaging)

Gauge: 21
Finish: Satin Deck & Bowls
Minimum Cabinet Width: 36"

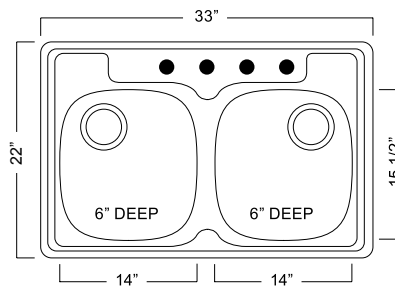

Accessorize with:



FCBA1614



FDBA1614



ADA COMPLIANT



C2233R/9

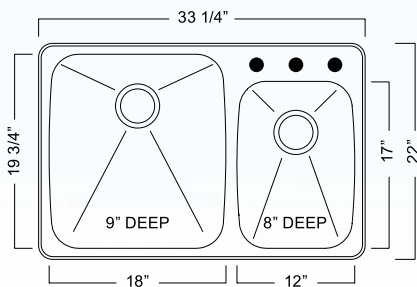

DUAL MOUNT, DRAIN LINES

Gauge: 18
Finish: Silk Deck/Satin Bowls
Minimum Cabinet Width: 36"

Accessorize with:



FBG140S



FBG60S



FMB1710

LSK853BX (3 faucet holes)

LSK854BX (4 faucet holes)

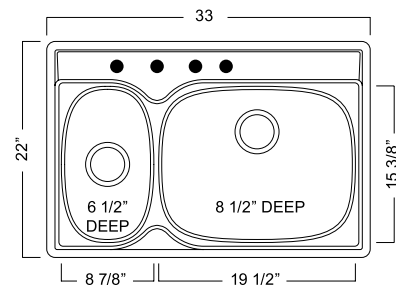

Gauge: 20
Finish: Satin Deck/Silk Bowls
Minimum Cabinet Width: 36"

Accessorize with:



FBGRB2016



FCBB2016



FCLC167



FDBA1614

OMSK951-18BX (1 faucet hole)

OMSK954-18BX (4 faucet holes)

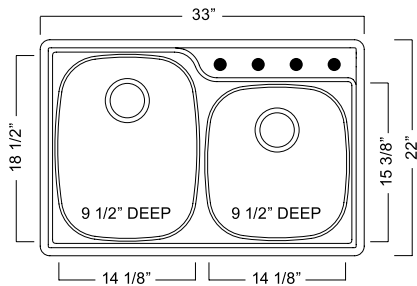

Gauge: 18
Finish: Mirror Deck/Silk Bowls
Minimum Cabinet Width: 36"

Accessorize with:



FBGRD1915



FCBA1614



FDBA1614

OSK951-18BX (1 faucet hole)

OSK954-18BX (4 faucet holes)

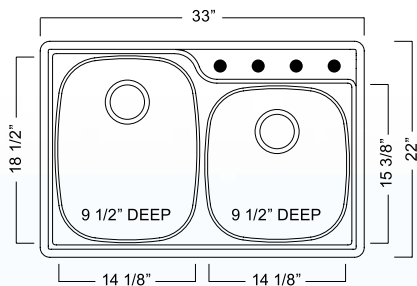

Gauge: 18
Finish: Satin Deck/Silk Bowls
Minimum Cabinet Width: 36"

Accessorize with:



FBGRD1915



FCBA1614



FDBA1614

OSK951BX (1 faucet hole)
OSK954BX (4 faucet holes)

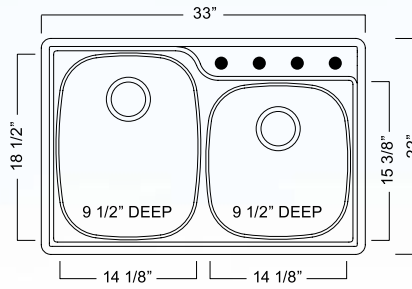

Gauge: 20
 Finish: Satin Deck/Silk Bowls
 Minimum Cabinet Width: 36"

Accessorize with:



FBGRD1915



FCBA1614



FDDBA1614

OSKD954-18BX

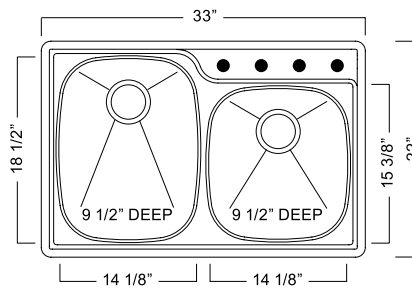

DRAIN LINES

Gauge: 18
 Finish: Satin Deck/Silk Bowls
 Minimum Cabinet Width: 36"

Accessorize with:



FBGRD1915



FCBA1614



FDDBA1614

FCR804BX

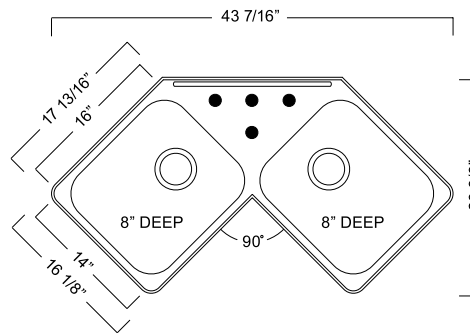

Gauge: 20
 Finish: Satin Deck/Silk Bowls
 Minimum Cabinet Width: 36"

Accessorize with:



FDDBA1614



FBG105

OTSK951-18BX (1 faucet hole)
OTSK954-18BX (4 faucet holes)

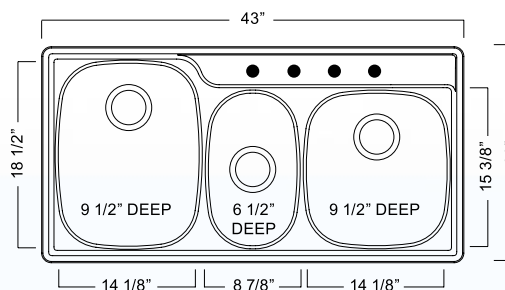

Gauge: 18
 Finish: Satin Deck/Silk Bowls
 Minimum Cabinet Width: 45"

Accessorize with:



FBGRD1915



FCBA1614



FCLC167



FGD75

OTSK951BX (1 faucet hole)
OTSK954BX (4 faucet holes)

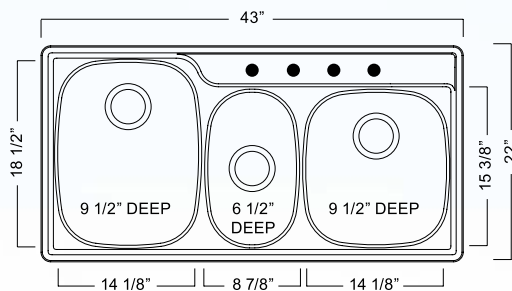

Gauge: 20
 Finish: Satin Deck/Silk Bowls
 Minimum Cabinet Width: 45"

Accessorize with:



FSUG100-18BX

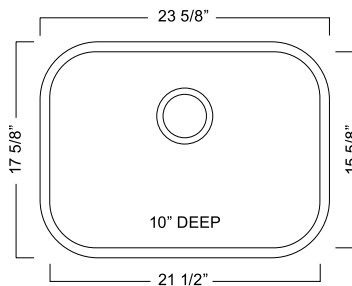

Gauge: 18
 Finish: Silk Rim & Bowl
 Minimum Cabinet Width: 27"

Accessorize with:



FSUG800-18BX

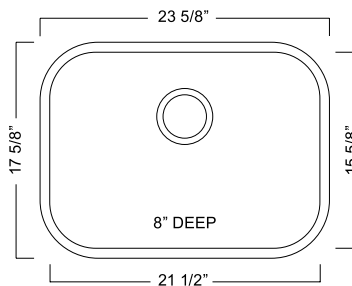

Gauge: 18
 Finish: Silk Rim & Bowl
 Minimum Cabinet Width: 27"

Accessorize with:



FSUG800-20BX

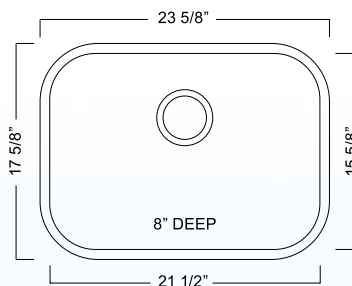

Gauge: 20
 Finish: Silk Rim & Bowl
 Minimum Cabinet Width: 27"

Accessorize with:



FSUG900-18BX

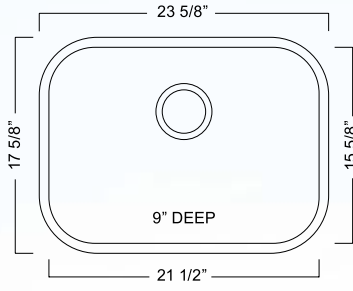

Gauge: 18
Finish: Silk Rim & Bowl
Minimum Cabinet Width: 27"

Accessorize with:



FGS75

FSU117

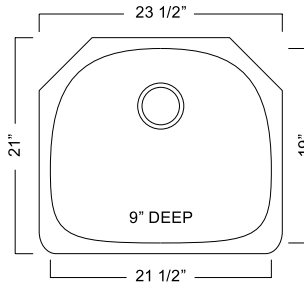

Gauge: 18
Finish: Silk Rim & Bowl
Minimum Cabinet Width: 27"

Accessorize with:



FBG1821

FSU118

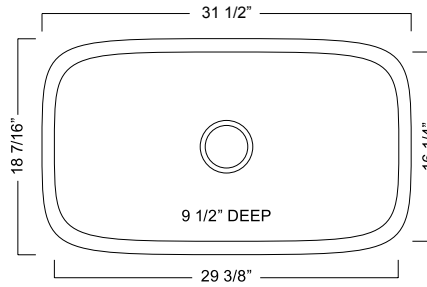

Gauge: 18
Finish: Silk Rim & Bowl
Minimum Cabinet Width: 36"

Accessorize with:



FBG2714

UDTS24/10

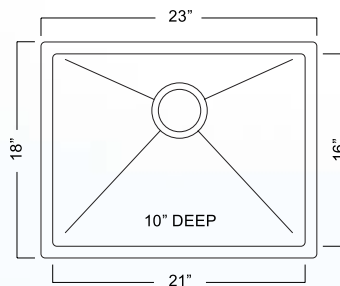

Gauge: 18
Finish: Satin Rim & Bowl
Minimum Cabinet Width: 27"

DRAIN LINES

UDTS30/10

Gauge: 18
 Finish: Satin Rim & Bowl
 Minimum Cabinet Width: 33"

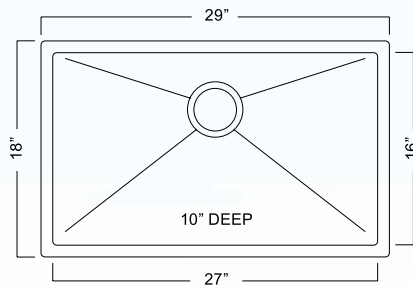

DRAIN LINES

UDTS32/10

Gauge: 18
 Finish: Satin Rim & Bowl
 Minimum Cabinet Width: 33"

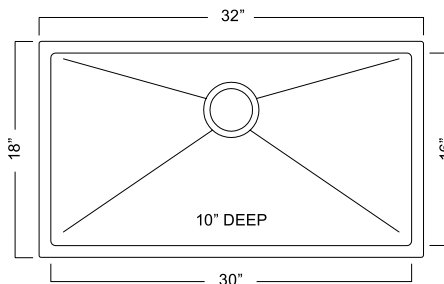

DRAIN LINES

USASK900-18

Gauge: 18
 Finish: Silk Rim & Bowl
 Minimum Cabinet Width: 18"

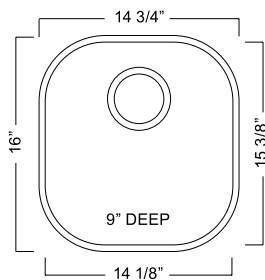

Accessorize with:



FGD75



USBSK800-18

Gauge: 18
 Finish: Silk Rim & Bowl
 Minimum Cabinet Width: 24"

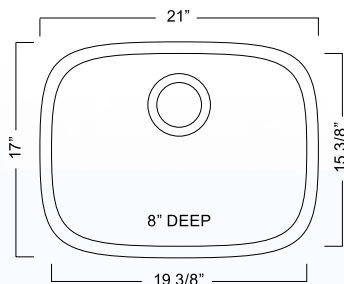

Accessorize with:



FBGRB2016



USCSK600

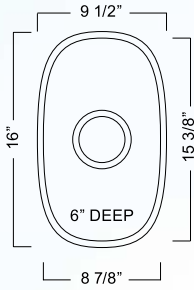

Gauge: 20
Finish: Silk Rim & Bowl
Minimum Cabinet Width: 15"

Accessorize with:



FCLC167

USDSK900-18

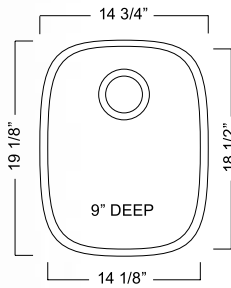

Gauge: 18
Finish: Silk Rim & Bowl
Minimum Cabinet Width: 18"

Accessorize with:



FBGRD1915

USSK800-18

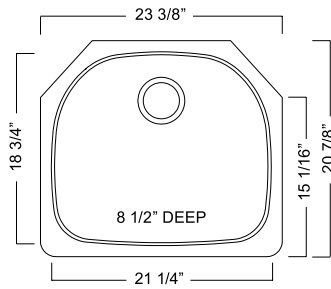

Gauge: 18
Finish: Silk Rim & Bowl
Minimum Cabinet Width: 27"

Accessorize with:



FBG20S

FUD800BX

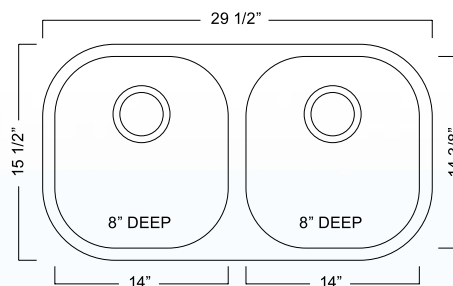

Gauge: 20
Finish: Silk Rim/Satin Bowls
Minimum Cabinet Width: 33"

Accessorize with:



FCBU1614



FDBA1614



FGD75



FUDG800-18BX

Gauge: 18
Finish: Silk Rim & Bowls
Minimum Cabinet Width: 33"

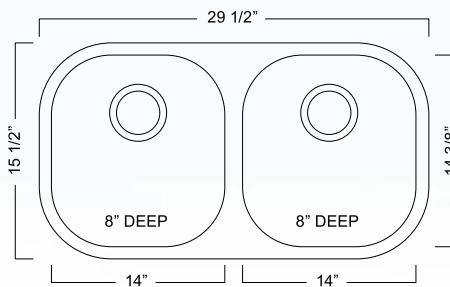

Accessorize with:



FCBU1614



FDBA1614



FGD75



UDSK900-18

Gauge: 18
Finish: Silk Rim & Bowls
Minimum Cabinet Width: 36"

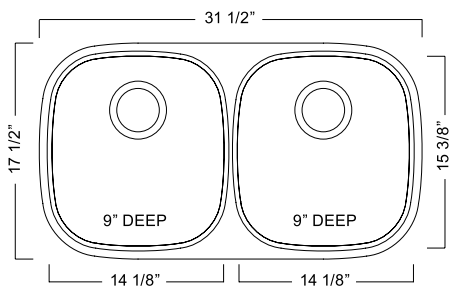

Accessorize with:



FCBU1614



UDTD32/10

Gauge: 18
Finish: Radiant Satin Rim & Bowls
Minimum Cabinet Width: 36"

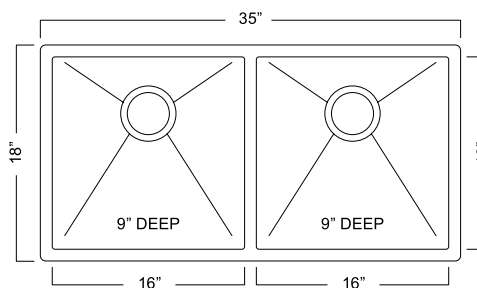

DRAIN LINES

UDTF33/10

Gauge: 18
Finish: Radiant Satin Rim & Bowls
Minimum Cabinet Width: 36"

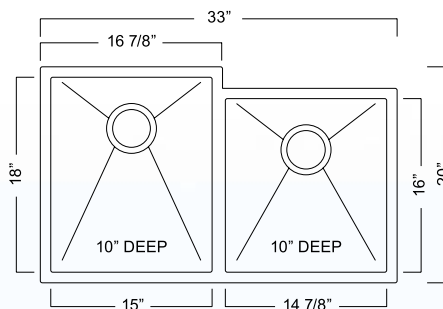

DRAIN LINES

UOSK900-18

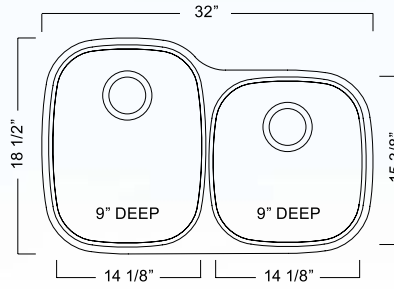

Gauge: 18
Finish: Silk Rim & Bowls
Minimum Cabinet Width: 36"

Accessorize with:



FBGRD1915



FCBU1614



FDBA1614

FCU104

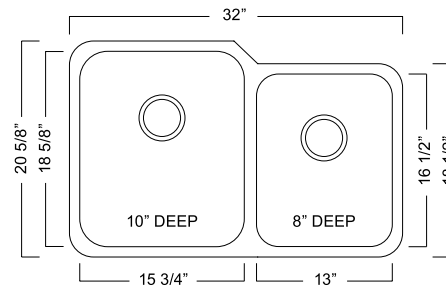

Gauge: 18
Finish: Silk Rim & Bowls
Minimum Cabinet Width: 36"

FCU115

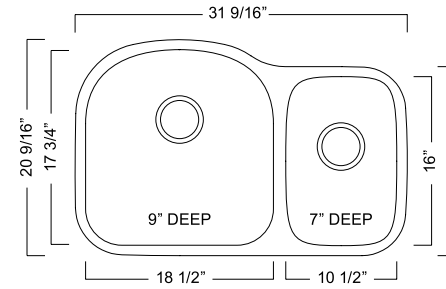

Gauge: 18
Finish: Silk Rim & Bowls
Minimum Cabinet Width: 36"

FCU116

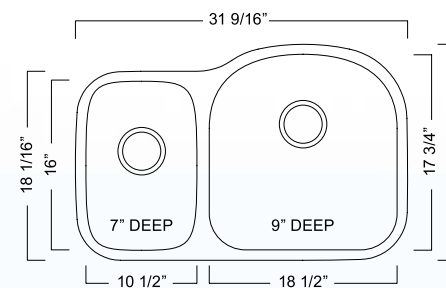

Gauge: 18
Finish: Silk Rim & Bowls
Minimum Cabinet Width: 36"

FCU120

Gauge: 18
Finish: Silk Rim & Bowls
Minimum Cabinet Width: 36"

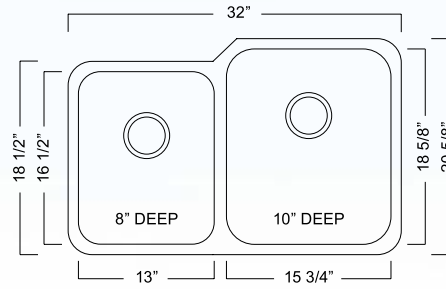

FFS30B-10-18

Gauge: 18
Finish: Satin Rim & Bowl
Minimum Cabinet Width: 30"

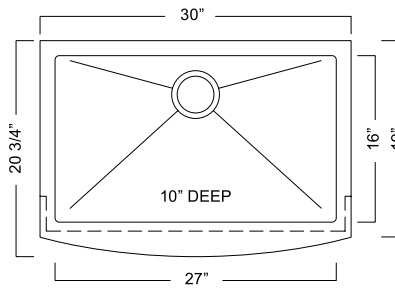

Comes with:



Strainer

DRAIN LINES

FFS33B-10-18

Gauge: 18
Finish: Satin Rim & Bowl
Minimum Cabinet Width: 33"

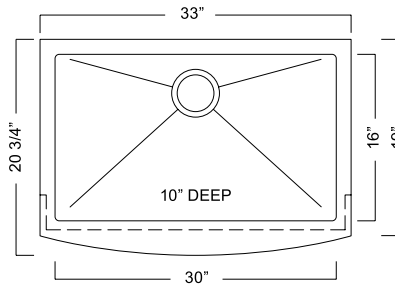

Comes with:



Strainer

DRAIN LINES

FFD33B-9-18

Gauge: 18
Finish: Satin Rim & Bowls
Minimum Cabinet Width: 33"

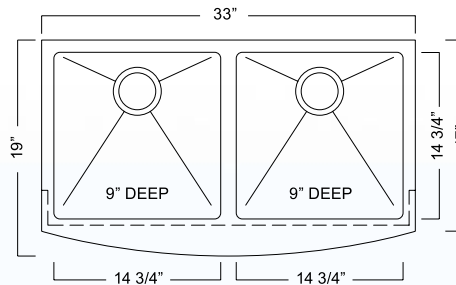

Comes with:



2 Strainers

DRAIN LINES

FFD36B-9-18

Gauge: 18
 Finish: Satin Rim & Bowls
 Minimum Cabinet Width: 36"

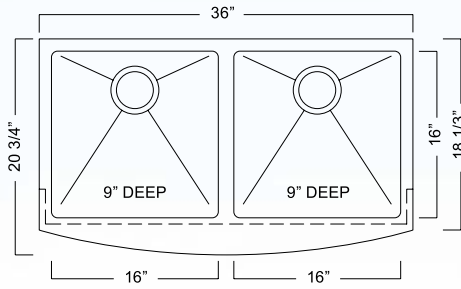

Comes with:



2 Strainers

DRAIN LINES

FBFS602NKIT

Gauge: 22
 Finish: Satin Deck & Bowl
 Minimum Cabinet Width: 18"

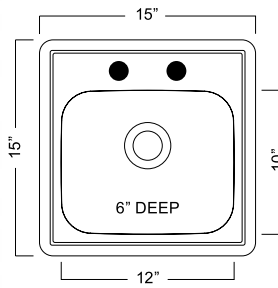

Comes with:



Chrome Faucet



Strainer



FSS704NKIT

Gauge: 21
 Finish: Satin Deck & Bowl
 Minimum Cabinet Width: 27"

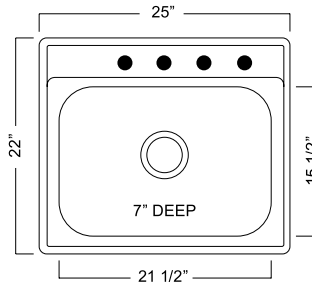

Comes with:



Chrome Faucet with Side Spray

Accessorize with:



FGS50



Strainer



FDS704NKIT

Gauge: 21
 Finish: Satin Deck & Bowls
 Minimum Cabinet Width: 36"

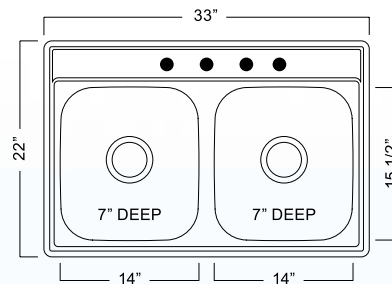

Comes with:



Chrome Faucet with Side Spray

Accessorize with:



FDBA1614



2 Strainers



If bringing color into your kitchen is important to you, FrankeUSA composite granite sinks provide a wide variety of color options, along with a wide variety of practical features. To sum it up, these sinks are tough. Scratch, stain and chip resistant, our composite granite sinks can take a beating and still look beautiful. In fact, if you drag a fork across the surface of any of these sinks, you'll notice that the line left behind is debris from the fork (which can be easily scrubbed off)! On top of their resilience, our granite sinks also provide defense against germs with Sanitized®.

What is Sanitized®? This is a Franke-exclusive protective barrier added during the manufacturing process which fights bacteria on the sink surface - even in between cleanings!

A woman with long brown hair in a ponytail, wearing a blue and white striped polo shirt, is shown in profile from the chest up. She is looking towards the right side of the frame. In the background, there is a white subway tile backsplash and a white kitchen sink. To the right of the sink, a bunch of fresh green basil is visible. The bottom of the image features a red geometric pattern.

Composite Granite
Elegance meets durability.



- Heat resistant up to 536°F
- Scratch, stain and chip resistant
- Sanitized® exclusive built-in protective barrier
- Dual mount
- Limited lifetime warranty

To Clean:

For best results, opt for a mild liquid soap and a wet cloth to gently clean your sink. Mild abrasives and a non-metallic sponge can be used for more aggressive cleaning. Rinse thoroughly.

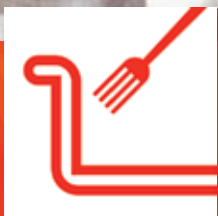

Scratch & Stain Resistant

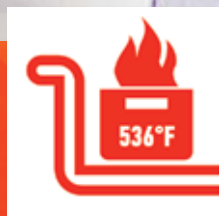

Heat Resistant

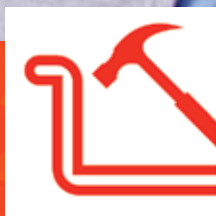

Chip Resistant



Exclusive Built-in Protective Barrier

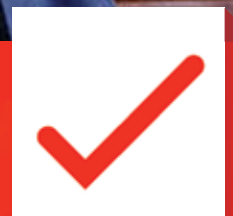

Limited Lifetime Warranty

SOX1720-1 (Onyx)
SZCH1720-1 (Champagne)



SZGR1720-1 (Graphite)
SZPW1720-1 (White)

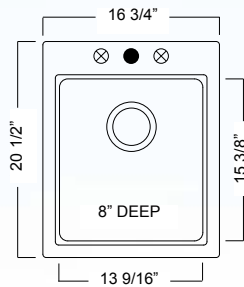

Shown in Champagne
DUAL MOUNT

Minimum Cabinet Width: 18"

Comes in:



Graphite

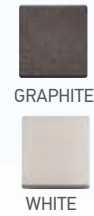

Accessorize with:



SC2522-1 (Champagne)
SGR2522-1 (Graphite)



SOX2522-1 (Onyx)
SW2522-1 (White)

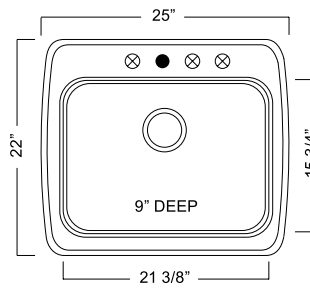

Shown in Champagne
DUAL MOUNT

Minimum Cabinet Width: 27"

Comes in:



Graphite

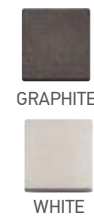

Accessorize with:



ESCH25229-1 (Champagne)
ESDB25229-1 (Mocha)



ESOX25229-1 (Onyx)

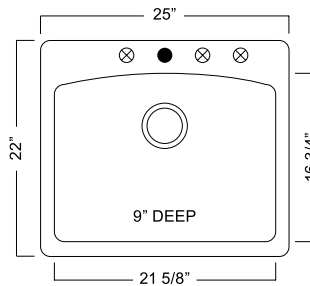

Shown in Onyx
DUAL MOUNT

Minimum Cabinet Width: 27"

Comes in:



Mocha

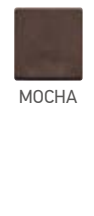

Accessorize with:



SC3322-1 (Champagne)
SGR3322-1 (Graphite)



SP3322-1 (White)

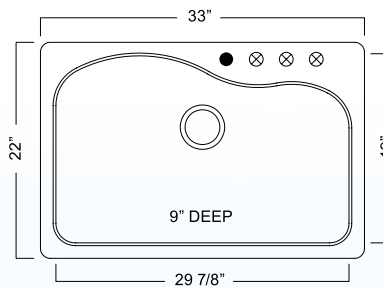

Shown in Champagne
DUAL MOUNT

Minimum Cabinet Width: 36"

Comes in:



Graphite

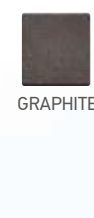

Accessorize with:



EDCH33229-1 (Champagne)
EDDB33229-1 (Mocha)

EDOX33229-1 (Onyx)

Minimum Cabinet Width: 36"

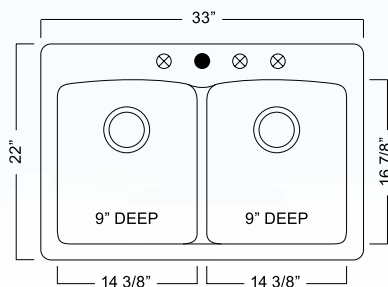

Comes in:



Accessorize with:



Shown in Mocha
DUAL MOUNT

DCH3322-1 (Champagne)
DGR3322-1 (Graphite)

DP3322-1 (White)

Minimum Cabinet Width: 36"

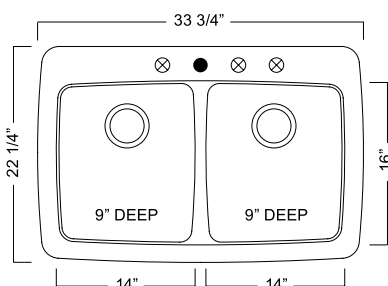

Comes in:



Accessorize with:



Shown in Champagne
DUAL MOUNT

FPC3322-1 (Champagne)
FPM3322-1 (Mocha)

FP03322-1 (Onyx)
FPW3322-1 (White)

Minimum Cabinet Width: 36"

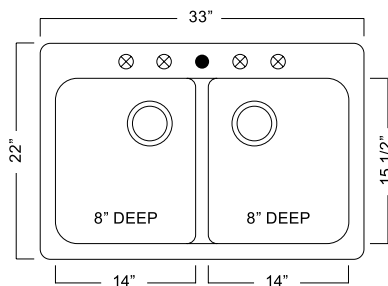

Comes in:



Shown in Champagne
DUAL MOUNT

EOCH33229-1 (Champagne)
EODB33229-1 (Mocha)

E0OX33229-1 (Onyx)

Minimum Cabinet Width: 36"

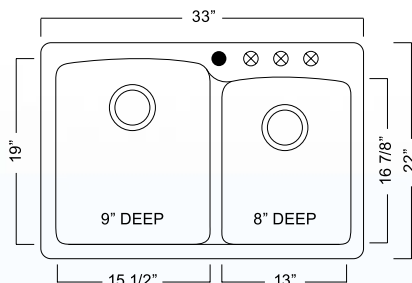

Comes in:



Accessorize with:



Shown in Onyx
DUAL MOUNT

OC3322-1 (Champagne)
OGR3322-1 (Graphite)

OW3322-1 (White)

Minimum Cabinet Width: 36"

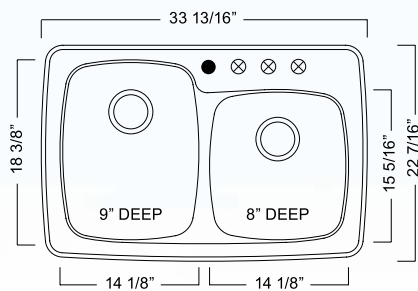

Comes in:



CHAMPAGNE

WHITE



GRAPHITE

Accessorize with:



FBGG1614



FBGRD1915



FCBG1614



FDBA1614

Shown in White
DUAL MOUNT



Tectonite® sinks are strong and durable yet amazingly lightweight. This Franke-exclusive material is a great option for those who want a color sink, but need a more budget-friendly price.

- Heat resistant up to 572°F
- Scratch, stain and heat resistant
- Dual mount
- Limited lifetime warranty

To Clean:

For best results, opt for a mild liquid soap and a wet cloth to gently clean your sink. After cleaning, rinse thoroughly and towel dry.

Tectonite®

Tough enough to handle your most important jobs.



Scratch & Stain Resistant



Heat Resistant



Chip Resistant



Limited Lifetime Warranty

FTB904BX (Black)
FTO904BX (Oatmeal)

FTW904BX (White)

Minimum Cabinet Width: 36"

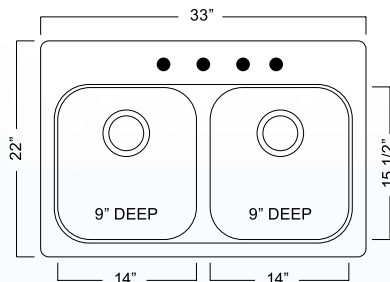

Comes in:



BLACK



WHITE



OATMEAL

Accessorize with:



FBGG1614

Shown in Oatmeal
DUAL MOUNT

TECTONITE®

Now it's easy to take care of the sink that takes care of you! Custom-fit and universal sink accessories provide care and protection for your sink, while bringing improved functionality and organization to the entire kitchen!

Accessories

Find the perfect match for your new sink.

FAB100
FAB1006PK (6 pack)

UNIVERSAL ACCESSORY

Fits across most standard sinks



Stainless Steel Adjustable Basket – 13 1/8" x 9 7/8" x 3 1/8"

FSB100
FSB1006PK (6 pack)

UNIVERSAL ACCESSORY

Attaches to most sinks



Stainless Steel Sponge Basket – 5 1/2" x 2 7/8" x 2 1/4"

- **Grids** to protect your sink bottom from scratches
- **Baskets & colanders** to rinse food and dry dishes
- **Cutting boards** for slicing and dicing
- **Roll mats & other cool stuff** for every job under the sun (well, almost.)

To Clean:

STAINLESS STEEL: Follow the instructions on page 7. **WOOD:** To disinfect, wipe down with full-strength white vinegar, which kills E. coli, salmonella and Staph. Rinse with a clean cloth dipped in cold water. Polish with food-safe mineral oil to maintain finish. **GLASS:** Dishwasher safe.



Sure Grip Feet



Rubber Grip



Adjustable Handles



Solid Wood

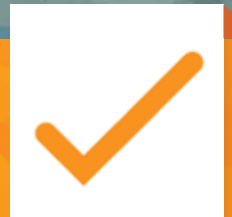

1 Year Warranty

FDR1614



Stainless Steel Dish Rack – 10 1/2" x 6 1/2"

UNIVERSAL ACCESSORY

FCB100
FCB1004PK (4 pack)



Wooden Cutting Board – 18" x 12"

UNIVERSAL ACCESSORY

Fits across most standard sinks

FMB100



Wooden Cutting Board – 24 11/16" x 11 15/16"

UNIVERSAL ACCESSORY

Fits across most standard sinks

FGD50

FGD506PK (6 pack)

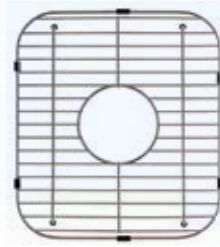

Stainless Steel Grid – 13 1/8" x 11 5/8"

UNIVERSAL ACCESSORY

Fits most double bowl sinks w/ center drains

FGD75

FGD756PK (6 pack)



Stainless Steel Grid – 13 1/8" x 11 5/8"

UNIVERSAL ACCESSORY

Fits most double bowl sinks w/ rear drains

FGS50

FGS504PK (4 pack)

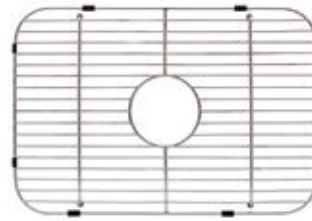

Stainless Steel Grid – 13 1/2" x 19 1/2"

UNIVERSAL ACCESSORY

Fits most single bowl sinks w/ center drains

FGS75

FGS754PK (4 pack)

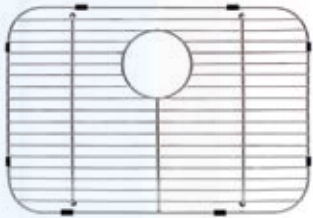

Stainless Steel Grid – 13 1/2" x 19 1/2"

UNIVERSAL ACCESSORY

Fits most single bowl sinks w/ rear drains

FRM100

FRM1006PK (6 pack)



Stainless Steel Roll Mat – 17 1/4" x 14 1/4"

UNIVERSAL ACCESSORY

Fits across most standard sinks

FUH4



Stainless Steel Utensil Holder – 8 1/4" Tall x 4 1/4" Diameter

UNIVERSAL ACCESSORY

4010856 (Satin Nickel)



Stainless Steel Sink Strainer – 3 1/2" Diameter

UNIVERSAL ACCESSORY

Fits standard drain hole dimensions

FDBA1614



Stainless Steel Basket – 14 3/4" x 13 5/8"

DMSK954-18BX
DSK851BX
DSK851-18BX
DSK854BX
DSK854-18BX
DSK951BX
DSK951-18BX
DSK954BX
DSK954-18BX
DSKD954-18BX
FBFG904BX
FCR804BX
FDG804NB

FDMG804NB
FDS603N
FDS603NB
FDS604N
FDS604NB
FDS654-20N
FDS654-20NB
FDS654N
FDS654NB
FDS703N
FDS703NB
FDS704N
FDS704NB

FDS704NKIT
FDS803N
FDS803NB
FDS804N
FDS804NB
FEDG804BX
FEDS803BX
FEDS804BX
FPDS604
FPDS604B
FUD800BX
FUDG800-18BX
LSK853BX

Custom fit for:

LSK854BX
OMSK951-18BX
OMSK954-18BX
OSK951BX
OSK951-18BX
OSK954BX
OSK954-18BX
OSKD954-18BX
OC3322-1
OGR3322-1
OW3322-1
UOSK900-18

FDBR10S



Stainless Steel Dish Rack – 14 5/8" x 12"

Custom fit for:

A1933/9
A2233/9
DCH3322-1
DFD901BX
DGR3322-1
DP3322-1
EDCH33229-1
EDDB33229-1
EDOX33229-1
FBFG904BX

FC50S



Stainless Steel Colander – 15 11/16" x 6 3/16" x 2 1/4"

Custom fit for:

SOX1720-1
SZCH1720-1
SZGR1720-1
SZPW1720-1

FCLC167



Stainless Steel Colander – 15 1/2" x 7"

Custom fit for:

LSK853BX
LSK854BX
OTSK951-18BX
OTSK951BX
OTSK954-18BX
OTSK954BX
USCSK600

FCBA1614



Wooden Cutting Board – 13" x 14 1/2"

Custom fit for:

DMSK954-18BX
DSKD954-18BX
DSK851-18BX
DSK851BX
DSK854-18BX
DSK854BX
DSK951-18BX
DSK951BX
DSK954-18BX
DSK954BX
FEDG804BX
FEDS803BX
FEDS804BX
FPDS604
FPDS604B
OMSK951-18BX
OMSK954-18BX
OSKD954-18BX
OSK951-18BX
OSK951BX
OSK954-18BX
OSK954BX
OTSK951-18BX
OTSK951BX
OTSK954-18BX
OTSK954BX

FCBB2016



Wooden Cutting Board – 12 3/4" x 20"

Custom fit for:

LSK853BX
LSK854BX

FCBG1614



Wooden Cutting Board – 14 3/4" x 16"

Custom fit for:

OC3322-1
OGR3322-1
OW3322-1

FCBG2116



Wooden Cutting Board – 14 1/2" x 22"

Custom fit for:

- SC2522-1
- SGR2522-1
- SOX2522-1
- SW2522-1

FCBU2216



Wooden Cutting Board – 12 3/4" x 22 1/8"

Custom fit for:

- FPSS604R
- FPSS604RB

FCBU1614



Wooden Cutting Board – 13 1/2" x 14 1/2"

Custom fit for:

- FUDG800-18BX
- FUD800BX
- UDSK900-18
- UOSK900-18

FGB50



Glass Cutting Board – 16" x 11"

Custom fit for:

- SOX1720-1
- SZCH1720-1
- SZGR1720-1
- SZPW1720-1

FMB1710



Wooden Cutting Board – 18" x 11"

Custom fit for:

- A2225/9
- BMSK802
- BMSK803
- C2233R/9

FMB50



Wooden Cutting Board – 16 1/16" x 12"

Custom fit for:

- SOX1720-1
- SZCH1720-1
- SZGR1720-1
- SZPW1720-1

FBBG2716



Stainless Steel Grid – 16 1/2" x 27"

Custom fit for:

- SC3322-1
- SGR3322-1
- SP3322-1

FBG10S



Stainless Steel Grid – 14 1/4" x 11 7/8"

Custom fit for:

- FCR804BX

FBG110S

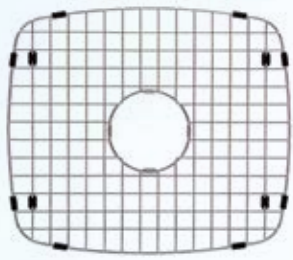

Stainless Steel Grid – 15 7/8" x 17 7/8"

Custom fit for:

SL103BX

FBG180S

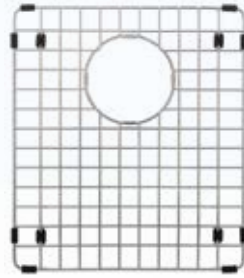

Stainless Steel Grid – 13 5/8" x 11 7/8"

Custom fit for:

SOX1720-1
SZCH1720-1
SZGR1720-1
SZPW1720-1

FBG140S

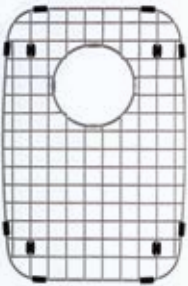

Stainless Steel Grid – 15 1/4" x 11 1/4"

Custom fit for:

C2233R/9

FBG1821

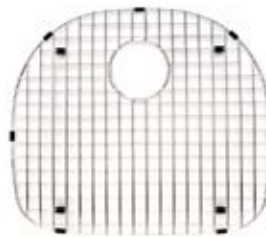

Stainless Steel Grid – 15 1/2" x 11 1/4"

Custom fit for:

FSG902-18BX
FSU117

FBG20S

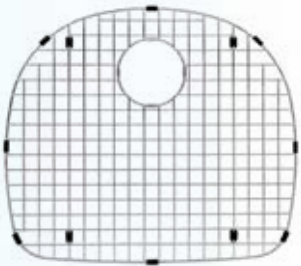

Stainless Steel Grid – 17 1/8" x 19 9/16"

Custom fit for:

USSK800-18

FBG2714

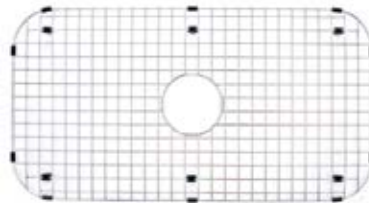

Stainless Steel Grid – 14 1/4" x 27 1/4"

Custom fit for:

FSLG804BX
FSU118

FBG60S

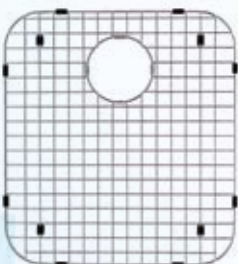

Stainless Steel Grid – 17 1/2" x 15 7/8"

Custom fit for:

C2233R/9

FBG65S

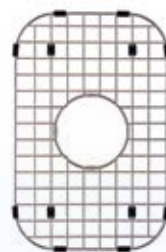

Stainless Steel Grid – 14 3/4" x 9 1/2"

Custom fit for:

BMSK802
BMSK803

FBG80S

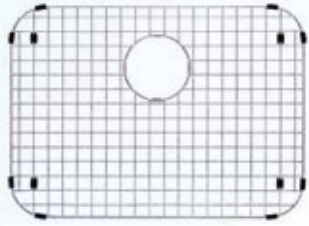

Stainless Steel Grid – 14 3/4" x 20 3/8"

Custom fit for:

A2225/9

FBGA1517S



Stainless Steel Grid – 15" x 12 7/8"

Custom fit for:

A1933/9
A2233/9

FBGD1915



Stainless Steel Grid – 15 1/2" x 11 1/4"

Custom fit for:

DFD901BX

FBGG1014



Stainless Steel Grid – 14" x 10"

Custom fit for:

EOCH33229-1
EODB33229-1
E0OX33229-1

FBGG1114

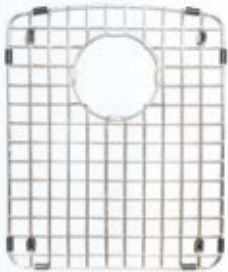

Stainless Steel Grid – 14" x 11 1/2"

Custom fit for:

DCH3322-1
DGR3322-1
DP3322-1
EDCH33229-1
EDDB33229-1
EDOX33229-1

FBGG1316

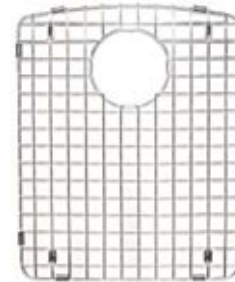

Stainless Steel Grid – 16" x 12 3/4"

Custom fit for:

EOCH33229-1
EODB33229-1
E0OX33229-1

FBGG1614



Stainless Steel Grid – 13 1/4" x 12"

Custom fit for:

FTB904BX
FTO904BX
FTW904BX
OC3322-1
OGR3322-1
OW3322-1

FBGG1914

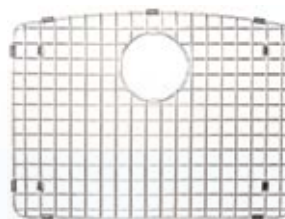

Stainless Steel Grid – 13 3/4" x 18 3/4"

Custom fit for:

ESCH25229-1
ESDB25229-1
ESOX25229-1

FBGL1613

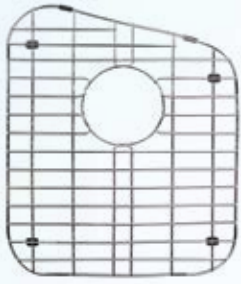

Stainless Steel Grid – 15 3/4" x 13"

Custom fit for:

FBFG904BX

FBGRB2016

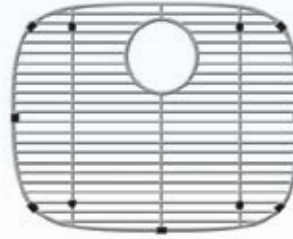

Stainless Steel Grid – 12 1/2" x 16 1/2"

Custom fit for:

LSK853BX
LSK854BX
USBSK800-18

FBGR1613

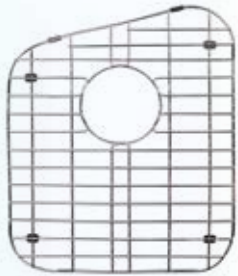

Stainless Steel Grid – 15 3/4" x 13"

Custom fit for:

FBFG904BX

FBGRD1915

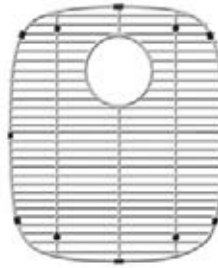

Stainless Steel Grid – 15 1/2" x 11 1/4"

Custom fit for:

OC3322-1
OGR3322-1
OMSK951-18BX
OMSK954-18BX
OSKD954-18BX
OSK951BX
OSK951-18BX
OSK954BX
OSK954-18BX
OTSK951BX
OTSK951-18BX
OTSK954BX
OTSK954-18BX
OW3322-1
UOSK900-18
USDSK900-18

FRM50S



Stainless Steel Roll Mat – 15 7/8" x 13 3/4"

Custom fit for:

SOX1720-1
SZCH1720-1
SZGR1720-1
SZPW1720-1

Warranty

Sinks

FrankeUSA warrants all sinks to be free from manufacturing defects in material and workmanship, under the normal residential use for which it was intended, for the lifetime of the sink.

Accessories

FrankeUSA warrants all accessories to be free from manufacturing defects in material and workmanship, under the normal residential use for which it was intended, for a period of one (1) year from the date of purchase.

Faucets

FrankeUSA warrants all faucets included with FrankeUSA sinks kits to be free from manufacturing defects in material and workmanship, under the normal residential use for which they were intended, for the lifetime of the faucet.

Marine & Outdoor Installation

FrankeUSA sinks, accessories and faucets are not warranted for marine or outdoor installation.

For detailed information on our warranties, go to www.frankeusa.com or call 1-800-637-6485 to speak to a FrankeUSA Customer Service Team Member.

Customer Service

Thank you for viewing our product catalog. If you have questions about any of the listed items, please go to www.frankeusa.com or contact the FrankeUSA Customer Service Team.

Customer Service Department

3050 Campus Drive, Ste. 500

Hatfield, PA 19440

E-mail: customerservice.fus@franke.com

Tel: 1-800-637-6485

Fax: 1-800-789-6201



Index

ACCESSORIES

BASKETS/RACKS

FAB100	34
FAB1006PK	34
FDBA1614	37
FDBR10S	37
FDR1614	35
FSB100	34
FSB1006PK	34

COLANDERS

FC50S	37
FCLC167	37

CUTTING BOARDS

FCB100	35
FCB1004PK	35
FCBA1614	37
FCBB2016	37
FCBG1614	37
FCBG2116	38
FCBU1614	38
FCBU2216	38
FGB50	38
FMB100	36
FMB1710	38
FMB50	38

GRIDS/MATS

FBBG2716	38
FBG10S	38
FBG110S	39
FBG140S	39
FBG180S	39
FBG1821	39
FBG20S	39
FBG2714	39
FBG60S	39
FBG65S	39
FBG80S	40
FBGA1517S	40
FBGD1915	40
FBGG1014	40
FBGG1114	40
FBGG1316	40
FBGG1614	40
FBGG1914	40
FBGL1613	41
FBGR1613	41
FBGRB2016	41
FBGRD1915	41
FGD50	36
FGD506PK	36
FGD75	36
FGD756PK	36
FGS50	36
FGS504PK	36
FGS75	36
FGS754PK	36

MISCELLANEOUS

4010856	36
FRM50S	41
FRM100	36
FRM1006PK	36
FUH4	36

COMPOSITE GRANITE SINKS

DUAL MOUNT

DCH3322-1	31
DGR3322-1	31
DP3322-1	31
EDCH33229-1	31
EDDB33229-1	31
EDOX33229-1	31
EOCH33229-1	31
EODB33229-1	31
EODX33229-1	31

ESCH25229-1	30
ESDB25229-1	30
ESOX25229-1	30
FPC3322-1	31
FPM3322-1	31
FPO3322-1	31
FPW3322-1	31
OC3322-1	32
OGR3322-1	32
OW3322-1	32
SC2522-1	30
SC3322-1	30
SGR2522-1	30
SGR3322-1	30
SOX1720-1	30
SOX2522-1	30
SP3322-1	30
SW2522-1	30
SZCH1720-1	30
SZGR1720-1	30
SZPW1720-1	30

STAINLESS STEEL SINKS

TOPMOUNT

A1933/9	11
A2233/9	12
A2225/9	8
BMSK802	10
BMSK803	10
C2233R/9	18
DFD901BX	12
DMSK954-18BX	12
DSK851-18BX	12
DSK854-18BX	12
DSK851BX	13
DSK854BX	13
DSK951-18BX	13
DSK954-18BX	13
DSK951BX	13
DSK954BX	13
DSKD954-18BX	13
FBS602N	11
FBS602NB	11
FBS602-35NB	10
FBFG904BX	14
FCR804BX	19
FDG804NB	14
FDMG804NB	14
FDS603N	14
FDS603NB	14
FDS604N	14
FDS604NB	14
FDS654-20N	15
FDS654-20NB	15
FDS654N	15
FDS654NB	15
FDS703N	15
FDS703NB	15
FDS704N	15
FDS704NB	15
FDS803N	15
FDS803NB	15
FDS804N	15
FDS804NB	15
FEDG804BX	16
FEDS803BX	16
FEDS804BX	16
FMSB654NB	17
FPDS604	17
FPDS604B	17
FPSS604R	8
FPSS604RB	8
FSG804NB	8
FSG902-18BX	11

FSLG804BX	8
FSS603N	9
FSS603NB	9
FSS604N	9
FSS604NB	9
FSS703N	9
FSS703NB	9
FSS704N	9
FSS704NB	9
FSS803N	9
FSS803NB	9
FSS804N	9
FSS804NB	9
LSK853BX	18
LSK854BX	18
OMSK951-18BX	18
OMSK954-18BX	18
OSK951-18BX	18
OSK954-18BX	18
OSK951BX	19
OSK954BX	19
OSKD954-18BX	19
OTSK951-18BX	19
OTSK954-18BX	19
SL103BX	11
SSK104NB	9
SSK854NB	10
SSKD104NB	10

UNDERMOUNT

FCU104	25
FCU115	25
FCU116	25
FCU120	26
FSU117	21
FSU118	21
FSUG100-18BX	20
FSUG800-18BX	20
FSUG800-20BX	20
FSUG900-18BX	21
FUD800BX	23
FUDG800-18BX	24
OTSK951BX	20
OTSK954BX	20
UDTD32/10	24
UDTF33/10	24
UDSK900-18	24
UDTS24/10	21
UDTS30/10	22
UDTS32/10	22
UOSK900-18	25
USASK900-18	22
USBSK800-18	22
USCSK600	23
USDSK900-18	23
USSK800-18	23

FARMHOUSE

FFD33B-9-18	26
FFD36B-9-18	27
FFS30B-10-18	26
FFS33B-10-18	26

SINK KITS

FBFS602NKIT	27
FDS704NKIT	27
FSS704NKIT	27

TECTONITE® SINKS

DUAL MOUNT

FTB904BX	33
FTO904BX	33
FTW904BX	33



Life is more moving when
you can stay in motion.

Daily tasks are less when
you don't have the stress.

And big things are possible
when the little things are done.

We make products that support these
essentials: to keep every day running
and make time more rewarding.

www.FrankeUSA.com