

Genesis

6" Bench Grinder with Lights

Meuleuse d'établi de 6 po, avec éclairages

Esmeriladora de banco de 6", con luces

Operator's Manual

Manuel d'utilisation

Manual del Operario



GBG600L

Operator's Manual

Specifications:

- Model: GBG600L
- Rated Voltage: 120V AC, 60HZ
- Rated Input Power: 1/2 HP (1.5 A)
- No Load Speed: 3550 RPM
- Wheel Size: 6"
- Shaft Diameter: 1/2"

Includes: (1)36G Wheel, (1) 60G Wheel and Light Bulbs

⚠ WARNING: To reduce the risk of injury, user must read and understand this operator's manual before operating this tool. Save this Manual for future reference.

Toll-Free Help Line: 1-888-552-8665



⚠ WARNING: The Operation of any power tool can result in foreign objects being thrown into your eyes, which can result in severe eye damage. Before beginning tool operation, always wear safety goggles or safety glasses with side shields and a full face shield when needed. We recommend Wide Vision Safety Mask for use over eyeglasses or standard safety glasses with side shields. Always wear eye protection which is marked to comply with ANSI Z87.1.



Look for this symbol to point out important safety precautions. It means attention!!! Your safety is involved.

GENERAL SAFETY RULES

⚠ WARNING:

Some dust created by power sanding, sawing, grinding, drilling, and other construction activities contains chemicals known to cause cancer, birth defects or other reproductive harm. Some examples of these chemicals are:

- Lead from lead-based paints,
- Crystalline silica from bricks and cement and other masonry products, and
- Arsenic and chromium from chemically treated lumber.

Your risk from these exposures varies, depending on how often you do this type of work. To reduce your exposure to these chemicals: work in a well ventilated area, and work with approved safety equipment, such as those dust masks that are specially designed to filter out microscopic particles.

⚠ WARNING: READ AND UNDERSTAND ALL WARNINGS, CAUTIONS AND OPERATING INSTRUCTIONS BEFORE USING THIS EQUIPMENT. Failure to follow all instructions listed below may result in electric shock, fire and/or serious personal injury.

SAVE THESE INSTRUCTIONS

WORK AREA SAFETY

- **Keep your work area clean and well lit.** Cluttered benches and dark areas invite accidents.
- **Do not operate power tools in explosive atmospheres,** such as in the presence of flammable liquids, gases, or dust. Power tools create sparks which may ignite the dust or fumes.
- **Keep bystanders, children, and visitors away while operating a power tool.** Distractions can cause you to lose control.

ELECTRICAL SAFETY

- **Power tool plugs must match the outlet.** Never modify the plug in any way. Do not use any adapter plugs in any earthed (grounded) power tools. Double insulated tools are equipped with a polarized plug (one blade is wider than the other). This plug will fit in a polarized outlet only one way. If the plug does not fit fully in the outlet, reverse the plug. If it still does not fit, contact a qualified electrician to install a polarized outlet. Do not change the plug in any way. Double insulation eliminates the need for the three wire grounded power cord and grounded power supply system.
- **Do not expose power tools to rain or wet conditions.** Water entering a power tool will increase the risk of electric shock.
- **Avoid body contact with earthed or grounded surfaces such as pipes, radiators, ranges and refrigerators.** There is an increased risk of electric shock if your body is grounded.
- **Do not abuse the cord.** Never use the cord for carrying, pulling or unplugging the power tool. Keep cord away from heat, oil, sharp edges or moving parts. Damaged cords increase the risk of electric shock.
- **When operating a power tool outside, use an extension cord suitable for outdoor use.** These cords are rated for outdoor use and reduce the risk of electric shock.
- **Do not use AC only rated tools with a DC power supply.** While the tool may appear to work. The electrical components of the AC rated tool are likely to fail and rate a hazard to the operator.

PERSONAL SAFETY

- **Stay alert,** watch what you are doing and use common sense when operating a power tool. Do not use tool while tired or under the influence of drugs, alcohol, or medication. A moment of inattention while operating power tools may result in serious personal injury.
- **Use safety equipment.** Always wear eye protection. Safety equipment such as dust mask, non-skid safety shoes, hard hat, or hearing protection for appropriate conditions will reduce personal injuries.
- **Dress properly.** Do not wear loose clothing or jewelry. Keep your hair, clothing and gloves away from moving parts. Loose clothes, jewelry or long hair can be caught in moving parts. Air vents may cover moving parts and should be avoided.

- **Avoid accidental starting.** Ensure the switch is in the off position before plugging in. Carrying power tools with your finger on the switch or plugging in power tools that have the switch on invites accidents.
- **Remove any adjusting keys or wrenches before turning the power tool on.** A wrench or key that is left attached to a rotating part of the tool may result in personal injury.
- **Do not overreach.** Maintain proper footing and balance at all times. Loss of balance can cause an injury in an unexpected situation.
- **If devices are provided for connection of dust extraction and collection facilities, ensure these are connected and properly used.** Use of these devices can reduce dust related hazards.
- **Do not use a ladder or unstable support.** Stable footing on a solid surface enables better control of the tool in unexpected situations.
- **Keep tool handles dry, clean and free from oil and grease.** Slippery handles cannot safely control the tool.

TOOL USE AND CARE

- **Secure the work piece.** Use clamp or other practical way to hold the work piece to a stable platform. Holding the work piece by hand or against your body is unstable and may lead to loss of control.
- **Do not force the power tool.** The tool will perform the job better and safer at the feed rate for which it is designed. Forcing the tool could possibly damage the tool and may result in personal injury.
- **Use the correct power tool for the job.** Don't force the tool or attachment to do a job for which it is not designed.
- **Do not use a tool if the switch does not turn it on or off.** Any tool that cannot be controlled with the switch is dangerous and must be repaired or replaced by an authorized service center.
- **Turn the power tool off, and disconnect the plug** from the power source and/ or battery pack from the power tool before making any adjustments, changing the accessories, or storing the tools. Such preventive safety measures reduce the risk of an accidental start up which may cause personal injury.
- **Store idle tool out of reach of children and other inexperienced persons.** It is dangerous in the hand of untrained users.
- **Maintain power tools with care.** Check for proper alignment and binding of moving parts, components, and any other conditions that may affect the tool's operation. A guard or any other part that is damaged must be properly repaired or replaced by an authorized service center to avoid risk of personal injury.
- **Use recommended accessories.** Using accessories and attachments not recommended by the manufacturer or intended for use on this type tool may cause damage to the tool or result in personal injury to the user. Consult the operator's manual for recommended accessories.
- **Keep cutting tools sharp and clean.** Properly maintained cutting tools with sharp cutting edges are less likely to bind and are easier to control.

- **Feed the work piece in the correct direction and speed.** Feed the work piece into a blade, cutter, or abrasive surface against the direction of the cutting tool's direction of rotation only. Incorrectly feeding the work piece in the same direction may cause the work piece to be thrown out at high speed.
- **Never leave the tool running unattended, turn the power off.** Do not leave the tool until it comes to a complete stop.
- **Never start the power tool when any rotating component is in contact with the work piece.**

SERVICE

- **Have Your Power Tool Serviced by a qualified repair person using only identical replacement parts.** This will ensure that the safety of the power tool is maintained.
- **Service Your Power Tool periodically.** When cleaning a tool, be careful not to disassemble any portion of the tool since internal wires may be misplaced or pinched.

WARNING:

READ AND UNDERSTAND ALL WARNINGS, CAUTIONS AND OPERATING INSTRUCTIONS BEFORE USING THIS EQUIPMENT. Failure to follow all instructions listed below may result in electric shock, fire and/or serious personal injury.

EXTENSION CORDS

Grounded tools require a three wire extension cord. Double insulated tools can use either a two or three wire extension cord. As the distance from the power supply outlet increases, you must use a heavier gauge extension cord. Using extension cords with inadequately sized wire causes a serious drop in voltage, resulting in loss of power and possible tool damage. Refer to the table shown below to determine the required minimum wire size.

The smaller the gauge number of the wire, the greater the capacity of the cord. For example: a 14-gauge cord can carry a higher current than a 16-gauge cord. When using more than one extension cord to make up the total length, be sure each cord contains at least the minimum wire size required. If you are using one extension cord for more than one tool, add the nameplate amperes and use the sum to determine the required minimum wire size.

Guidelines for Using Extension Cords

- If you are using an extension cord outdoors, be sure it is marked with the suffix "W-A" ("W" in Canada) to indicate that it is acceptable for outdoor use.
- Be sure your extension cord is properly wired and in good electrical condition. Always replace a damaged extension cord or have it repaired by a qualified person before using it.
- Protect your extension cords from sharp objects, excessive heat, and damp or wet areas.

Recommended Minimum Wire Gauge for Extension Cords (120 Volt)

Nameplate Amperes (At Full Load)	Extension Cord Length					
	25 Feet	50 Feet	75 Feet	100 Feet	150 Feet	200 Feet
0-2.0	18	18	18	18	16	16
2.1-3.4	18	18	18	16	14	14
3.5-5.0	18	18	16	14	12	12
5.1-7.0	18	16	14	12	12	10
7.1-12.0	18	14	12	10	8	8
12.1-16.0	14	12	10	10	8	6
16.1-20.0	12	10	8	8	6	6

SPECIFIC SAFETY RULES FOR BENCH GRINDERS

⚠ WARNING: DO NOT LET COMFORT OR FAMILIARITY WITH PRODUCT (GAINED FROM REPEATED USE) REPLACE STRICT ADHERENCE TO PRODUCT SAFETY RULES. If you use this tool unsafely or incorrectly, you can suffer serious personal injury!

- **Make sure the bench grinder is on a firm, level surface and properly secured** to avoid injury from unexpected movement. Firmly clamp or bolt the bench grinder to a support surface to prevent slipping or sliding during the operation.
- **Unplug the tool before making adjustments, repairs, maintenance or storing.**
- **Always switch off the tool before unplugging it** to avoid accidental starting when replugging the tool into a power source.
- **Wear eye protection. Do not wear gloves, necktie, or loose clothing.**
- **Do not operate the bench grinder** until it is assembled and installed according to this manual's instructions.
- **Always make sure the wheel guards and eye shields** are in place, properly adjusted and secured in place.
- **Use only attachments rated for 3600 RPM or higher** with a 1/2" arbor hole or appropriate sized bushing. Never use an attachment rated lower than 3600 RPM or attempt to machine an undersized wheel to fit the arbor.
- **Always use the wheel flanges furnished with this tool** to mount grinding wheels on the grinder shafts.
- **Do not overtighten the wheel nut.** Excessive tightening can cause the wheel to crack prior to or during operation.
- **Inspect grinding wheels before starting the machine** for visible defects such as fissures, cracks or chips. Replace damaged grinding wheels immediately.
- **Keep the spark guards close to the wheel and readjust them as the wheel wears.**
- **Adjust tool rest distance from the grinding wheel** to maintain a separation of 1/8" or less as the wheel diameter decreases from use.
- **Do not use a grinding wheel that vibrates when used.** If dressing the wheel does not solve the vibration, replace it. Also inspect the machine for other causes of vibration such as worn bearings or bent shaft. Repair or replace broken components immediately before reusing the machine.
- **Do not use the machine** if the switch does not turn it on and off. Defective switches should be immediately replaced by an authorized service center and the machine not used under repairs are completed.
- **Do not rapidly turn the machine on and off.** This action can cause the wheel to loosen and create a possible hazard.

- **Do not stand directly in front of the machine when turning it "ON".** Always stand off to the side of the machine and do not allow any part of your body to be in line with the path of the wheel.
- **Never grind on a cold wheel.** The grinder should always be started and allowed to run at idle speed for on full minute before applying work to the grinding wheel.
- **Never grind on the side of the wheel.** Always grind on the face of the wheel only.
- **Never apply coolant directly to the grinding wheel.** Coolant may weaken the bonding strength of the wheel causing it to fail. Dip the hot work piece into water to cool it.
- **Never start the grinder** with the work piece pressed against the grinding wheel or other attachments (wire brushes, buffing wheels, etc.)
- **Always ease the work piece against the wheel** when starting to grind. Use light pressure when applying the work piece to the grinding wheel. Excessive pressure can cause the wheel to crack or overload the motor.
- **Avoid awkward operations and hand positions** where an unexpected or sudden slip that could cause your hand or fingers to move into the grinding wheel, wire brush, buffing wheel, etc.
- **Always keep hands and fingers away from rotating attachments.**
- **Always hold the work piece firmly against the tool rest.** Be sure the tool rest is securely tightened in place to prevent movement during use.
- **Do not grind magnesium or aluminum,** fire may result.
- **Grinding creates hazardous sparks, never operate the grinder** near flammable gas, liquids, or in an explosive atmosphere.
- **Dress the grinding wheel face only.** Dressing the wheel sides can cause it to become too thin for safe use.
- **If any part of the grinder is missing, damaged or fails in any way,** or should any electrical component fail to perform properly, shut off the switch. Remove the machine plug from the power source and have damaged, missing, or failed parts replaced before resuming operation.
- **Clean the grinding dust from beneath the grinder frequently**
- **Do not operate in rain or in damp locations.**
- **Grounding required.**

SAVE THESE INSTRUCTIONS

YOUR 6" BENCH GRINDER

English

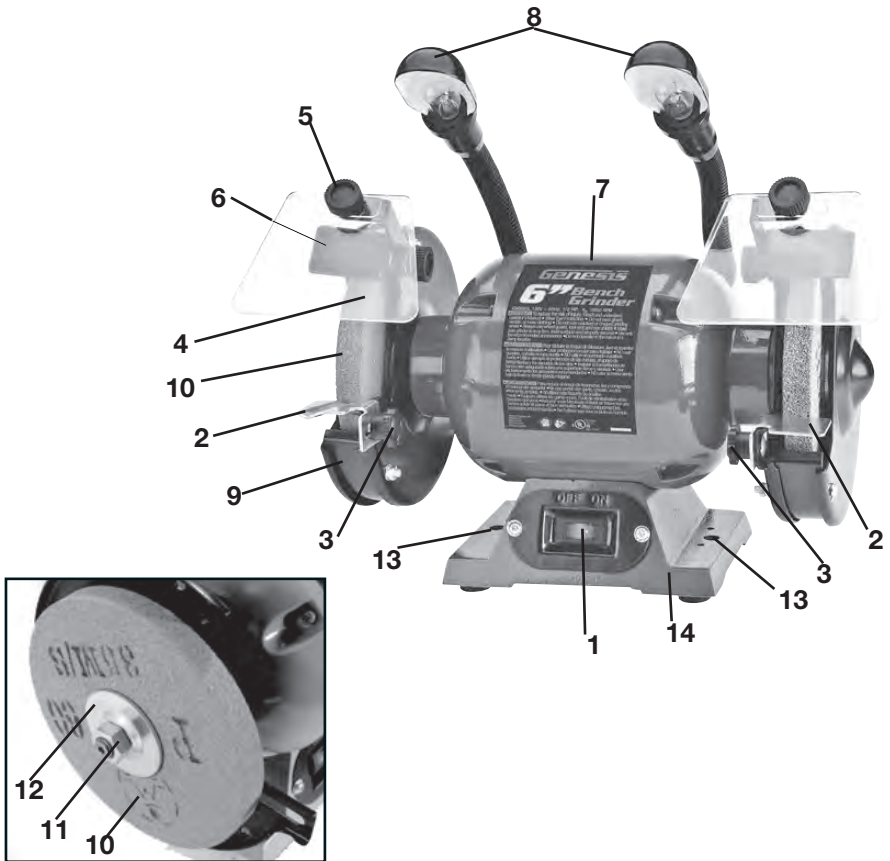

FIG 1

1. ON/OFF Switch
2. Tool Rest
3. Tool Rest Locking Knob
4. Eye Shield
5. Eye Shield Locking knob
6. Spark Guard
7. Motor
8. Work Lights
9. Wheel Guard
10. Grinding Wheel
11. Grinding Wheel Locking Nut
12. Grinding Wheel Outer Flange
13. Mounting Holes
14. Base

UNPACKING AND CONTENT

IMPORTANT: Due to modern mass production techniques, it is unlikely the tool is faulty or that a part is missing. If you find anything wrong, do not operate the tool until the parts have been replaced or the fault has been rectified. Failure to do so could result in serious personal injury.

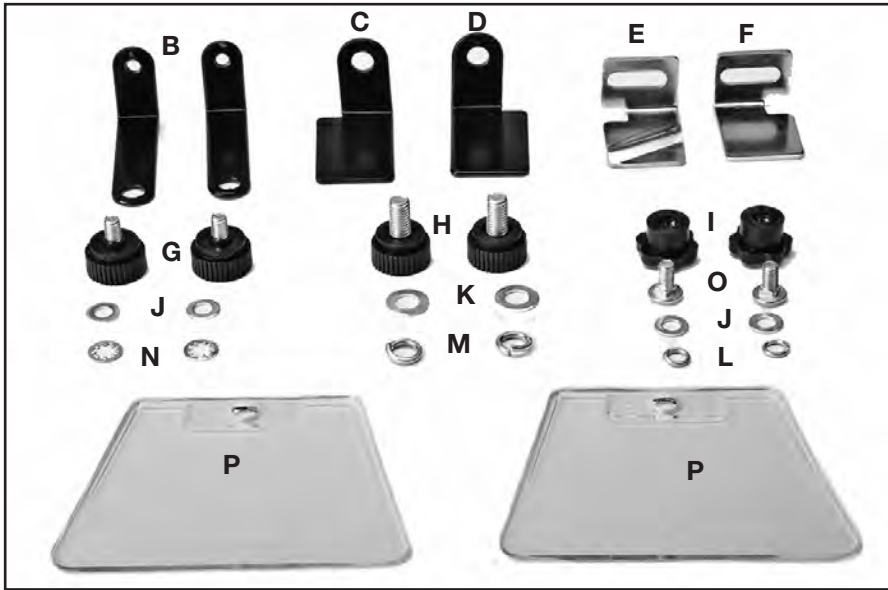

FIG 2

Contents in Package: (FIG 2)

Item	Description	QTY	Item	Description	QTY
A	Bench Grinder	1	J	Small Flat Washers	4
B	Eye Shield Brackets	2	K	Big Flat Washers	2
C	Left Spark Guard	1	L	Small Lock Washers	2
D	Right Spark Guard	1	M	Big Lock Washers	2
E	Left Tool Rest	1	N	Star Lock Washers	2
F	Right Tool Rest	1	O	Tool Rest Bolts	2
G	Eye Shield Locking Knobs	2	P	Eye Shields	2
H	Bracket Locking Knobs	2	Q	Operator's Manual (not shown)	
I	Tool Rest Locking Knobs	2			

⚠ WARNING: If any parts are missing or damaged, do not attempt to assemble the tool, plug in power cord or turn the switch on until the missing or damaged parts are replaced.

ASSEMBLY AND ADJUSTMENTS

⚠ WARNING: Always be sure that the tool is switched off and unplugged from the power source before adjusting, adding accessories, or checking a function on the tool.

Attaching and Adjusting Spark Guards and Eye Shields (FIG 3,4)

NOTE: Always check to ensure the eye shields are correctly attached and the spark guards are correctly adjusted each time the grinder is used. Eye shields and spark guards must be attached over each grinding wheel.

There is a left and a right spark guard. Consult FIG 3 to properly determine the mounting position of each spark guard. Follow the steps to attach the Spark Guard and Eye Shield on the LEFT side of the grinder.

1. Insert Bracket Locking Knob (H) through a big lock washer (M), a big flat washer (K), the eye shield bracket (B) and the LEFT spark guard (C), then screw into the hole in the left wheel guard. Tighten sufficiently to hold the spark guard and the eye shield bracket in place. (See FIG 3)
2. Adjust the spark guard to make its lower edge about 1/8" (3.2 mm) away from the grinding wheel face. Rotate the wheel by hand one revolution to ensure the wheel can rotate without contacting with the spark guard. Firmly tighten the locking knob (H) to secure the spark guard and eye shield bracket onto the wheel guard.
3. Insert the shield locking knob (G) through a star washer (N) and a small flat washer (J) and the eye shield (P), and then screw and tighten securely onto the eye shield bracket (B) (see FIG 4)

Repeat the above steps to attach the RIGHT spark guard and the eye shield on the right side of the grinder.

Attaching and Adjusting Tool Rests (FIG 5,6)

The tool rests are required for each high speed grinding wheel to assist in the grinding operation.

⚠ WARNING: Never use a bench grinder on which tool rest has not been attached or where the tool rest has not been correctly adjusted.

NOTE: There is a left and a right tool rest. The tool rest with v-groove (E) is the left side tool rest (See FIG 5). When properly mounted with the slotted portion of the tool rest bolted flush to the tool rest bracket, the tool rest will be positioned directly in front of the grinding wheel.

1. Hold the LEFT tool rest (E) in the correct position against the tool rest bracket (2) on left wheel guard (see FIG 6).
2. Insert tool rest bolt (O) through tool rest bracket (2) and tool rest (E), followed by a small flat washer (J), a small lock washer (L), and the tool rest locking knob (I).
3. Tighten the locking knob (I) sufficiently to support the tool rest but still allowing the tool rest to slide inwards and outwards.

FIG 3

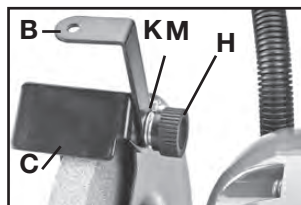

FIG 4

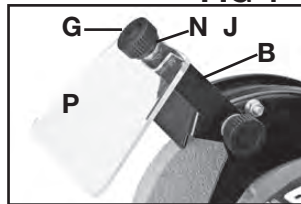

FIG 5

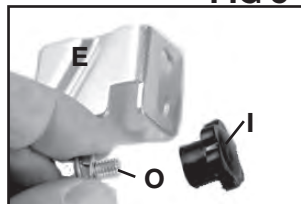
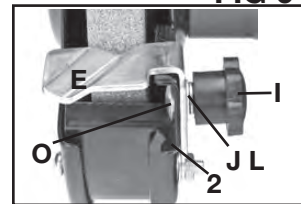

FIG 6



- Slide the tool rest to within a maximum of 1/16" (1.5 mm) from the wheel. Rotate the wheel one full revolution by hand to ensure the wheel does not contact the tool rest.
- Tighten the locking knob firmly to retain the assembly.
- Repeat the assembly operation for the RIGHT tool rest.

Mounting Bench Grinder

If during operation of the bench grinder there is any tendency for the grinder to slide or "walk" or to tip over, then the grinder must be secured to a work bench or other supporting surface using fasteners (not supplied) through the two holes in the grinder base.

Before mounting the grinder to a work bench or similar surface, determine the ideal mounting position by performing a series of non-powered tests with items that will typically be used on the grinder (e.g. lawn mower blades, scissors, knives, wood chisels, wood turning tools, etc.) These tests runs will help determine how near the work bench edge the grinder should be mounted so that the bench top does not interfere with grinding operations. Be sure the work bench or pedestal to which the bench grinder will be mounted is flat, level, and sturdy enough to bear the weight of the grinder, other tools, and the material being worked.

Changing the Grinding Wheels (FIG 7)

⚠ WARNING: Use only grinding wheels rated for 3,600 rpm or higher with a 1/2" arbor hole or appropriate sized bushing. Never use a grinding wheel rated lower than 3,600 rpm or attempt to machine an undersized wheel to fit the arbor.

- Remove the three bolts (1) attaching the protective side cover (2) to the grinder; then remove the side cover.
- Prevent the shaft from rotating by placing a wedge between the wheel and the tool rest.
- Facing the front of the bench grinder: to replace the wheel on the left side, turn the arbor nut (3) clockwise to loosen and counterclockwise to tighten the arbor nut.
- To replace the wheel on the right: turn counterclockwise to loosen and clockwise to tighten.

NOTE: Many grinding wheels use removable and adjustable arbor bushings to allow adaptation to various machine arbor diameters. Save this bushing for future use if not needed to install the replacement wheel.

- Remove the arbor nut (3), outer flange (4) and the old wheel.
- Install the replacement wheel and outer flange on the shaft. Make sure the wheel is slide fit (not loose) on the shaft.
- Replace the arbor nut and tighten.
- Replace the side cover. Reinsert the three bolts and tighten the side cover in place.
- Re-adjust tool rest, spark guard and eye shield.
- Rotate the wheel by hand to check free movement and proper adjustments.

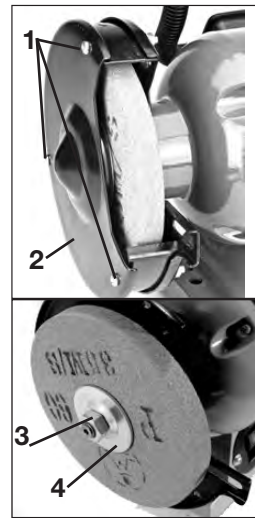

FIG 7

⚠ WARNING: Do not overtighten wheel nuts when installing grinding wheels. Tighten the wheel nut enough to drive the wheel and prevent slippage.

OPERATION

IMPORTANT: Before each use of the bench grinder, inspect its general condition. Check for loose screws, damaged electrical wiring, cracked, chipped, or damaged wheels and misalignment or binding of the moving parts. If bench or pedestal mounted, check that all fasteners are in place and tight.

CAUTION: Keep your bench grinder clean by removing dust from working parts, the lower portion of the wheel guard assembly, and the work area surrounding the grinder.

ON/OFF Switch (FIG 8)

The Switch (1) is located on the front of the grinder.

To turn the grinder "ON", push the right hand portion of the switch, with the white dot, down.

To turn the grinder "OFF", push the left hand portion of the switch down.



FIG 8

Work Light

Your grinder is equipped with two flexible work lights for better visibility in the work area during operation. When the tool is turned on, the lights will turn on automatically and stay on until the tool is turned off.

⚠ WARNING: Always be sure that the tool is switched off and unplugged from the power source before adjusting, adding accessories, or checking a function on the tool.

Grinding Wheels

For best grinding results and maintaining good balance, always keep the wheel(s) properly dressed. Never force a work piece against a cold wheel but use light pressure until the wheel becomes warm. We strongly recommend using only balanced wheels on these grinders. Balanced wheels will add years of life to grinder bearings and arbor shaft, and eliminate the most common cause of vibration, which will yield more accurate work.

Dressing a Grinding Wheel

When the grinding wheel is out of balance, worn out of shape, or dull, loaded and glazed, it must be trued and dressed. Truing or dressing the wheel is best done using a "star-wheel" dresser, silicone carbide stick type dresser or a diamond faced dressing tool (not supplied). Dress the wheel by moving the dresser forward on the tool rest until it just touches the highpoint on the face of the wheel, then dress the wheel by moving the dresser back and forth across the wheel face. Repeat this procedure until the face of the grinding wheel is clean and the corners of the wheels are square.

BASIC GRINDER OPERATIONS

⚠ WARNING: Always wear safety goggles or safety glasses with side shields during operation of any power tool. If the operation is dusty, wear appropriate protective mask.

Your Bench Grinder is equipped with one coarse grinding wheel and one medium grinding wheel. It is the ideal tool for sharpening tools such as wood chisels, cold chisels, planer blades, scissors, lawn mower blades, etc.

⚠ WARNING: Never sharpen or grind anything made of or containing aluminum or magnesium.

Because grinders can remove material rapidly, a freshly dressed wheel and the amount of work piece pressure applied to the wheel are keys to efficient grinding. Use the following basic guidelines to aid in working metals and avoid overheating:

- **Never** force the work piece against the grinding wheel.
- **Always** keep the work piece constantly moving against the grinding wheel with light pressure and even motion.
- **Keep** the work piece cool by maintaining a container of water nearby for dipping the work piece.
- **Always** use the face of the grinding wheel with the wheel moving downward, into the object being worked.
- **Do not** perform grinding operations on the side of the wheel.

Lawn Mower Blades

As you prepare to sharpen the lawn mower blade, ensure there is adequate working space to maneuver the blade. Lawn mower blades are generally sharpened on the beveled side and then dressed up slightly on the other side with the grinder or file.

First remove any nicks that may be present on the cutting edge by resting the blade flat on the tool rest, moving the blade side to side until the edge is nick free. To sharpen the bevel, either adjust the tool rest angle to match the blade's bevel angle or hold the blade at the bevel angle while resting a portion of the blade on the tool rest for added stability. Use a light touch, removing as little metal as possible to attain the desired edge; then lightly dress-up the flat backside of the blade. Ideally, lawn mower blades should not be honed to razor like sharpness; this increases the likelihood of nicking and promotes rapid dulling. Use a file or the bench grinder to lightly face the cutting edge.

After the blade has been sharpened, be sure to check the blade's balance with an appropriate shop made jig or commercially available unit. Balance the blade by progressively removing metal until balance is attained.

⚠ WARNING: An unbalanced lawn mower blade may cause excessive vibration, causing damage to the mower and engine shaft.

Sharpening Twist Drill Bits:

Sharpening twist drills can be a tricky operation that even some experienced mechanics never master. Sharpening twist bits freehand will require considerable practice and dry runs with the grinder "OFF" to acquire the skill of rotating the bit while maintaining the original cutting edge angle. If you anticipate sharpening numerous bits consider purchasing a specialized sharpening jig, available at most hardware and home centers. A typical technique for sharpening a twist drill bit is as follows:

1. Set the grooved tool rest horizontal to the face of the grinding wheel.
2. Hold the drill shank between the thumb and index finger, resting the back of the index finger on the tool rest.
3. Be sure that the cutting lip is straight across the face of the wheel before beginning each stroke
4. When the drill contacts the wheel, push the drill shank downward and to the left at a slight angle. At the same time, rotate the drill so the other lip is just visible.
5. Repeat this process on the other lip to sharpen the entire twist drill.

Sharpening Wood Chisels & Plane Irons:

As in all freehand sharpening operations, practicing the technique and actual sharpening experience are the best teachers. Sharpening chisels and irons on the bench grinder will produce razor sharp hollow ground bevels which must be followed by honing on a whetstone. Use the following tips to help develop your sharpening skill and success.

1. The chisel cutting edge must be free of nicks and be 90° to the chisel edge. With the tool rest flat, lightly dress the cutting edge if nicks are present or it's out of square.
2. Adjust the tool rest angle to 25 - 30 degrees to the face of the grinding wheel. Rest the chisel on the angled tool rest and move it laterally across the face of the wheel.
3. Be sure to occasionally cool the tool in water to maintain its hardness.
4. Continue grinding the cutting edge and bevel until the length of the bevel is roughly twice the thickness of the chisel. Remove only the material necessary to achieve the desired bevel angle with a sharp and square cutting edge.
5. This process produces a sharp hollow ground bevel with a small amount of "wire" burr which will be removed by final honing on a whetstone.

Consult woodworking publications for additional tool sharpening information and examples of shop made jigs and fixtures and techniques to finely tune your chisels, plane irons, planer blades, etc.

Refurbishing Screwdriver Tips:

Screwdriver tips often get worn or bent out of shape and must be reshaped by grinding to perform properly.

1. Select a flat-head screw with a slot the same width as the screwdriver blade tip.
2. Grind screwdriver tip square and remove all gaps, nicks, and twists in the screwdriver blade. Apply only light pressure to the blade while moving it back and forth across the grinding wheel face.
3. Turn the screwdriver frequently to keep both sides parallel.
4. If ground correctly, the tip should fit completely into the screw slot with no visible gaps.

MAINTENANCE

CLEANING

Avoid using solvents when cleaning plastic parts. Most plastics are susceptible to damage from various types of commercial solvents and may be damaged by their use. Use clean cloths to remove dirt, dust, oil, grease, etc.

⚠ WARNING: Do not at any time let brake fluids, gasoline, petroleum-based products, penetrating oils, etc., come in contact with plastic parts. Chemicals can damage, weaken or destroy plastic which may result in serious personal injury.

Electric tools used on fiberglass material, wallboard, spackling compounds, or plaster are subject to accelerated wear and possible premature failure because the fiberglass chips and groundings are highly abrasive to bearings, brushes, commutators, etc. Consequently, we do not recommend using this tool for extended work on these types of materials. However, if you do work with any of these materials, it is extremely important to clean the tool using compressed air.

LUBRICATION

This tool is permanently lubricated at the factory and requires no additional lubrication.

TWO-YEAR WARRANTY

This product is warranted free from defects in material and workmanship for 2 years after date of purchase. This limited warranty does not cover normal wear and tear or damage from neglect or accident. The original purchaser is covered by this warranty and it is not transferable. Prior to returning your tool to store location of purchase, please call our Toll-Free Help Line for possible solutions. ***THIS PRODUCT IS NOT WARRANTED IF USED FOR INDUSTRIAL OR COMMERCIAL PURPOSES. ACCESSORIES INCLUDED ARE NOT COVERED BY THE 2 YEAR WARRANTY.***

TOLL-FREE HELP LINE

For questions about this or any other GENESIS Product,

Please call Toll-Free: **888-552-8665**. (Mon-Fri, 9:00 am to 4:30 pm EST.)

Or visit our web site: **www.richpowerinc.com**

Genesis

Richpower Industries, Inc.
736 Hampton Road
Williamston, SC USA
www.richpowerinc.com