



Vehicle Make/Model	Page	Vehicle Make/Model	Page
Acura: <i>See Honda</i>	24-26	Lamborghini: <i>See Volkswagen</i>	45-46
Alfa Romeo	6	Land Rover	32
AMC	6	Lexus: <i>See Toyota</i>	42-45
Audi: <i>See Volkswagen</i>	45-46	Lincoln: <i>See Ford</i>	10-14
BMW	6	Mack Truck	32
Buick: <i>See General Motors</i>	15-23	Mazda	33-36
Cadillac: <i>See General Motors</i>	15-23	Mercedes-Benz	36
Caterpillar	6	Mercury: <i>See Ford</i>	10-14
Chevrolet: <i>See General Motors</i>	15-23	Mitsubishi	36-37
Chrysler	7-9	Nissan	38-40
Clark Forklift	9	Oldsmobile: <i>See General Motors</i>	15-23
Club Car	9	Plymouth: <i>See Chrysler</i>	7-9
Daewoo	9	Pontiac: <i>See General Motors</i>	15-23
Datsun: <i>See Nissan</i>	38	Saab	40
Dodge, Eagle: <i>See Chrysler</i>	7-9	Saturn: <i>See General Motors</i>	15-23
E-Z Go Golf Cart	10	Subaru	40-41
Ferrari	10	Suzuki	41
Fiat	10	Suzuki Motorcycle	42
Ford	10-14	Triumph Motorcycle	42
Freightliner	14	Toyota	42-45
General Motors	15-23	Toyota Forklift	42
Geo, GMC: <i>See General Motors</i>	15-23	Volkswagen	45-46
Harley Davidson Motorcycle	24	Volvo	46
Hino Truck	24	Yamaha Motorcycle	47
Honda	24-26	Yard Tractor	48
Honda Motorcycle	26	Yugo	48
Hummer	27		
Hyundai	27-28		
Infiniti: <i>See Nissan</i>	38-40		
Isuzu	29-30		
Jeep: <i>See Chrysler</i>	7-9		
John Deere	30		
Kawasaki Motorcycle	31		
Kia	31		
Komatsu	32		
Kubota	32		



Automotive Keys

ACURA

ALFA ROMEO

AMC

See **HONDA**
Automotive
on pg 24

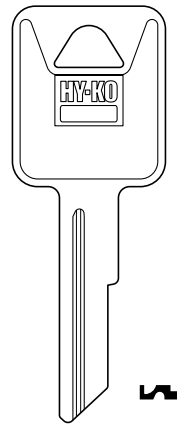
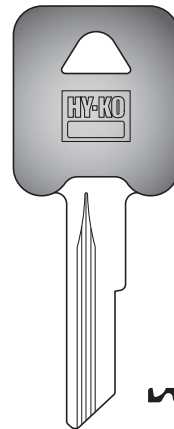
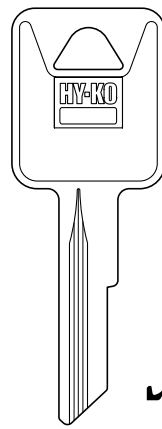
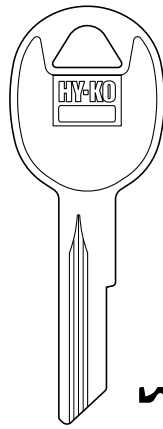
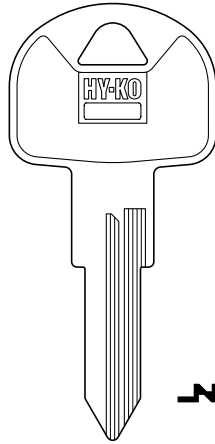

Hy-Ko EZ No.

FT46

RA3

RA4

RA4P

RA7

AUDI

BMW

See **VOLKSWAGEN**
Automotive
on pg 45

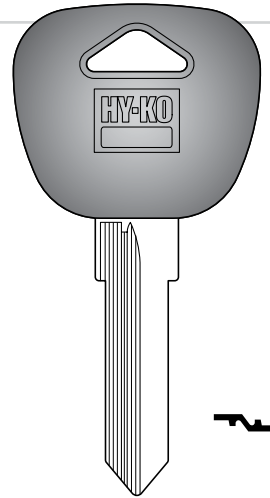
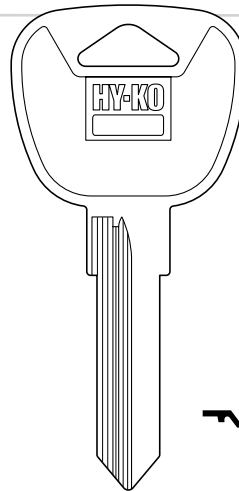
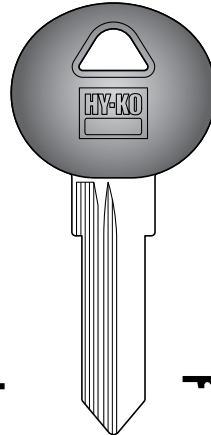
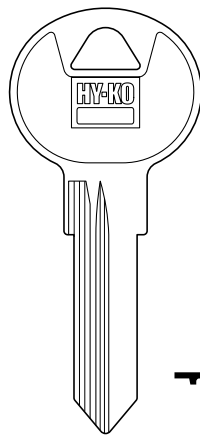

Hy-Ko EZ No.

BMW2

BMW2P

BMW3

BMW3P

BUICK, CADILLAC

CATERPILLAR

See **GENERAL MOTORS**
Automotive
on pg 15

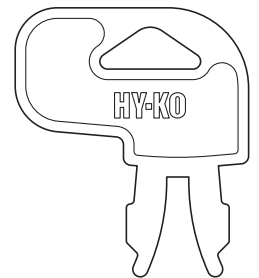
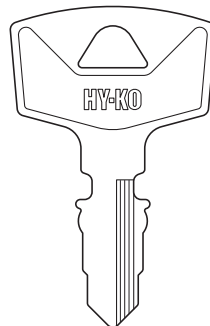
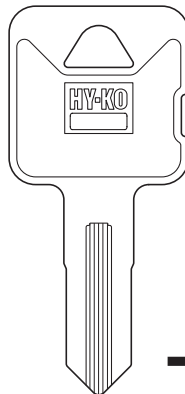

Hy-Ko EZ No.

CAT1

CAT2

CAT3

CNA2

Identifying A Key

1 Find a key similar in size, key head shape, and millings.

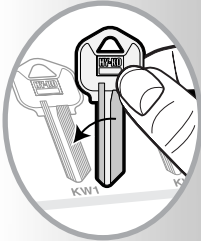

2 Raise key vertically on its tip and place on the key cross section.

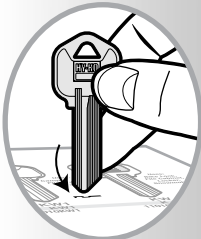

3 Match the grooves of the key to the keyway.

Automotive Keys

CHEVROLET

CHRYSLER (Includes Dodge, Eagle, Jeep, Plymouth)

See
GENERAL MOTORS
Automotive
on pg 15

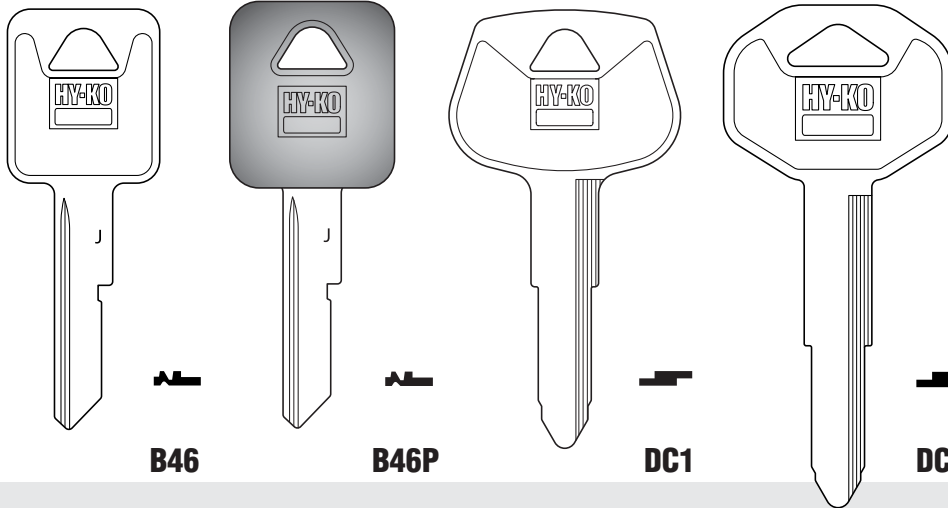

Hy-Ko EZ No.

B46

B46P

DC1

DC3

CHRYSLER

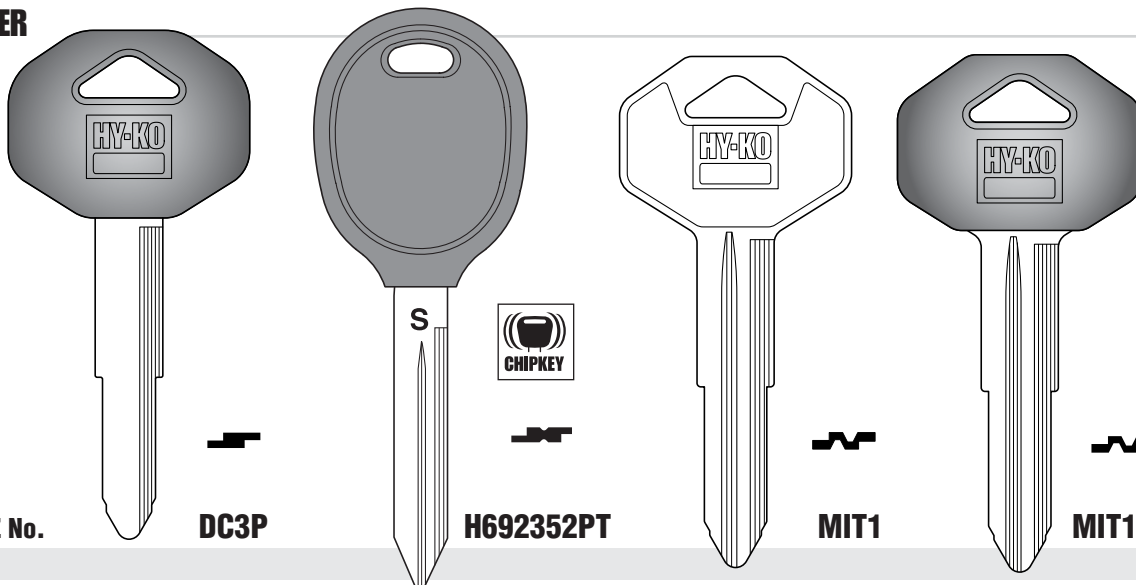

Hy-Ko EZ No.

DC3P

H692352PT

MIT1

MIT1P

CHRYSLER

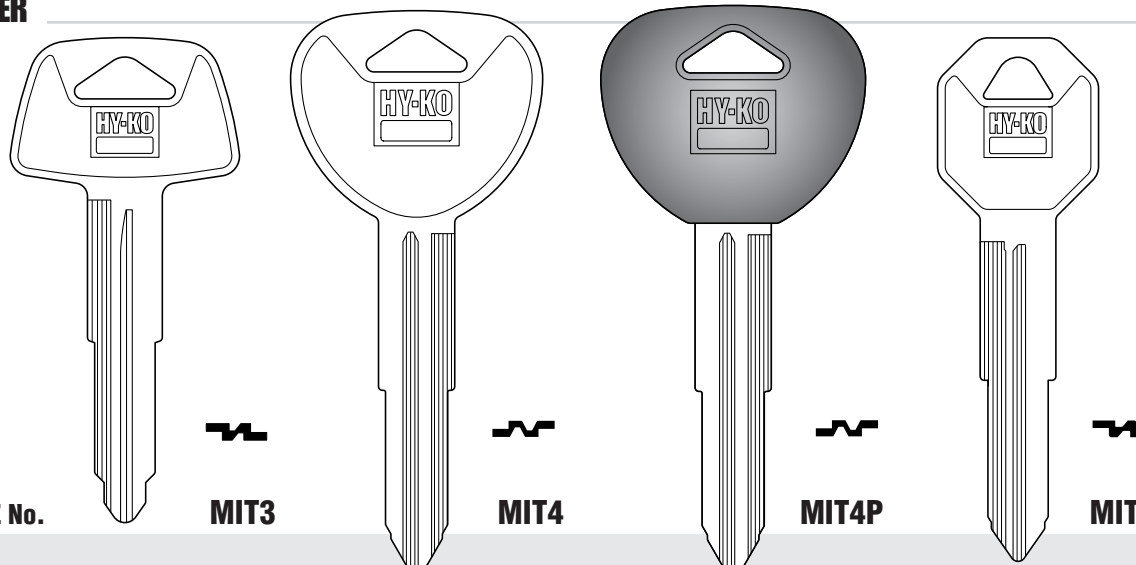

Hy-Ko EZ No.

MIT3

MIT4

MIT4P

MIT5

Finding A Key

1 Look for identification marks on the key head (bow).

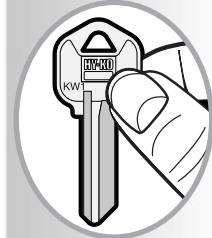

(i.e. manufacturer's name, key name, etc.)

2 Ask the customer how the key is used.

3 See reference sections:

- Key Cross Reference pp 76-92

P – Black plastic head
PC – Color plastic head
See page 4 for key name explanations.

Automotive Keys

CHRYSLER

Identifying A Key

1 Find a key similar in size, key head shape, and millings.

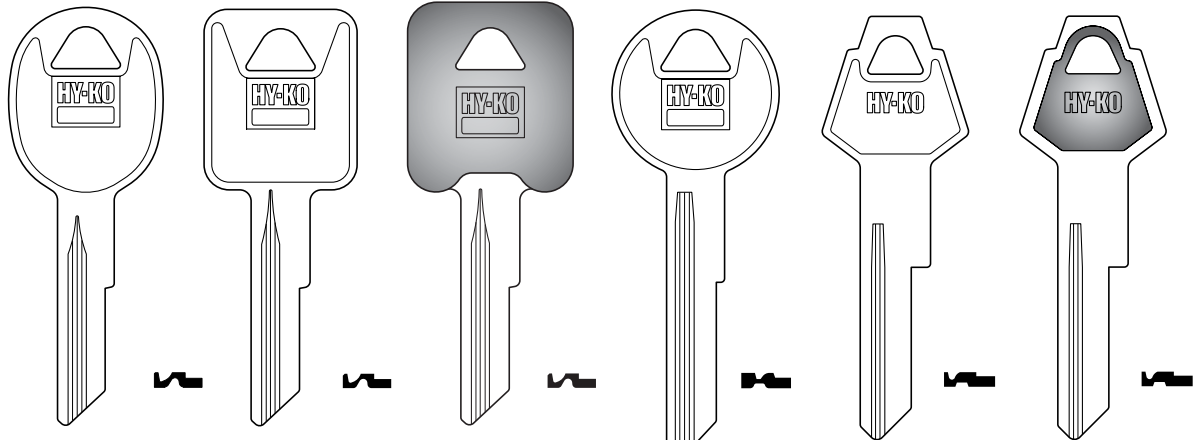

Hy-Ko EZ No. RA3 RA4 RA4P Y149 Y152 Y152PC

CHRYSLER

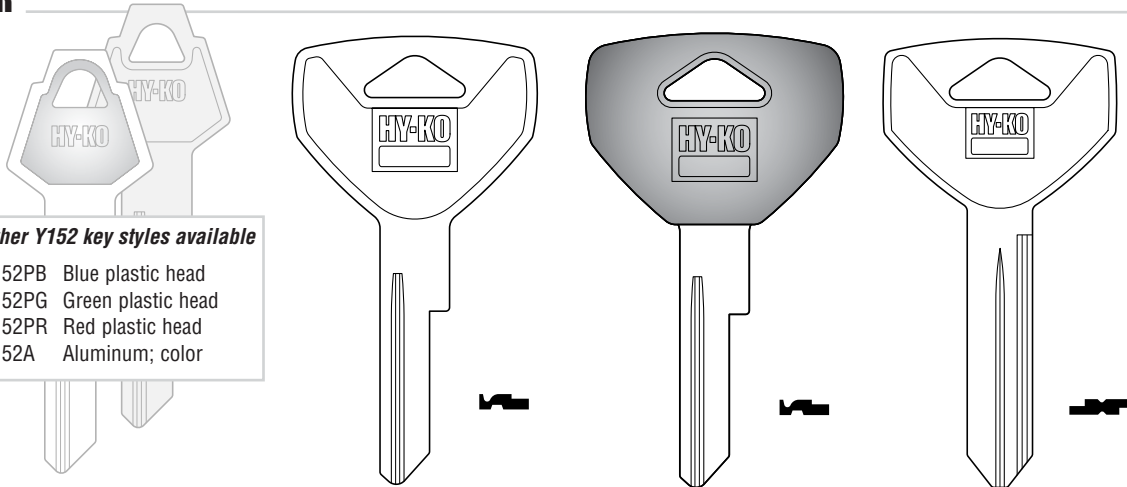

Other Y152 key styles available

- Y152PB Blue plastic head
- Y152PG Green plastic head
- Y152PR Red plastic head
- Y152A Aluminum; color

Hy-Ko EZ No. Y153 Y153P Y154

CHRYSLER

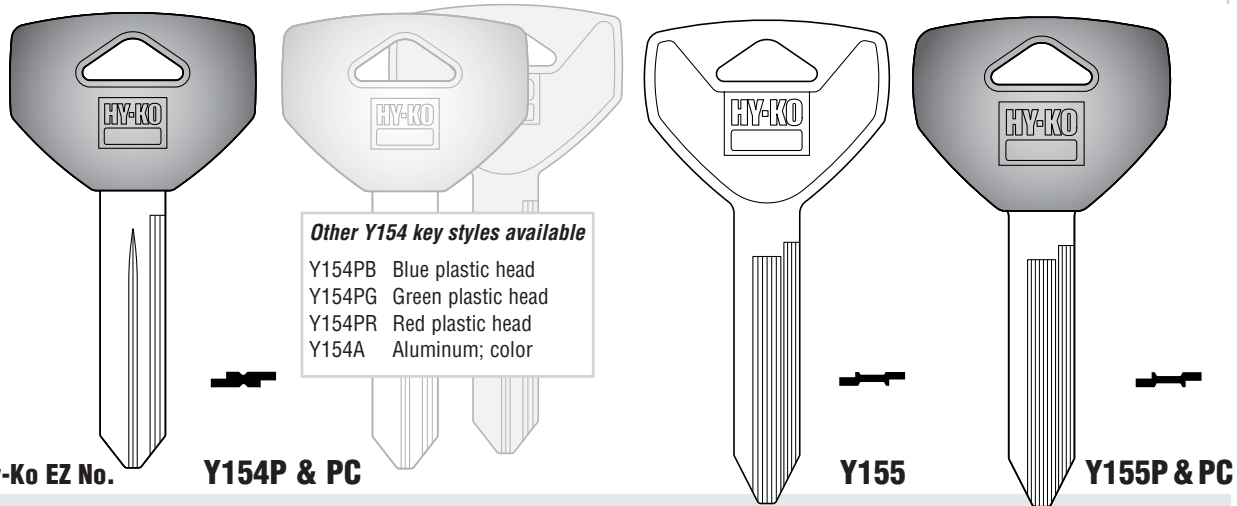

Other Y154 key styles available

- Y154PB Blue plastic head
- Y154PG Green plastic head
- Y154PR Red plastic head
- Y154A Aluminum; color

Hy-Ko EZ No. Y154P & PC Y155 Y155P & PC

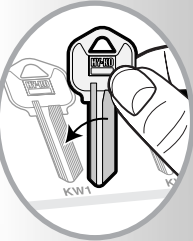

2 Raise key vertically on its tip and place on the key cross section.

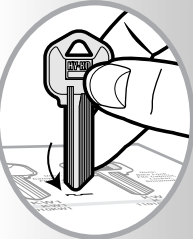

3 Match the grooves of the key to the keyway.

CHRYSLER

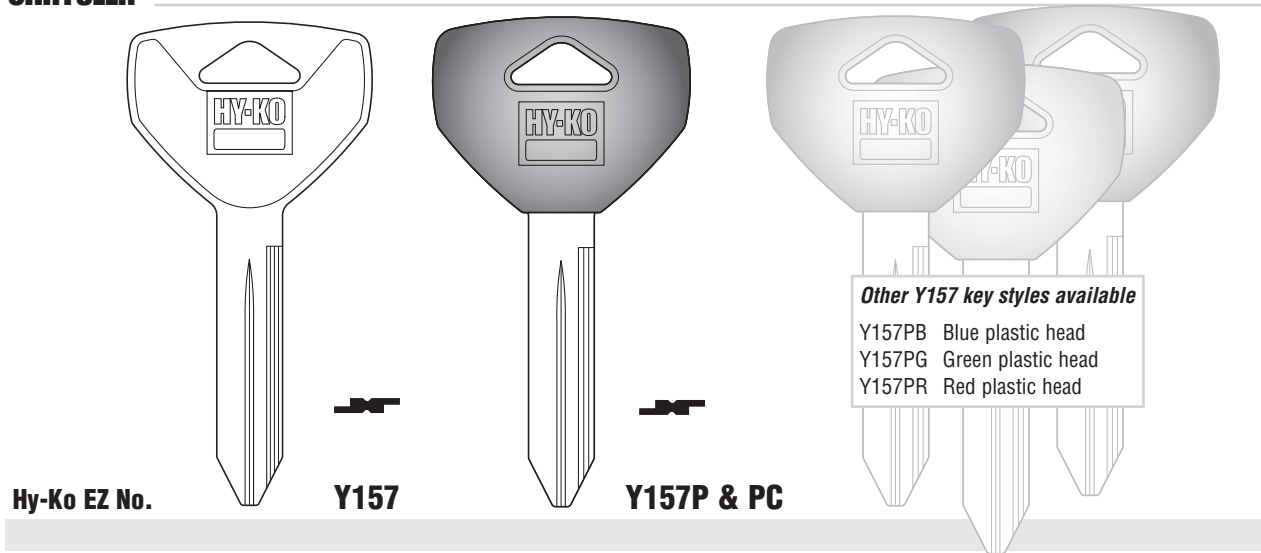

Hy-Ko EZ No.

Y157

Y157P & PC

Finding A Key

1 Look for identification marks on the key head (bow).

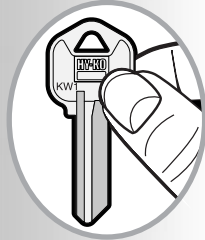

(i.e. manufacturer's name, key name, etc.)

2 Ask the customer how the key is used.

3 See reference sections:

• Key Cross Reference pp 76-92

CHRYSLER

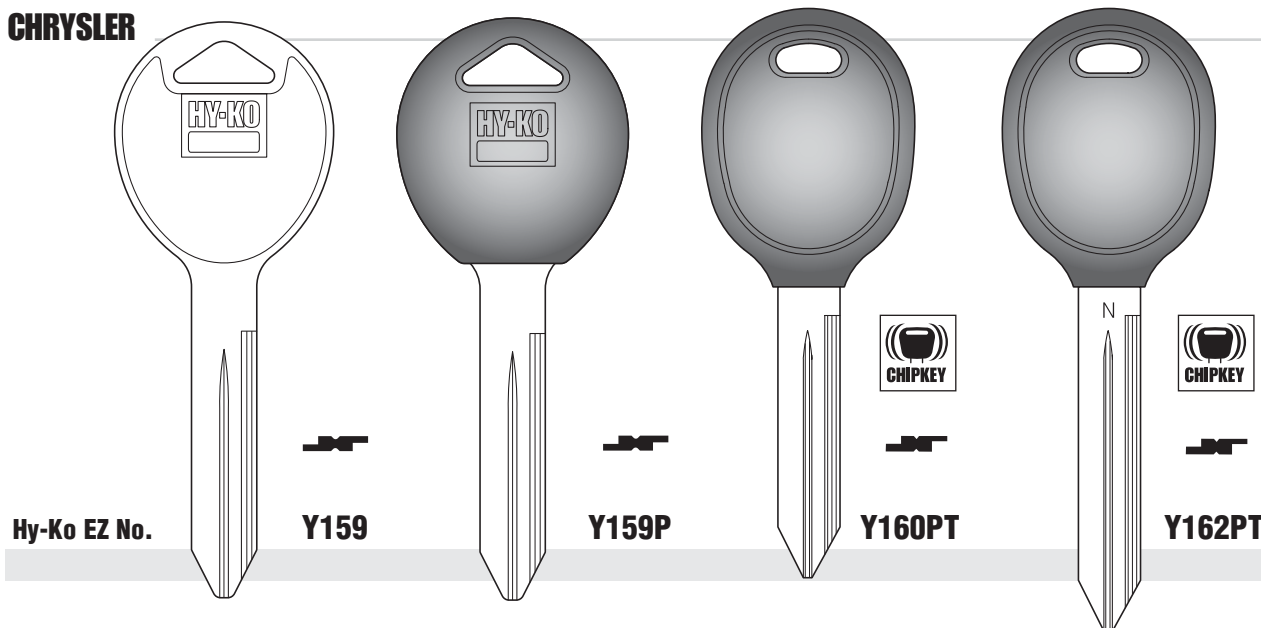

Hy-Ko EZ No.

Y159

Y159P

Y160PT

Y162PT

CLARK FORKLIFT

CLUB CAR

DAEWOO

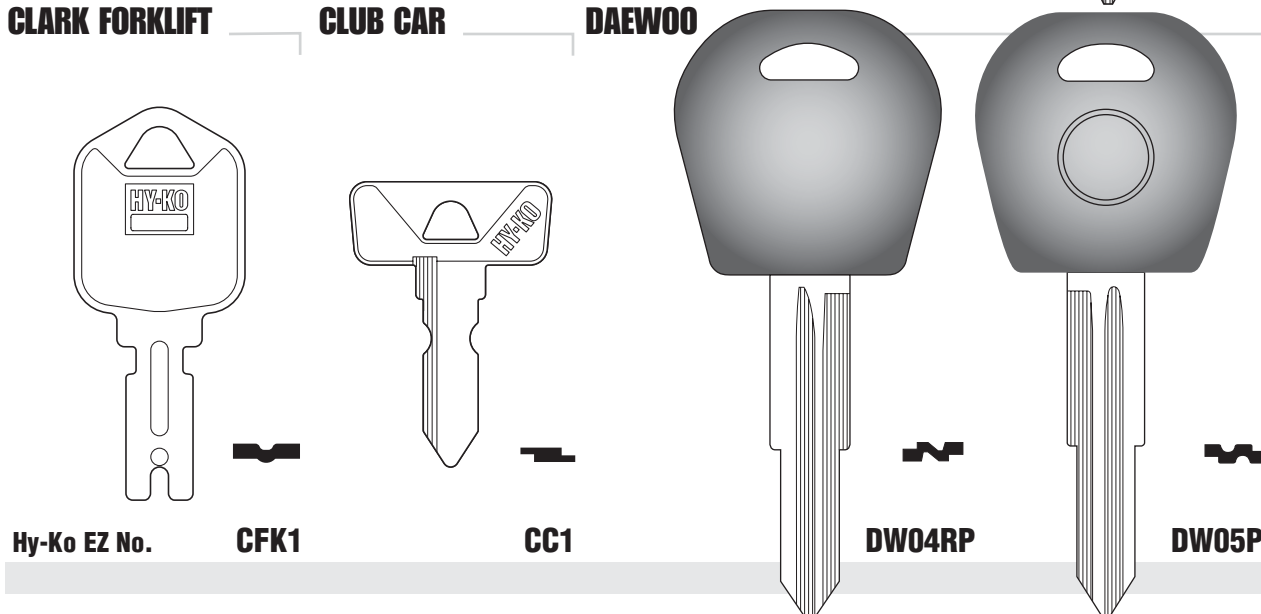

Hy-Ko EZ No.

CFK1

CC1

DW04RP

DW05P

P – Black plastic head
 PC – Color plastic head
 See page 4 for key name explanations

Automotive Keys

DATSUN

DODGE, EAGLE

E-Z GO GOLF CART

FERRARI

**See NISSAN
Automotive
on pg 38**

**See CHRYSLER
Automotive
on pg 7**

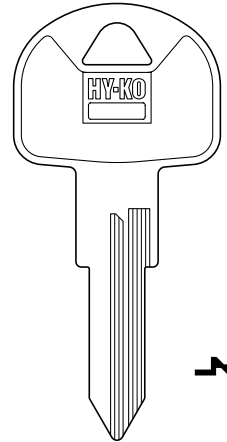
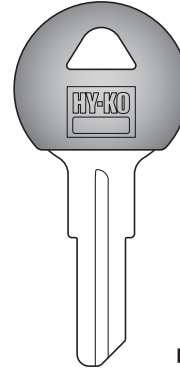
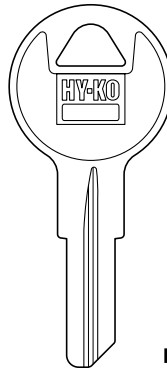

Hy-Ko EZ No.

B52

B52P

FT46

Identifying A Key

1 Find a key similar in size, key head shape, and millings.

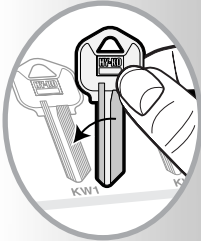

FIAT

FORD (Includes Lincoln, Mercury)

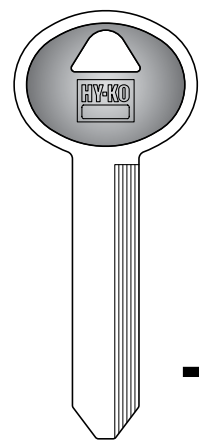
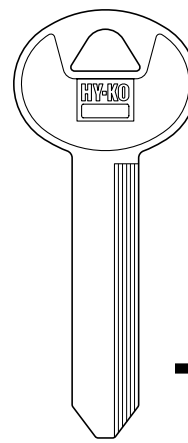
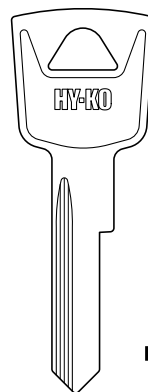
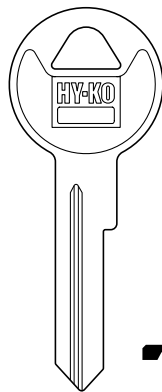
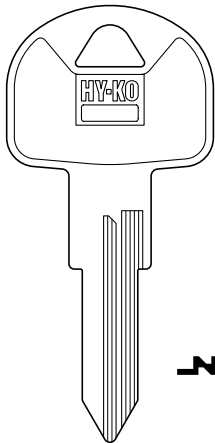

Hy-Ko EZ No.

FT46

H26

H27

H50

H50P & PC

2

Raise key vertically on its tip and place on the key cross section.

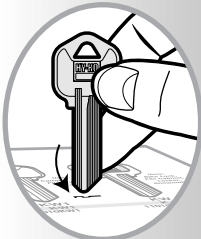

3

Match the grooves of the key to the keyway.

FORD

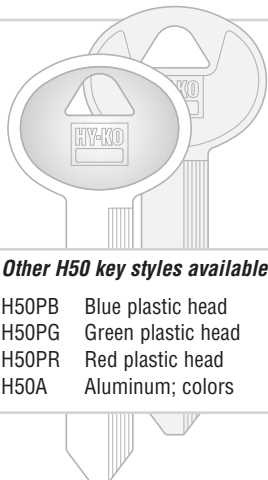

Other H50 key styles available

- H50PB Blue plastic head
- H50PG Green plastic head
- H50PR Red plastic head
- H50A Aluminum; colors

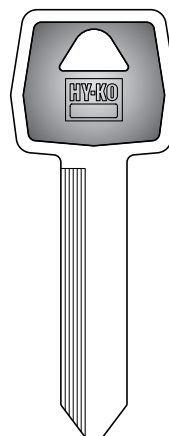
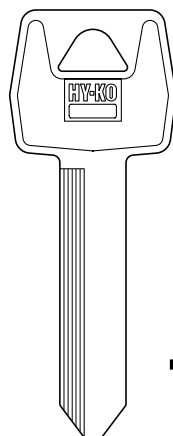

Other H51 key styles available

- H51A Aluminum; colors

Hy-Ko EZ No.

H51

H51P & PC

FORD

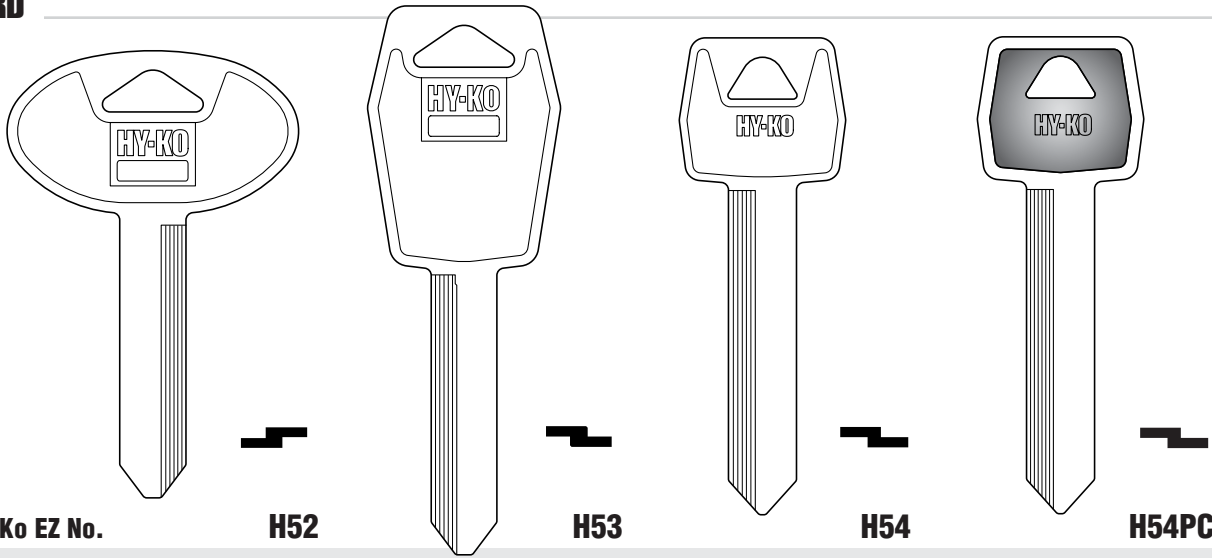

Hy-Ko EZ No.

H52

H53

H54

H54PC

FORD

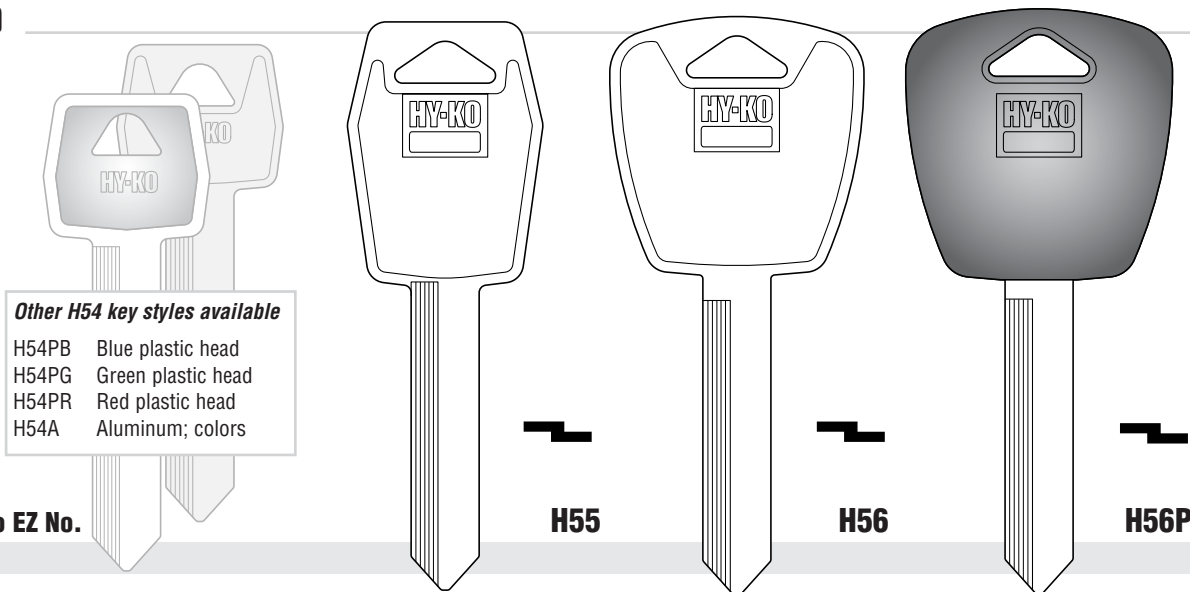

Other H54 key styles available
 H54PB Blue plastic head
 H54PG Green plastic head
 H54PR Red plastic head
 H54A Aluminum; colors

Hy-Ko EZ No.

H55

H56

H56P

FORD



Hy-Ko EZ No.

H59

H59P

Finding A Key

1 Look for identification marks on the key head (bow).

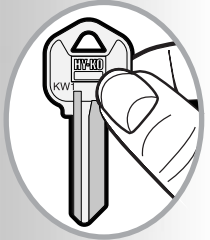

(i.e. manufacturer's name, key name, etc.)

2 Ask the customer how the key is used.

3 See reference sections:

- Key Cross Reference pp 76-92

P – Black plastic head
 PC – Color plastic head
 See page 4 for key name explanations

Automotive Keys

FORD

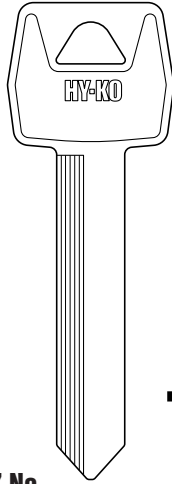

H60

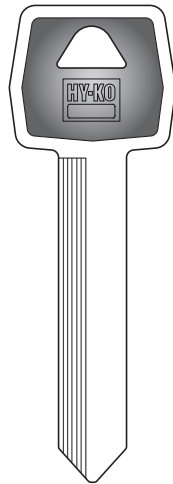

H60P

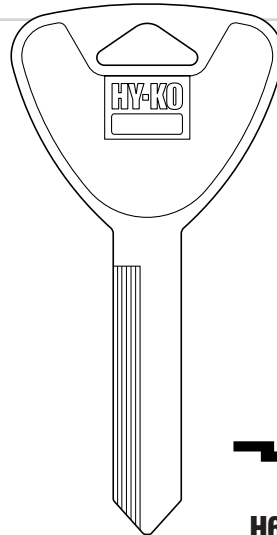

H62

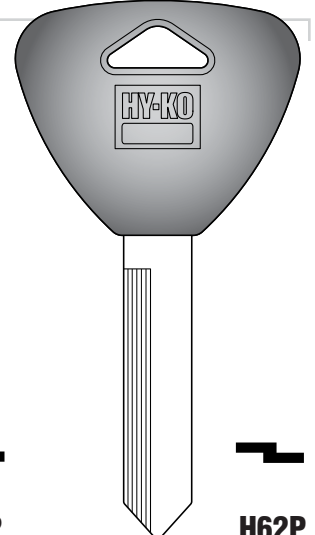

H62P

Identifying A Key

1 Find a key similar in size, key head shape, and millings.

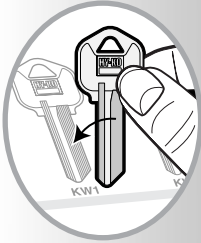

2 Raise key vertically on its tip and place on the key cross section.

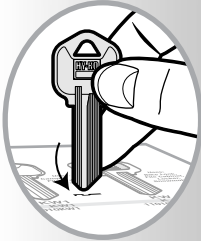

3 Match the grooves of the key to the keyway.

FORD

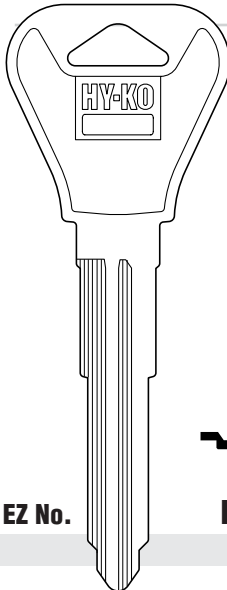

H65

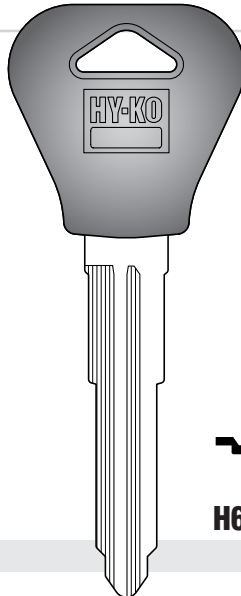

H65P

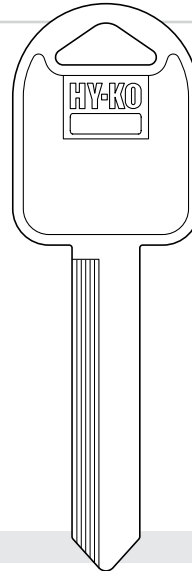

H66

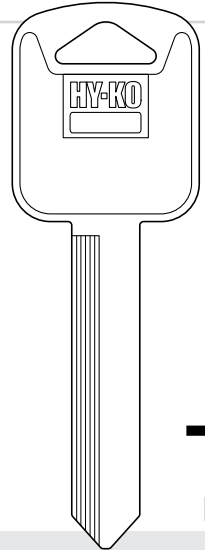

H67

FORD

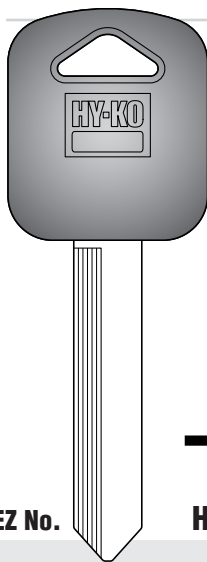

Hy-Ko EZ No.

H67P

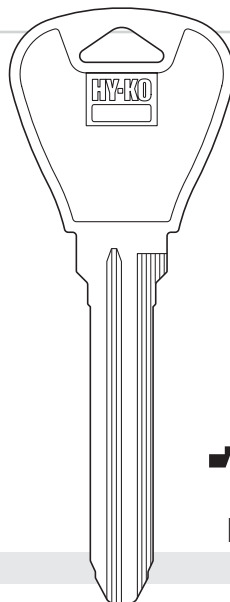

H70

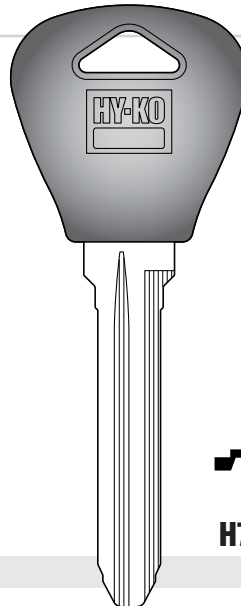

H70P

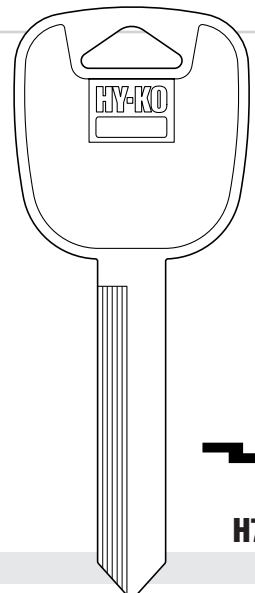

H71

FORD

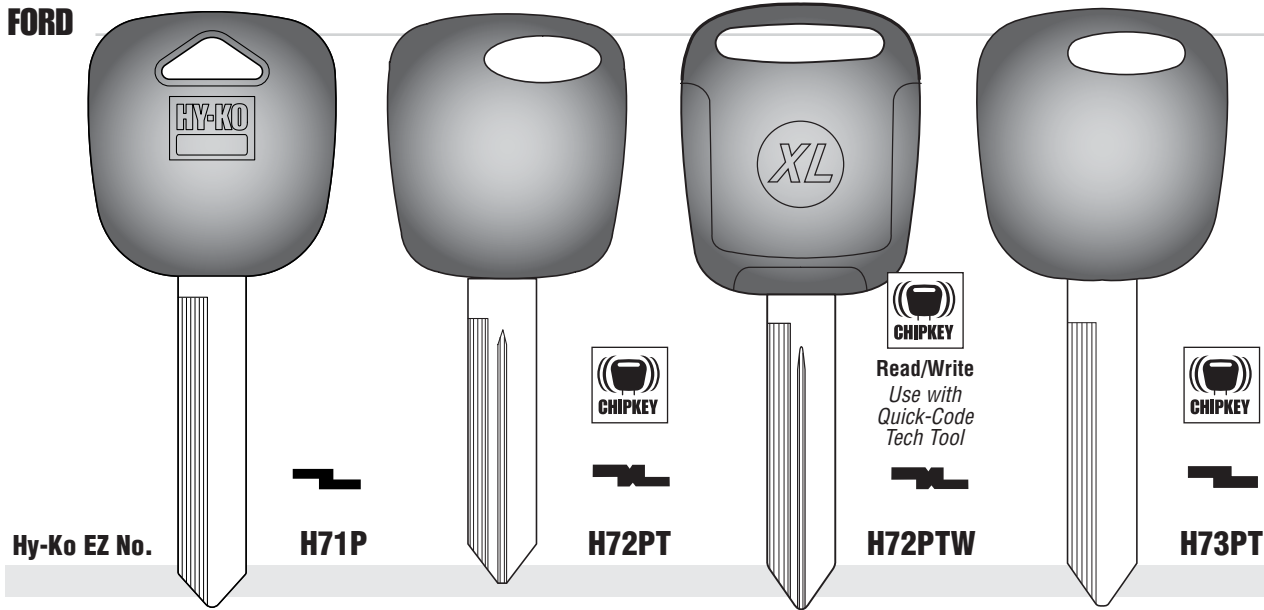

Hy-Ko EZ No.

H71P

H72PT

H72PTW

H73PT

FORD

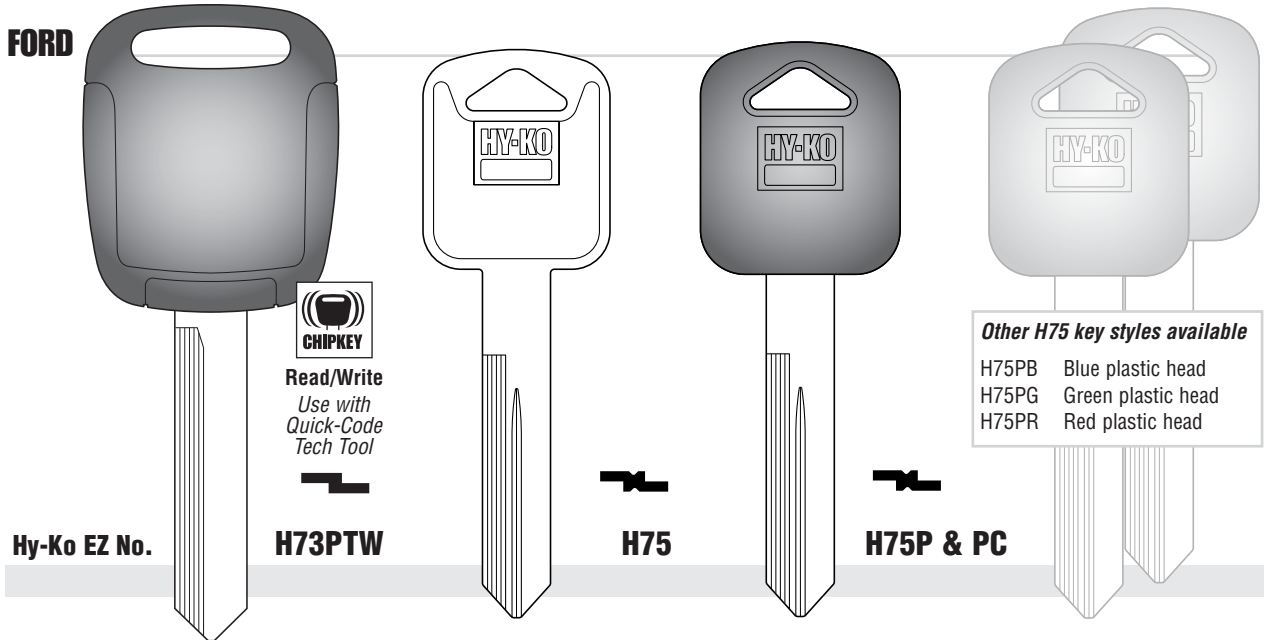

Hy-Ko EZ No.

H73PTW

H75

H75P & PC

Other H75 key styles available

- H75PB Blue plastic head
- H75PG Green plastic head
- H75PR Red plastic head

FORD

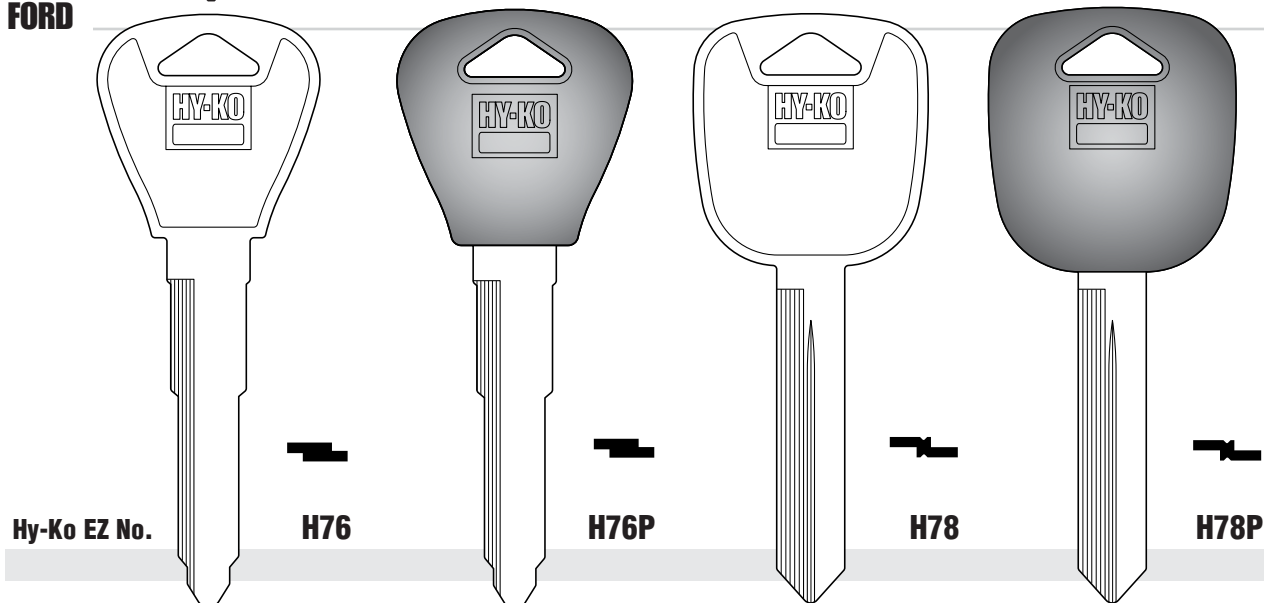

Hy-Ko EZ No.

H76

H76P

H78

H78P

Finding A Key

1 Look for identification marks on the key head (bow).

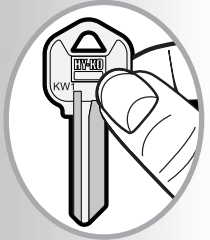

(i.e. manufacturer's name, key name, etc.)

2 Ask the customer how the key is used.

3 See reference sections:

- Key Cross Reference pp 76-92

P – Black plastic head
 PC – Color plastic head
 See page 4 for key name explanations

Automotive Keys

Identifying A Key

1 Find a key similar in size, key head shape, and millings.

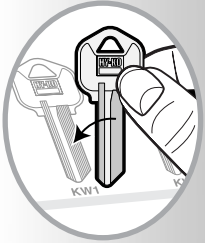

2

Raise key vertically on its tip and place on the key cross section.

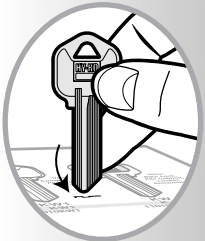

3

Match the grooves of the key to the keyway.

FORD

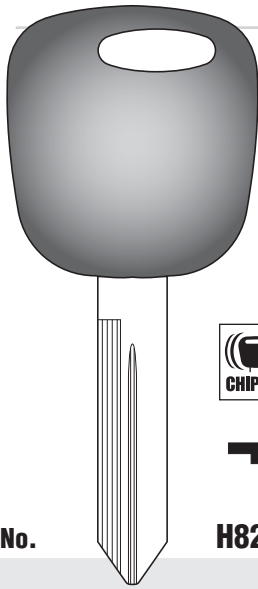

Hy-Ko EZ No.

H82PT

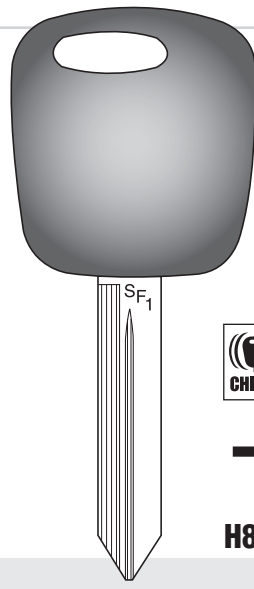

H86PT

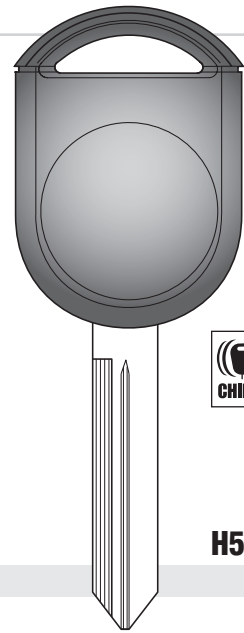

H599114PT

FORD

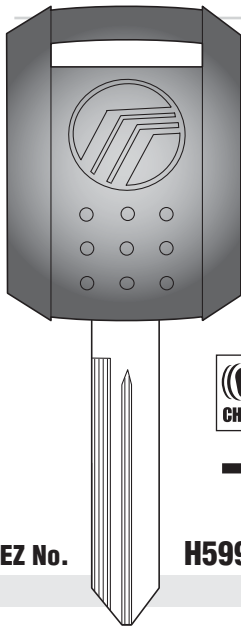

Hy-Ko EZ No.

H599179PT

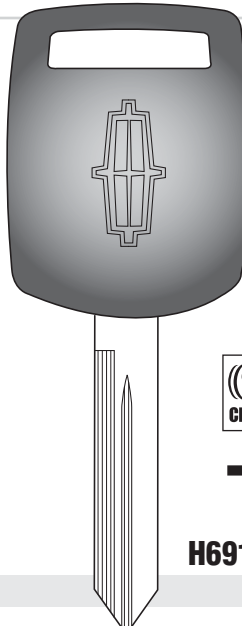

H691259PT

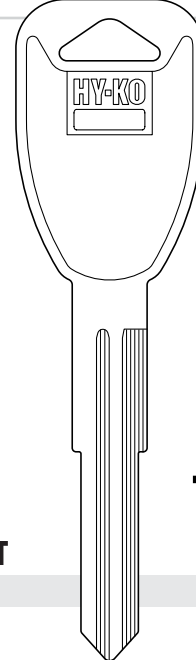

RV4

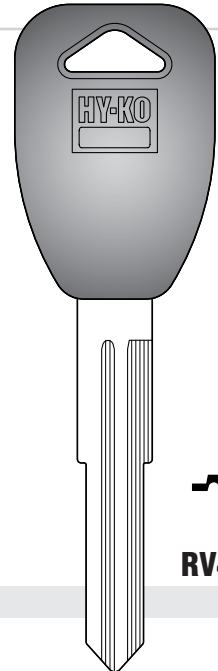

RV4P

FREIGHTLINER

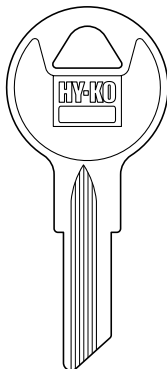

Hy-Ko EZ No.

B1

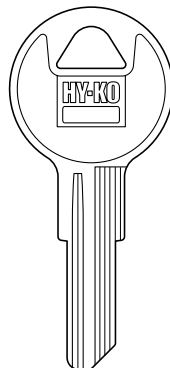

CG16

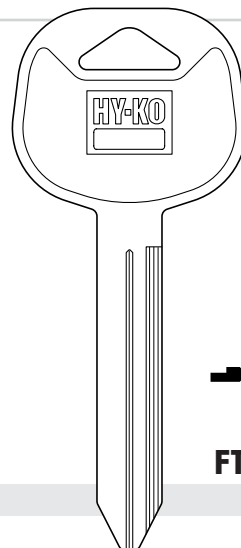

FTL1

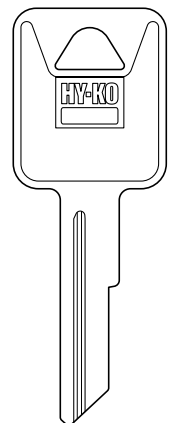

RA7

FREIGHTLINER

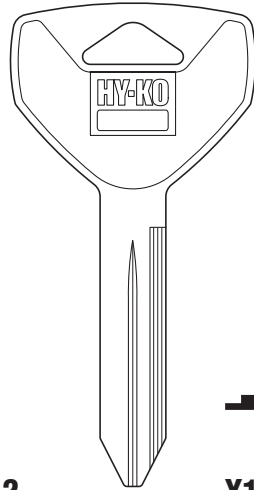

Hy-Ko EZ No. **Y12**

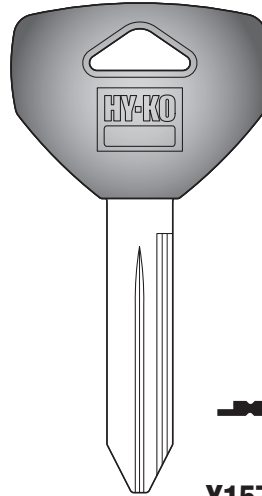

Y157



Y157P & PC

Other Y157 key styles available

- Y157PB Blue plastic head
- Y157PG Green plastic head
- Y157PR Red plastic head

Finding A Key

1 Look for identification marks on the key head (bow).

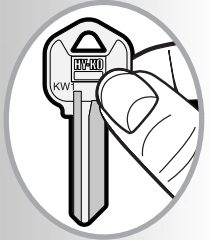

(i.e. manufacturer's name, key name, etc.)

2 Ask the customer how the key is used.

3 See reference sections:

- Key Cross Reference pp 76-92

P – Black plastic head
 PC – Color plastic head
 See page 4 for key name explanations

GENERAL MOTORS (Includes Buick, Cadillac, Chevrolet, Geo, GMC, Oldsmobile, Pontiac, Saturn)

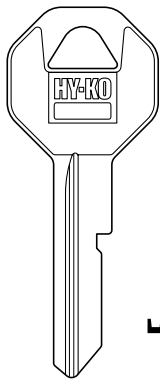

Hy-Ko EZ No. **B10**

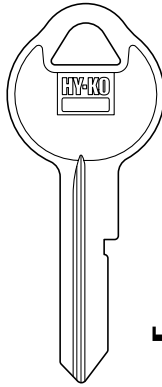

B11

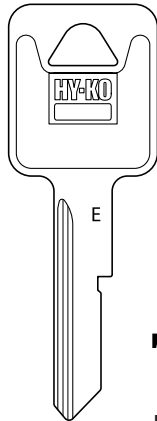

B44

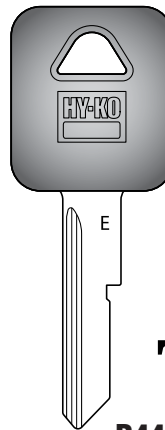

B44P & PC

Other B44 key styles available

- B44PB Blue plastic head
- B44PG Green plastic head
- B44PR Red plastic head
- B44A Aluminum; colors

GENERAL MOTORS

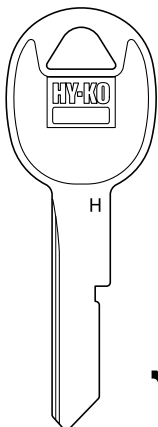

Hy-Ko EZ No. **B45**

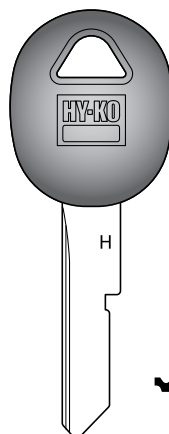

B45P & PC

Other B45 key styles available

- B45PB Blue plastic head
- B45PG Green plastic head
- B45PR Red plastic head
- B45A Aluminum; colors



Automotive Keys

GENERAL MOTORS

Identifying A Key

1 Find a key similar in size, key head shape, and millings.

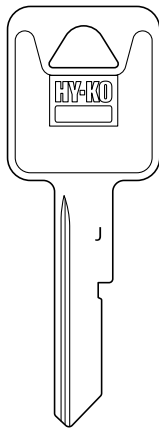
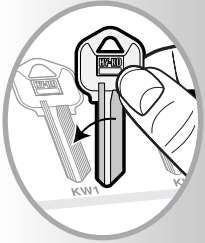

Hy-Ko EZ No.

B46

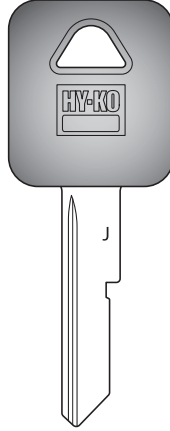

B46P

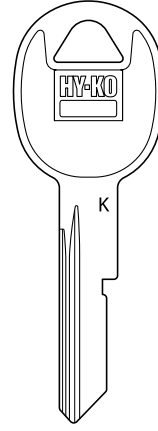

B47

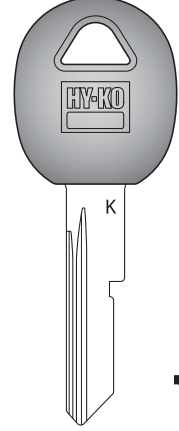

B47P

GENERAL MOTORS

2 Raise key vertically on its tip and place on the key cross section.

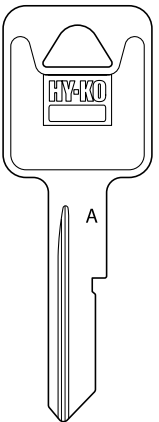
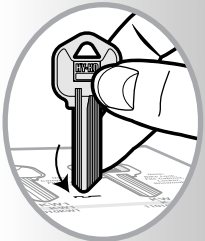

Hy-Ko EZ No.

B48

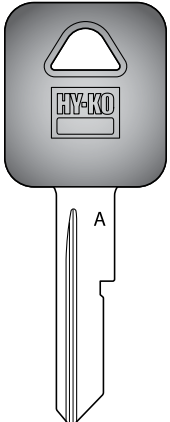

B48P & PC

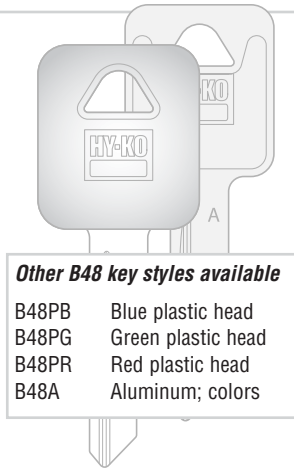

Other B48 key styles available

- B48PB Blue plastic head
- B48PG Green plastic head
- B48PR Red plastic head
- B48A Aluminum; colors

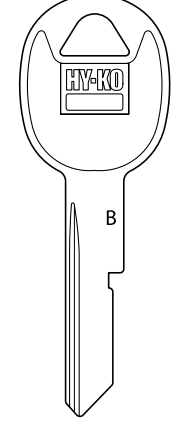

B49

GENERAL MOTORS

3 Match the grooves of the key to the keyway.

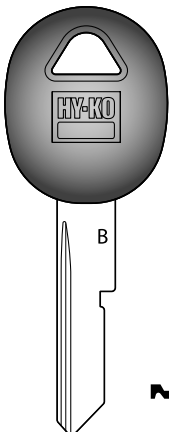
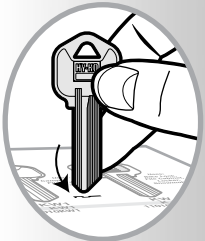

Hy-Ko EZ No.

B49P & PC



Other B49 key styles available

- B49PB Blue plastic head
- B49PG Green plastic head
- B49PR Red plastic head
- B49A Aluminum; colors

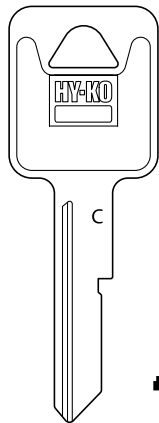

B50

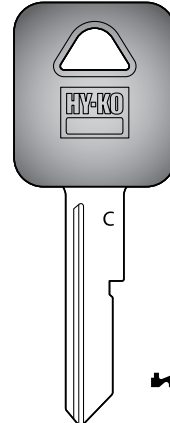

B50P & PC



Other B50 key styles available

- B50PB Blue plastic head
- B50PG Green plastic head
- B50PR Red plastic head
- B50A Aluminum; colors

GENERAL MOTORS

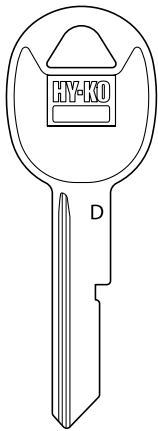

B51

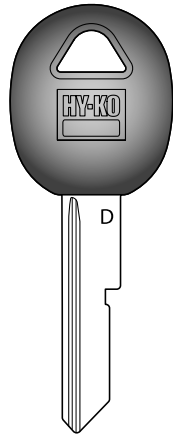

B51P & PC

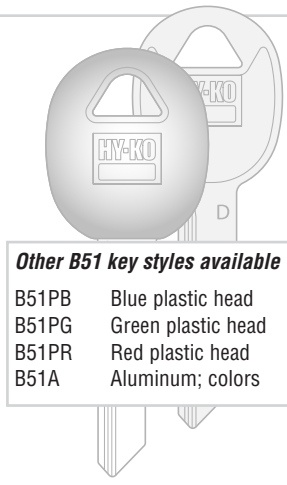

Other B51 key styles available

- B51PB Blue plastic head
- B51PG Green plastic head
- B51PR Red plastic head
- B51A Aluminum; colors



B52

Hy-Ko EZ No.

GENERAL MOTORS

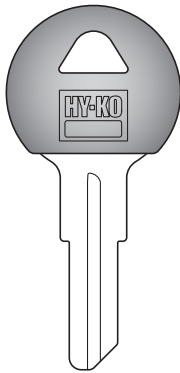

B52P

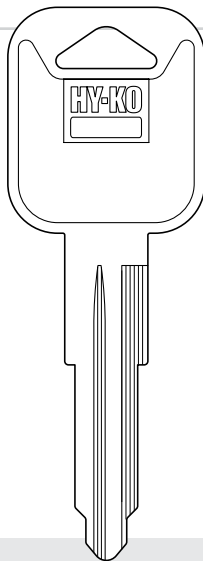

B53

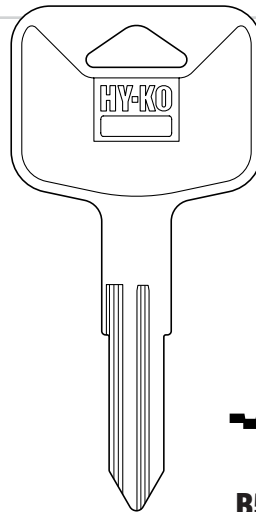

B54

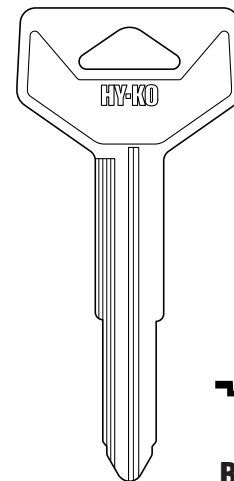

B55

Hy-Ko EZ No.

GENERAL MOTORS

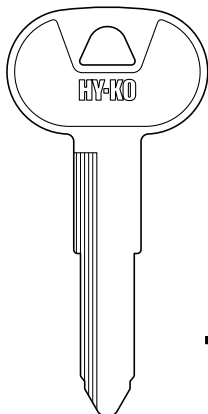

B56

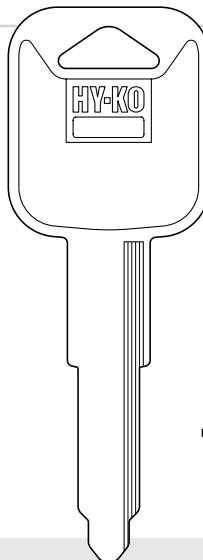

B58

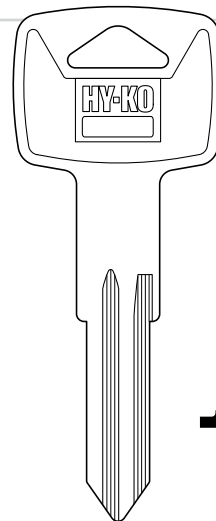

B61

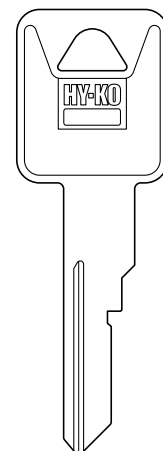

B62

Hy-Ko EZ No.

Finding A Key

1 Look for identification marks on the key head (bow).



(i.e. manufacturer's name, key name, etc.)

2 Ask the customer how the key is used.

3 See reference sections:

- Key Cross Reference pp 76-92

P – Black plastic head
 PC – Color plastic head
 See page 4 for key name explanations

Automotive Keys

GENERAL MOTORS

Identifying A Key

1 Find a key similar in size, key head shape, and millings.

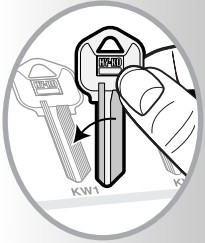

2 Raise key vertically on its tip and place on the key cross section.

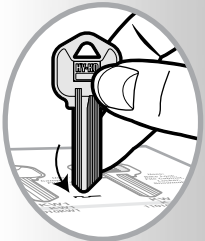

3 Match the grooves of the key to the keyway.

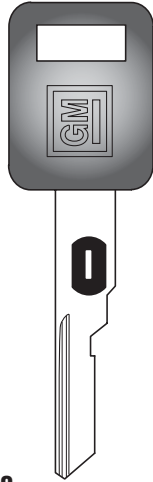

VATS

Vehicle Anti-Theft System

Keys feature resistor pellets embedded into the blade of the key. The key must match the resistor value of the ignition system for the vehicle to start.



Hy-Ko EZ No.

B62P1-P15

Single-sided

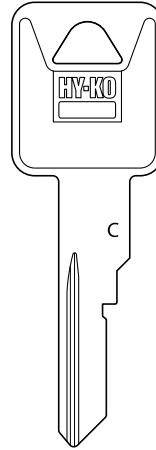

B63

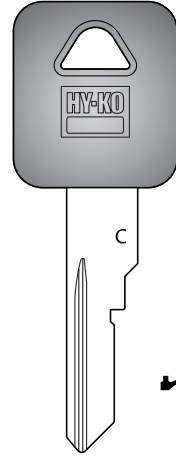

B63P & PC

GENERAL MOTORS

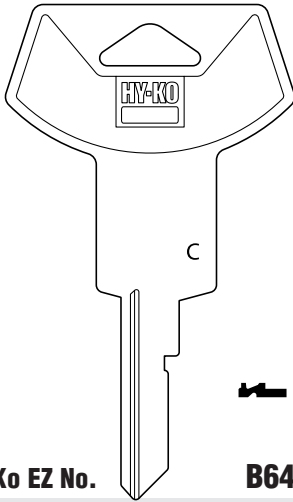

Hy-Ko EZ No.

B64

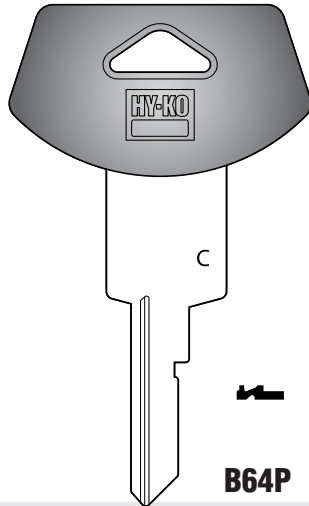

B64P

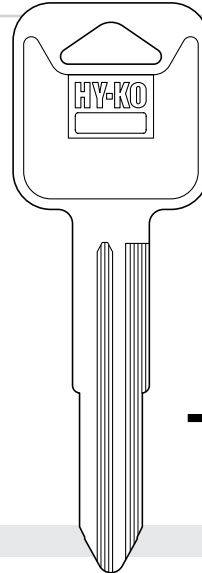

B65

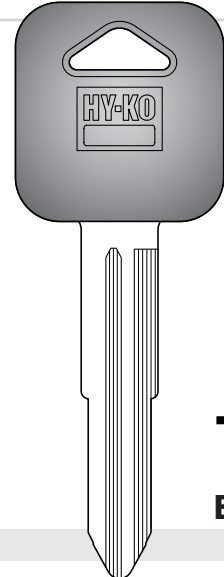

B65P

GENERAL MOTORS

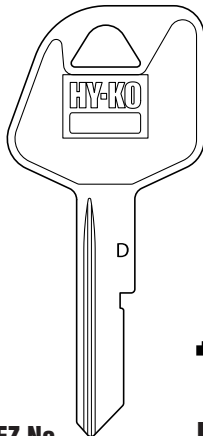

Hy-Ko EZ No.

B67

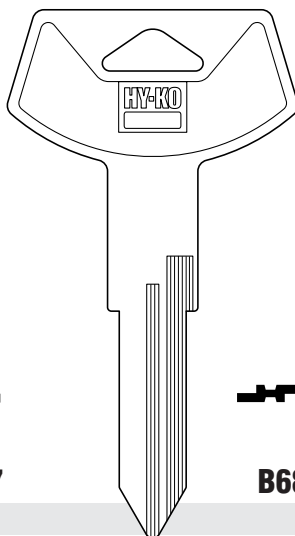

B68

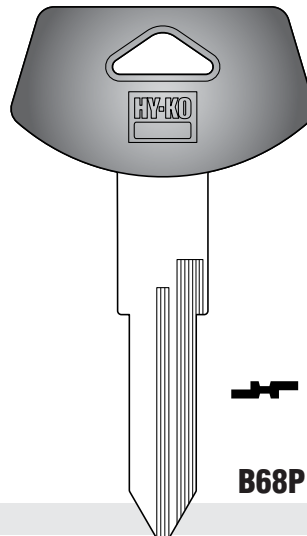

B68P

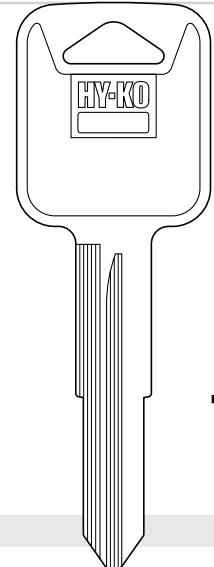

B69

GENERAL MOTORS

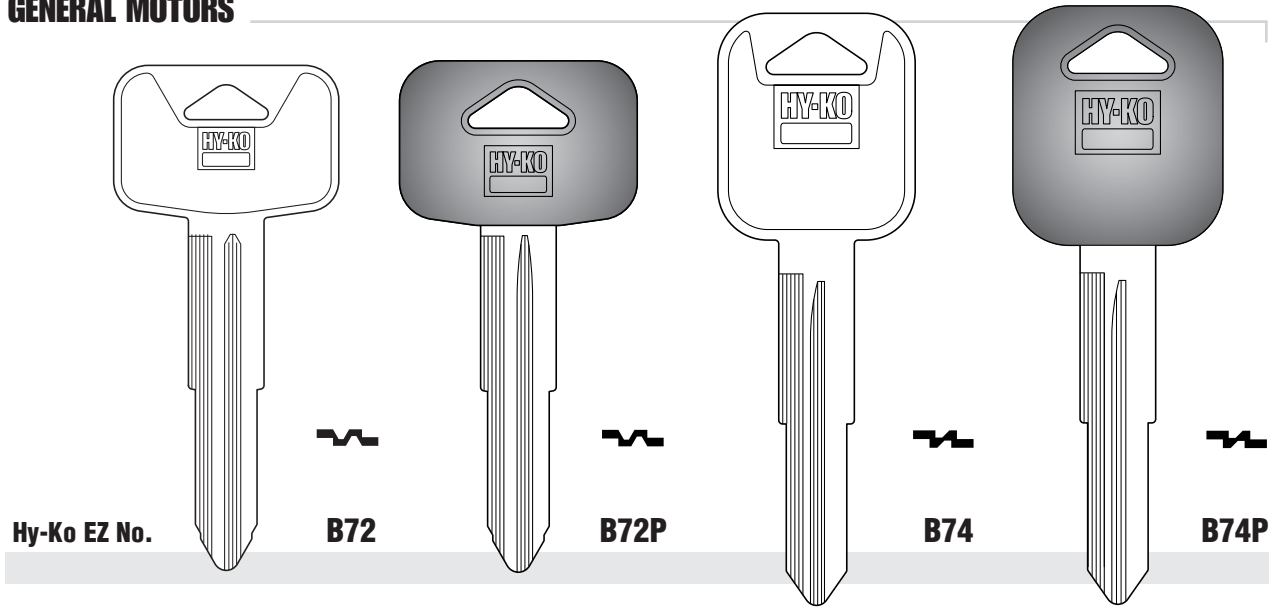

GENERAL MOTORS

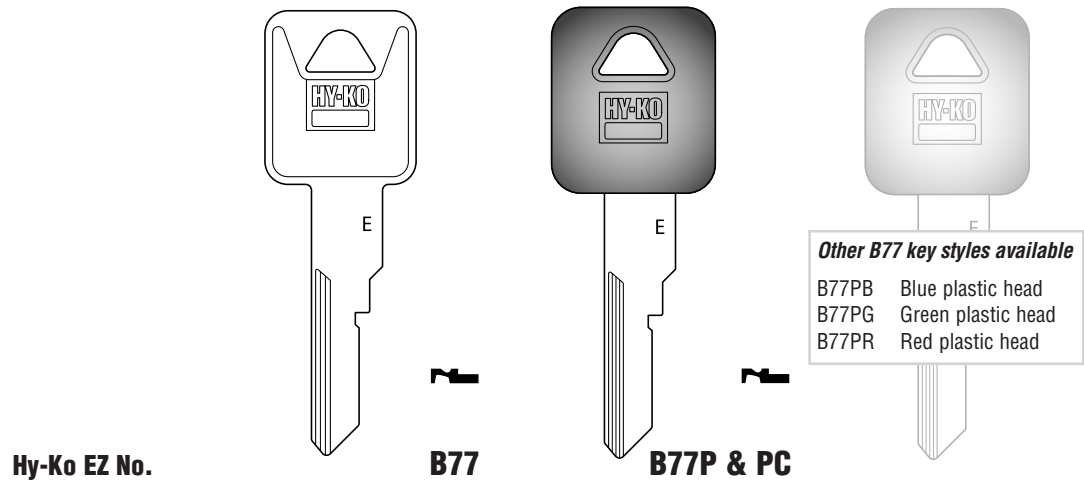

GENERAL MOTORS

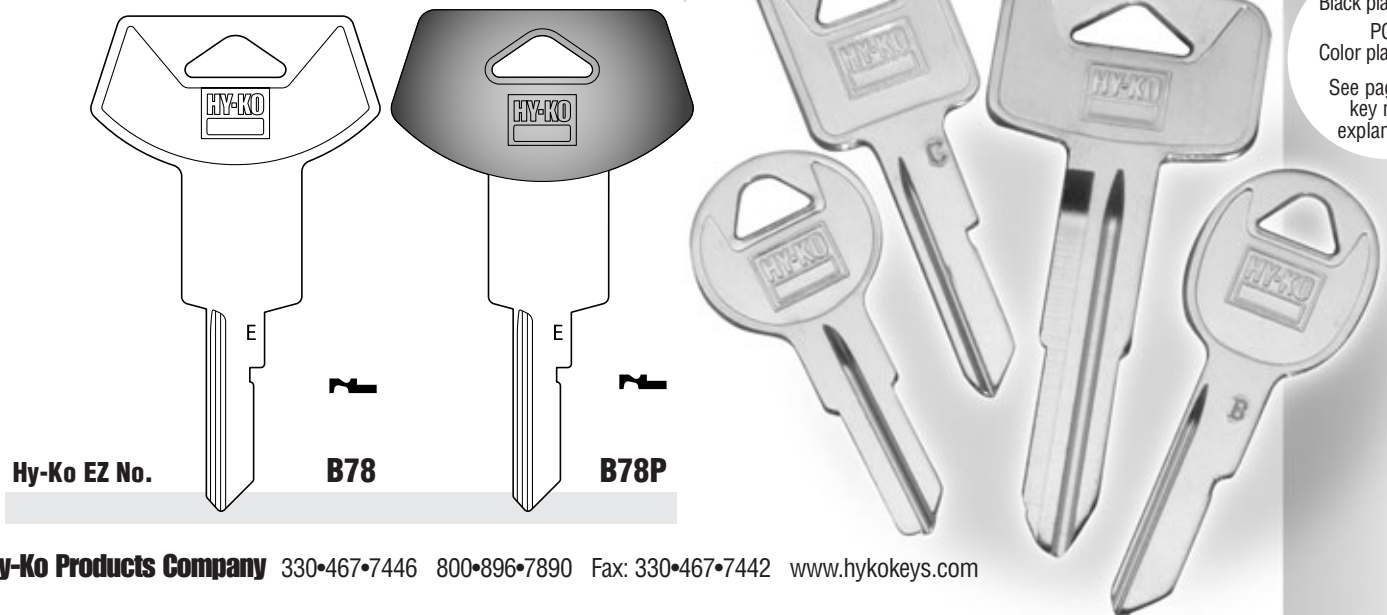

Finding A Key

1 Look for identification marks on the key head (bow).

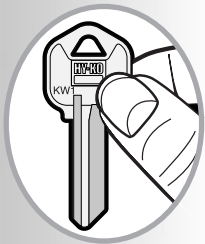

(i.e. manufacturer's name, key name, etc.)

2 Ask the customer how the key is used.

3 See reference sections:

• Key Cross Reference pp 76-92

Automotive Keys

GENERAL MOTORS

Identifying A Key

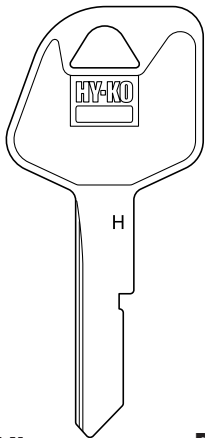

Hy-Ko EZ No.

B79

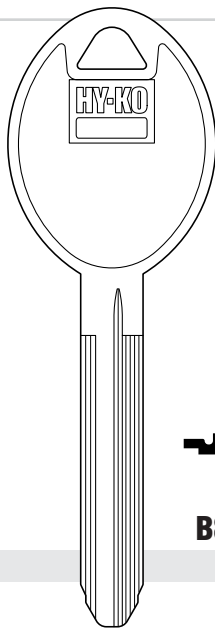

B80

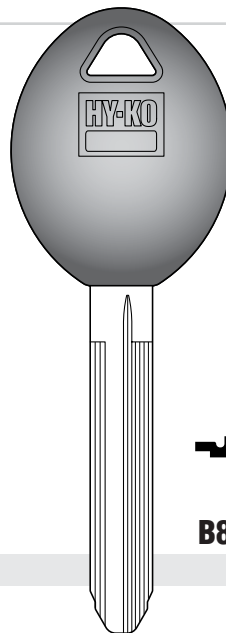

B80P

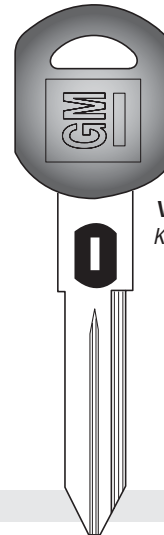

VATS
Vehicle Anti-Theft System
Keys feature resistor pellets embedded into the blade of the key. The key must match the resistor value of the ignition system for the vehicle to start.



B82P2-P15
Double-sided



1 Find a key similar in size, key head shape, and millings.

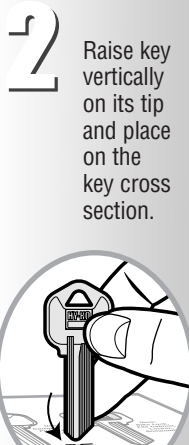

2 Raise key vertically on its tip and place on the key cross section.

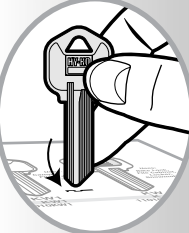

3 Match the grooves of the key to the keyway.

GENERAL MOTORS

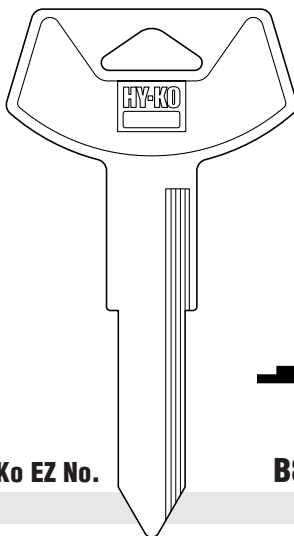

Hy-Ko EZ No.

B84

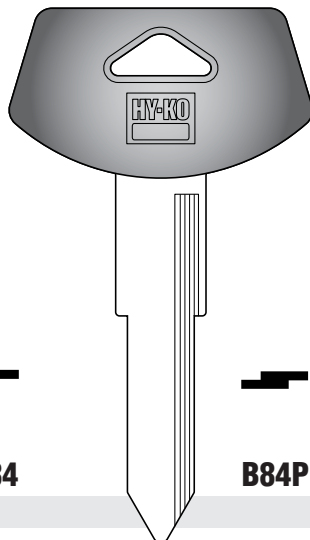

B84P

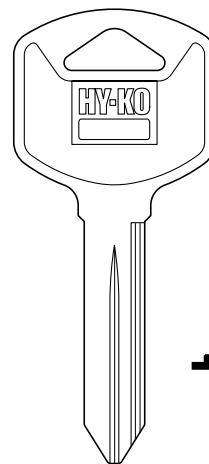

B85

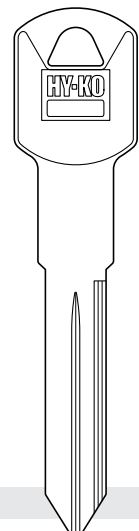

B86

GENERAL MOTORS

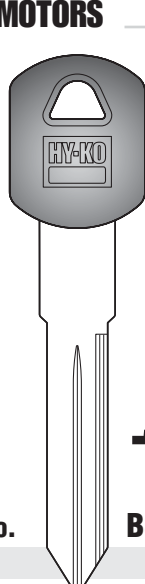

Hy-Ko EZ No.

B86P & PC

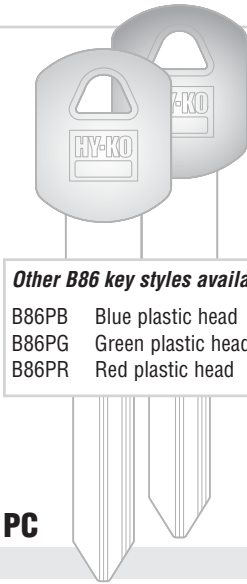

Other B86 key styles available

- B86PB Blue plastic head
- B86PG Green plastic head
- B86PR Red plastic head

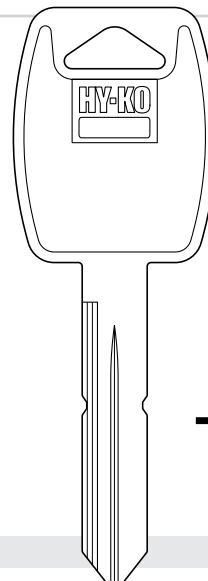

B88

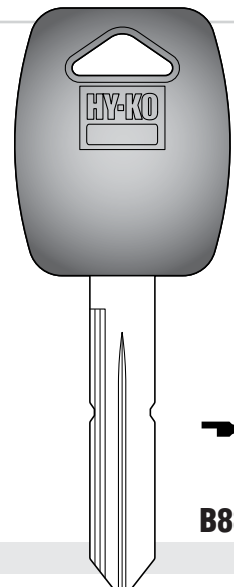

B88P

GENERAL MOTORS

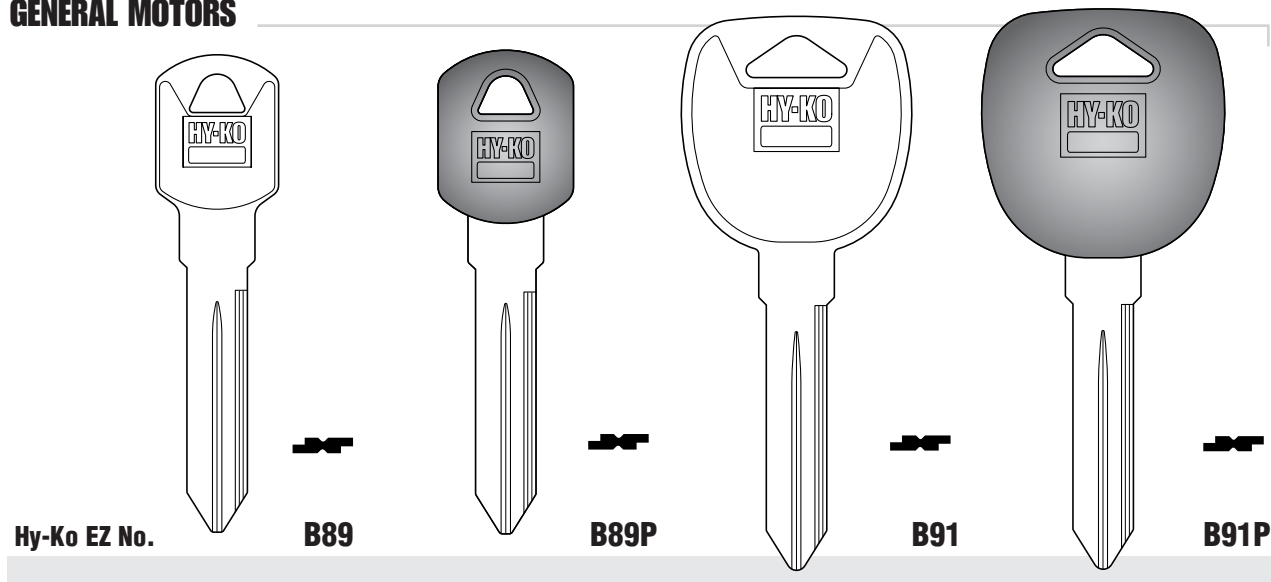

Hy-Ko EZ No.

B89

B89P

B91

B91P

GENERAL MOTORS

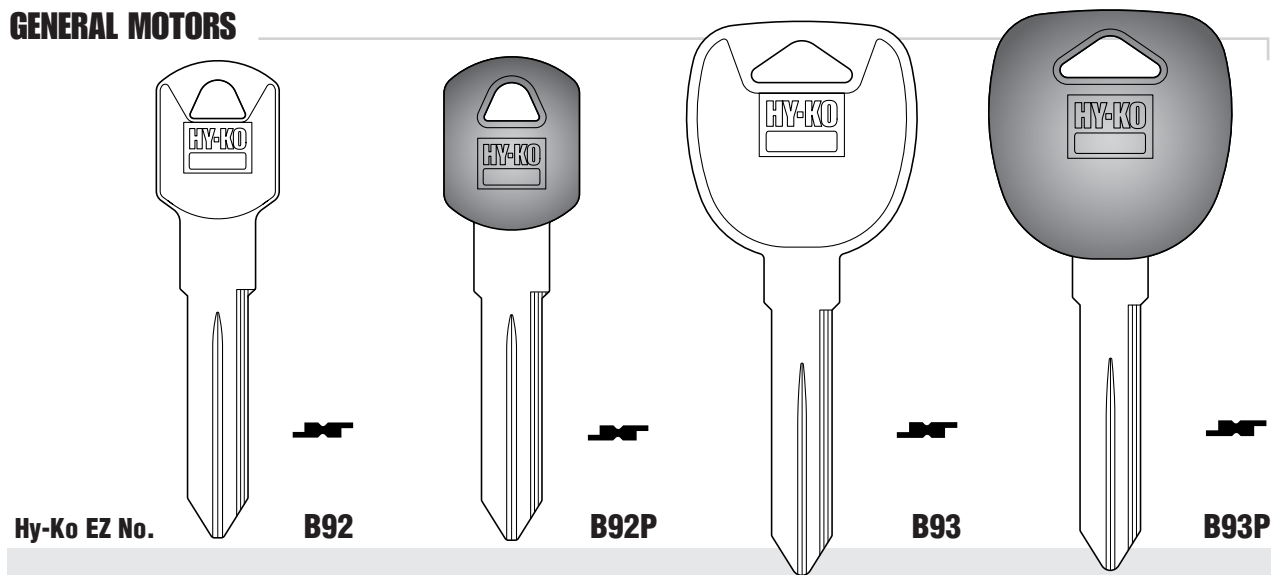

Hy-Ko EZ No.

B92

B92P

B93

B93P

GENERAL MOTORS

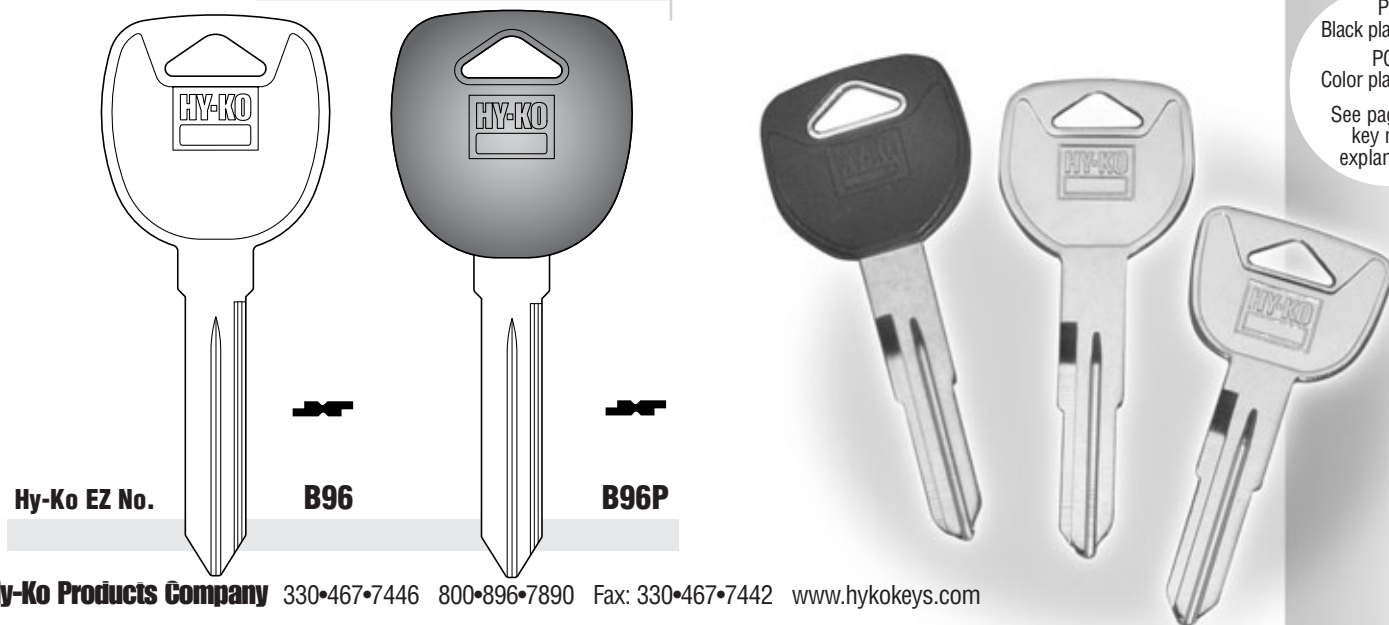

Hy-Ko EZ No.

B96

B96P

Finding A Key

1 Look for identification marks on the key head (bow).



(i.e. manufacturer's name, key name, etc.)

2 Ask the customer how the key is used.

3 See reference sections:

- Key Cross Reference pp 76-92

P – Black plastic head
 PC – Color plastic head
 See page 4 for key name explanations

Automotive Keys

GENERAL MOTORS

Identifying A Key

1 Find a key similar in size, key head shape, and millings.

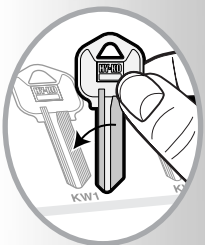

PK3



Hy-Ko EZ No.

B97PT

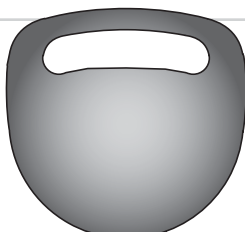

PK3



B99PT

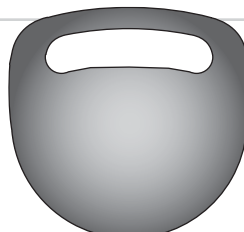

RW



Read/Write
Use with
Quick-Code
Tech Tool



B99PTW



Read/Write
Use with
Quick-Code
Tech Tool



B100PTW

GENERAL MOTORS

2 Raise key vertically on its tip and place on the key cross section.

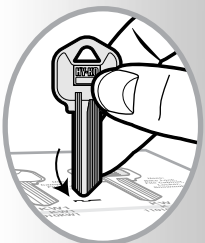

HY-KO



Hy-Ko EZ No.

B101



HY-KO



B102



HY-KO



B102P

GENERAL MOTORS

3 Match the grooves of the key to the keyway.



PK3
M



Hy-Ko EZ No.

B103PT

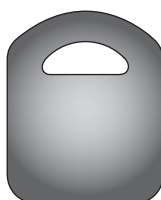

RW



Read/Write
Use with
Quick-Code
Tech Tool



B103PTW



VALET
KEY

PK3



B104PT



Read/Write
Use with
Quick-Code
Tech Tool



B104PTW

GENERAL MOTORS

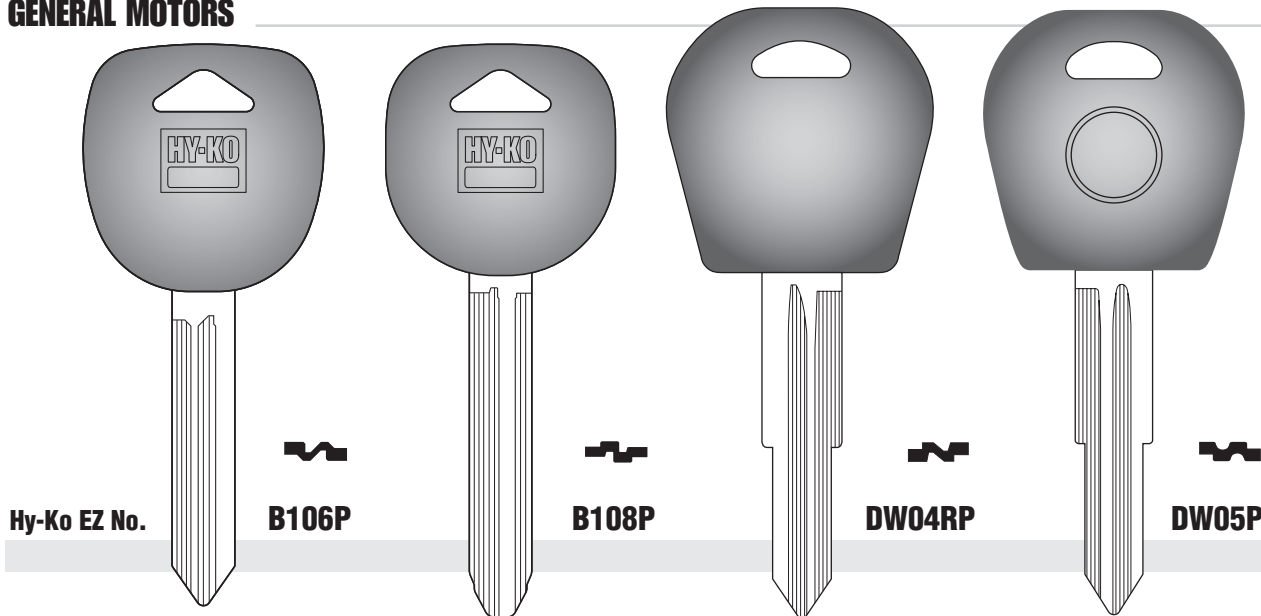

GENERAL MOTORS

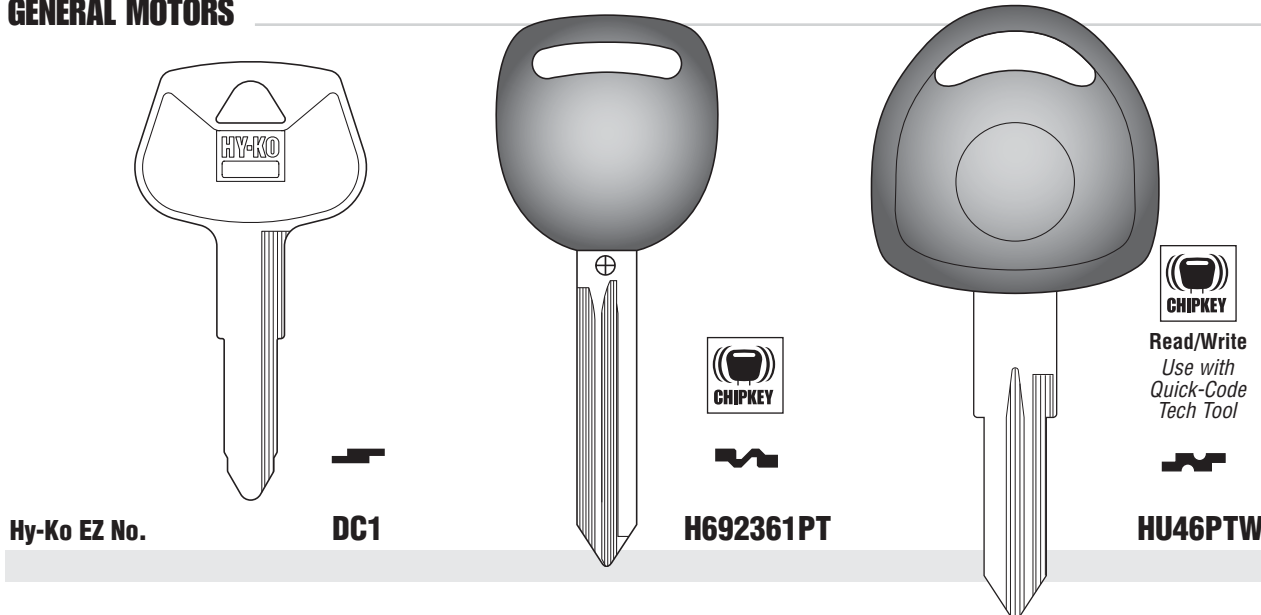

GENERAL MOTORS

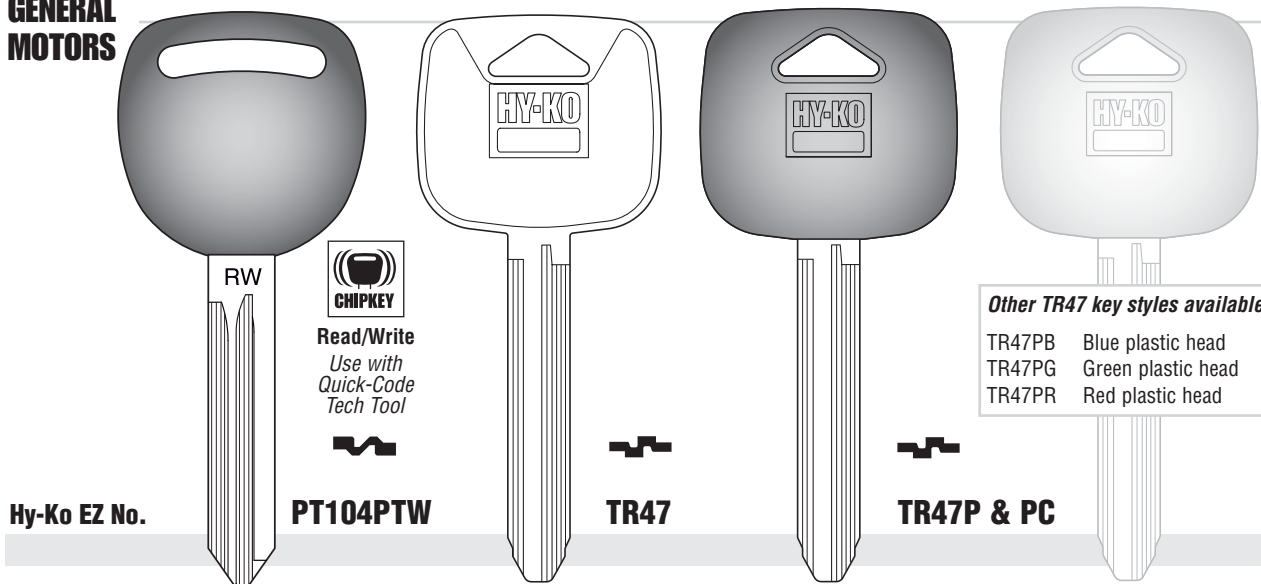

Finding A Key

1 Look for identification marks on the key head (bow).

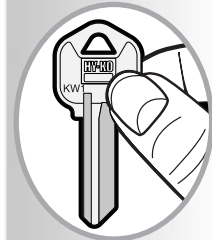

(i.e. manufacturer's name, key name, etc.)

2 Ask the customer how the key is used.

3 See reference sections:

- Key Cross Reference pp 76-92

P – Black plastic head
 PC – Color plastic head
 See page 4 for key name explanations

Automotive Keys

GEO, GMC

HARLEY-DAVIDSON MOTORCYCLE

HINO TRUCK

See
**GENERAL
MOTORS**
Automotive
on pg 15

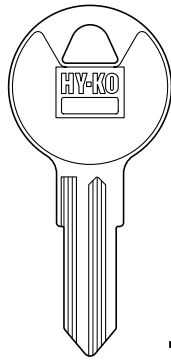

Hy-Ko EZ No. **HYD12**

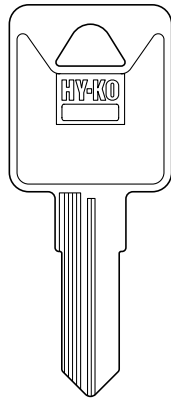

Hy-Ko EZ No. **HYD13**

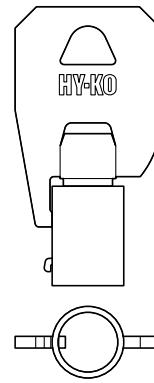

*Tubular
Key:
requires
special
key machine*

Hy-Ko EZ No. **FH1**

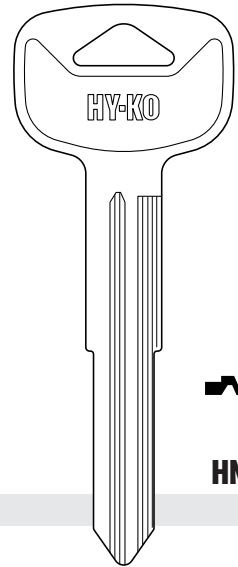

Hy-Ko EZ No. **HN3**

Identifying A Key

1 Find a key similar in size, key head shape, and millings.

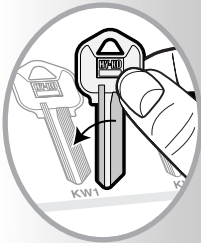

2 Raise key vertically on its tip and place on the key cross section.

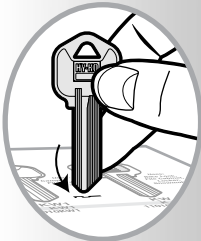

3 Match the grooves of the key to the keyway.

HONDA (Includes ACURA)

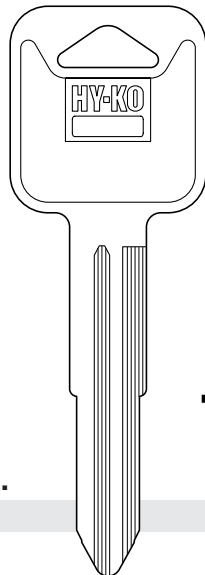

Hy-Ko EZ No. **B65**

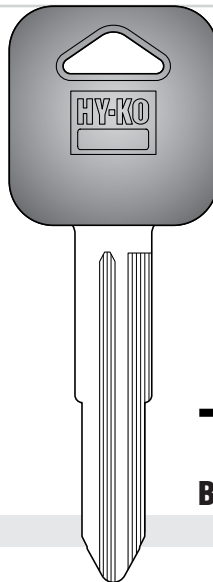

Hy-Ko EZ No. **B65P**

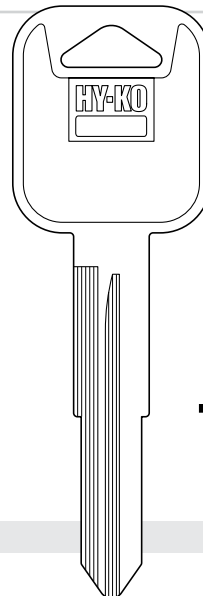

Hy-Ko EZ No. **B74**

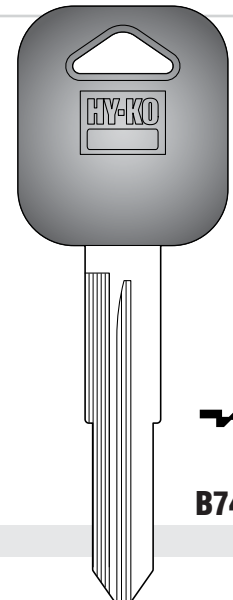

Hy-Ko EZ No. **B74P**

HONDA

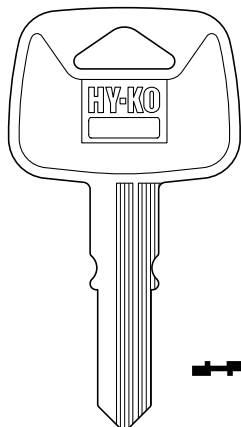

Hy-Ko EZ No. **HD70U**

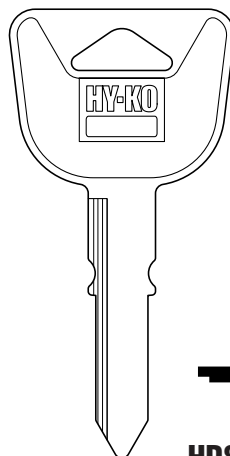

Hy-Ko EZ No. **HD82**

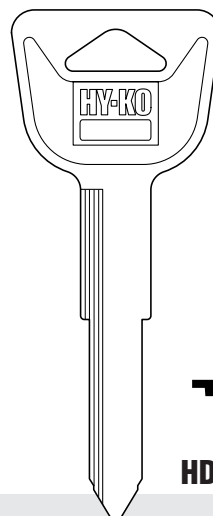

Hy-Ko EZ No. **HD90**

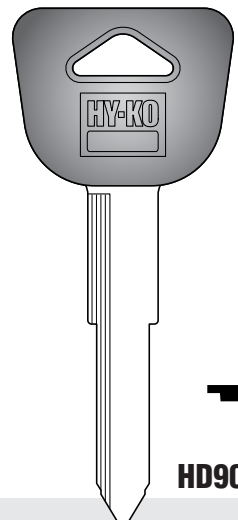

Hy-Ko EZ No. **HD90P**

HONDA

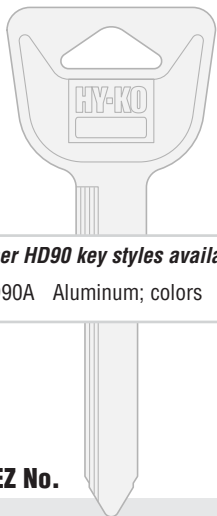

Other HD90 key styles available
HD90A Aluminum; colors

Hy-Ko EZ No.

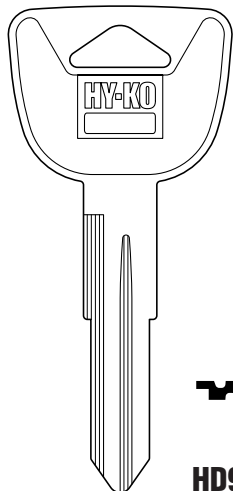

HD91

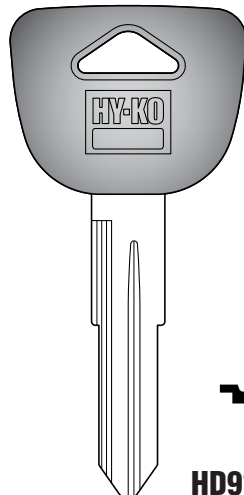

HD91P

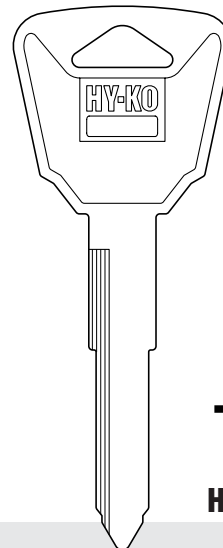

HD92

HONDA

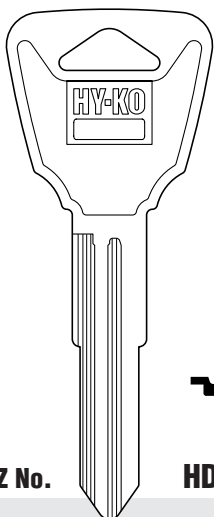

Hy-Ko EZ No.

HD96

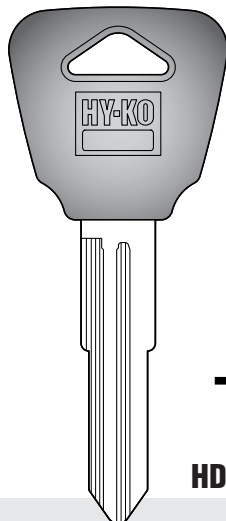

HD96P

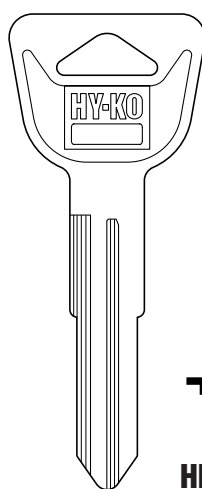

HD98

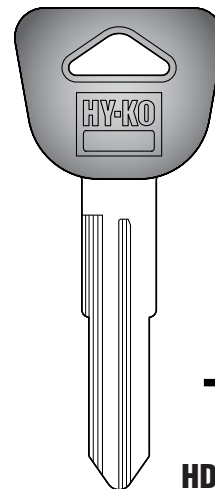

HD98P

HONDA

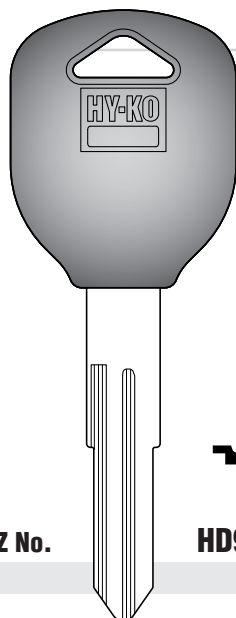

Hy-Ko EZ No.

HD99P

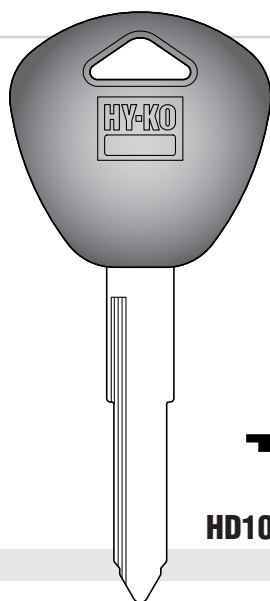

HD101P



Finding A Key

1 Look for identification marks on the key head (bow).



(i.e. manufacturer's name, key name, etc.)

2 Ask the customer how the key is used.

3 See reference sections:

- Key Cross Reference pp 76-92

P – Black plastic head
PC – Color plastic head
See page 4 for key name explanations

Automotive Keys

HONDA

Identifying A Key

1 Find a key similar in size, key head shape, and millings.

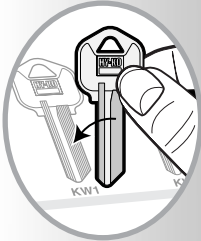

2 Raise key vertically on its tip and place on the key cross section.

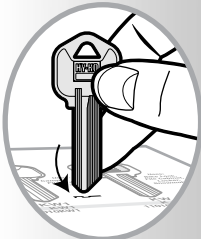

3 Match the grooves of the key to the keyway.

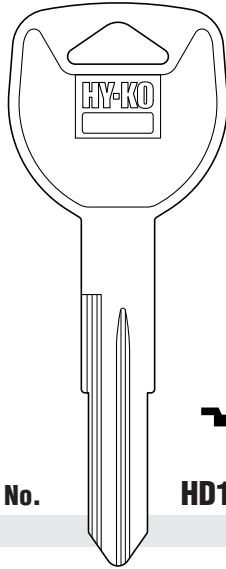

Hy-Ko EZ No.

HD103

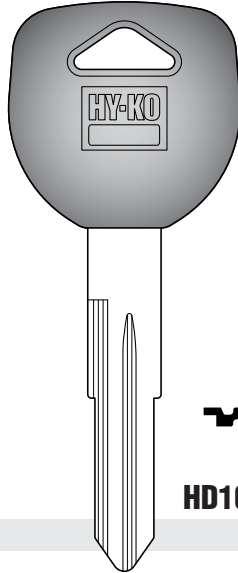

HD103P

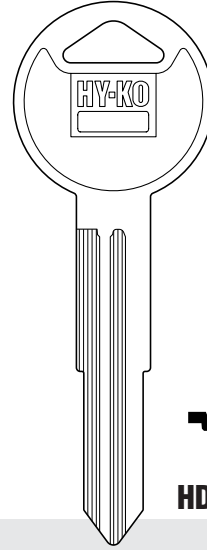

HD104

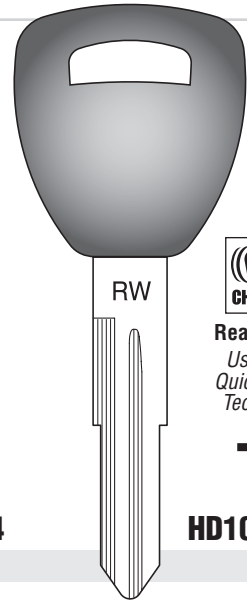

Read/Write
Use with
Quick-Code
Tech Tool



HD106PTW

HONDA

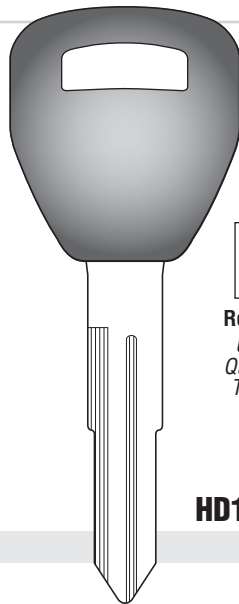

Read/Write
Use with
Quick-Code
Tech Tool



Hy-Ko EZ No.

HD107PTW

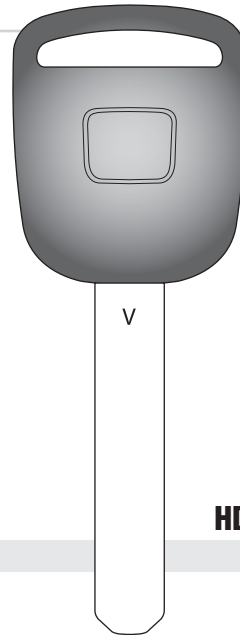

Read/Write
Use with
Quick-Code
Tech Tool



HD110PTW

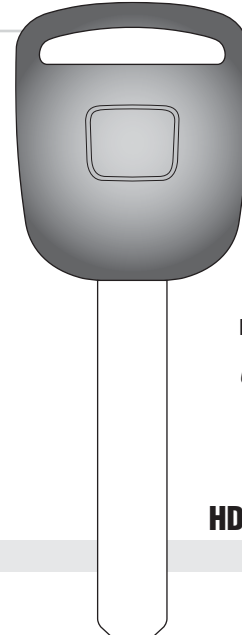

Read/Write
Use with
Quick-Code
Tech Tool



HD111PTW

HONDA MOTORCYCLE

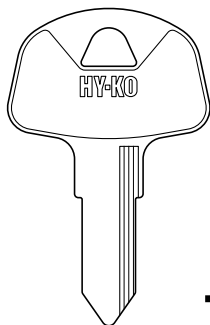

Hy-Ko EZ No.

HD57

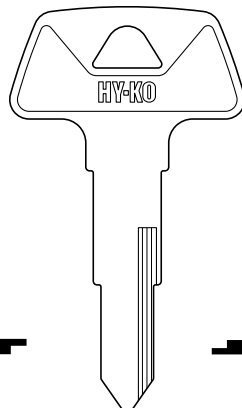

HD74

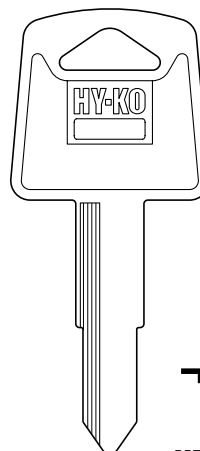

HD75

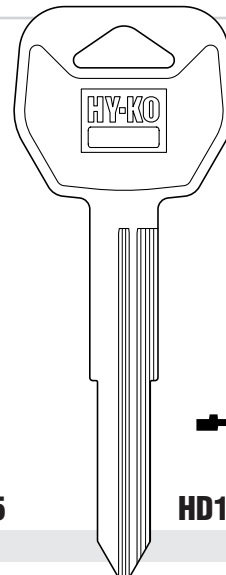

HD109

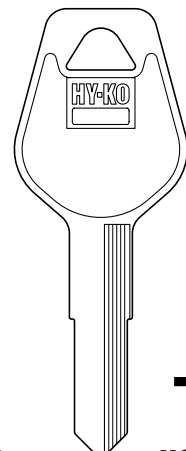

HO44

HUMMER

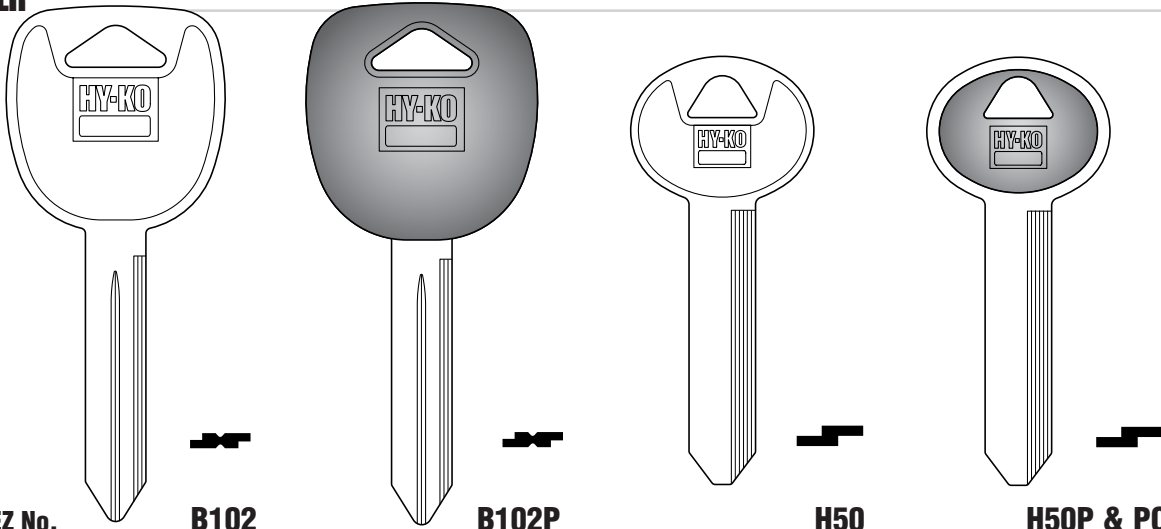

Hy-Ko EZ No.

B102

B102P

H50

H50P & PC

HUMMER

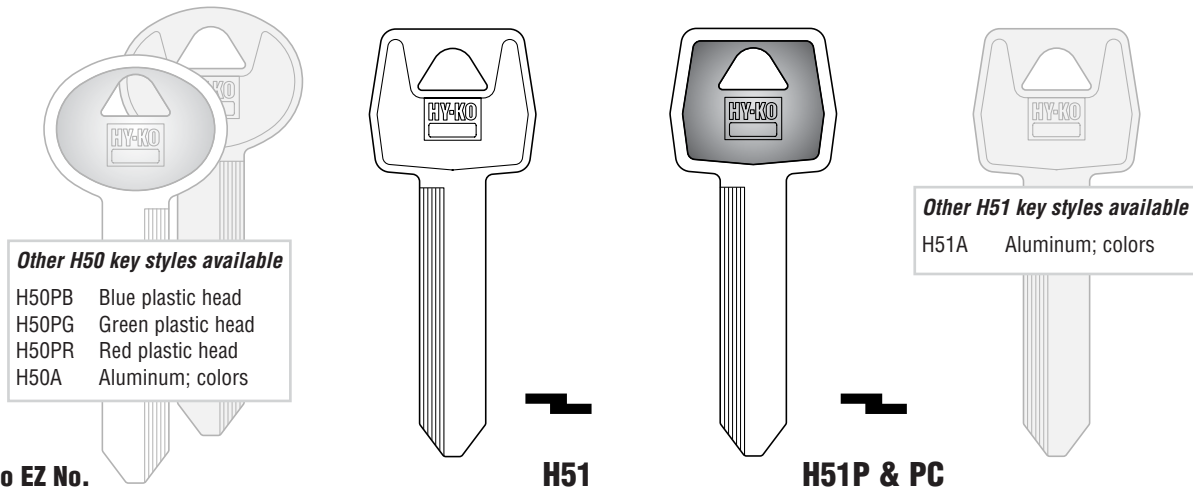

Other H50 key styles available
 H50PB Blue plastic head
 H50PG Green plastic head
 H50PR Red plastic head
 H50A Aluminum; colors

Other H51 key styles available
 H51A Aluminum; colors

Hy-Ko EZ No.

H51

H51P & PC

HYUNDAI

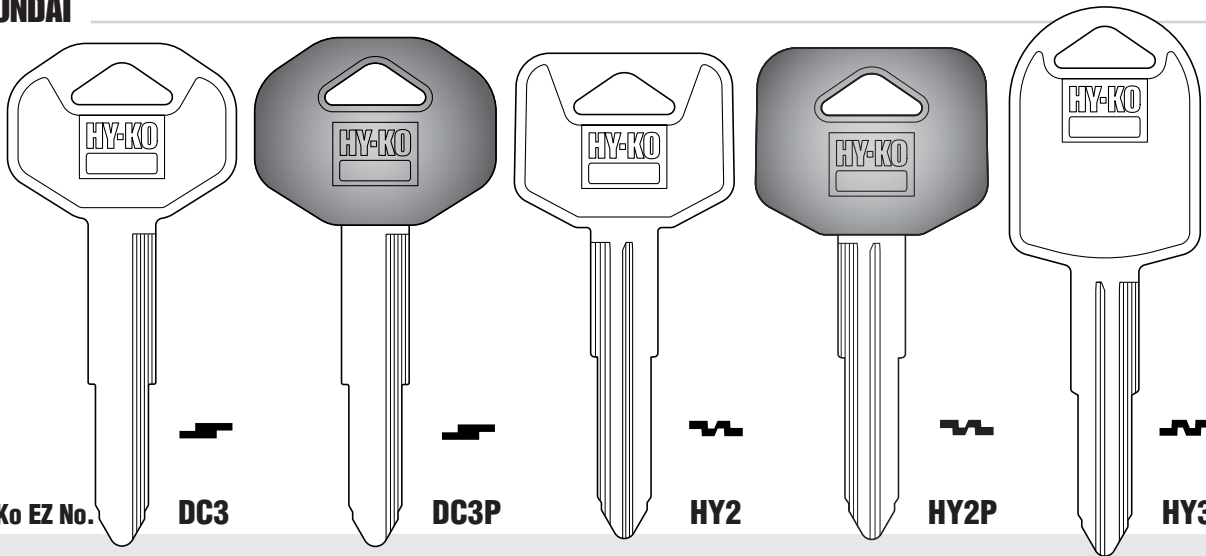

Hy-Ko EZ No.

DC3

DC3P

HY2

HY2P

HY3

Finding A Key

1 Look for identification marks on the key head (bow).



(i.e. manufacturer's name, key name, etc.)

2 Ask the customer how the key is used.

3 See reference sections:

- Key Cross Reference pp 76-92

P – Black plastic head
 PC – Color plastic head
 See page 4 for key name explanations

Automotive Keys

HYUNDAI

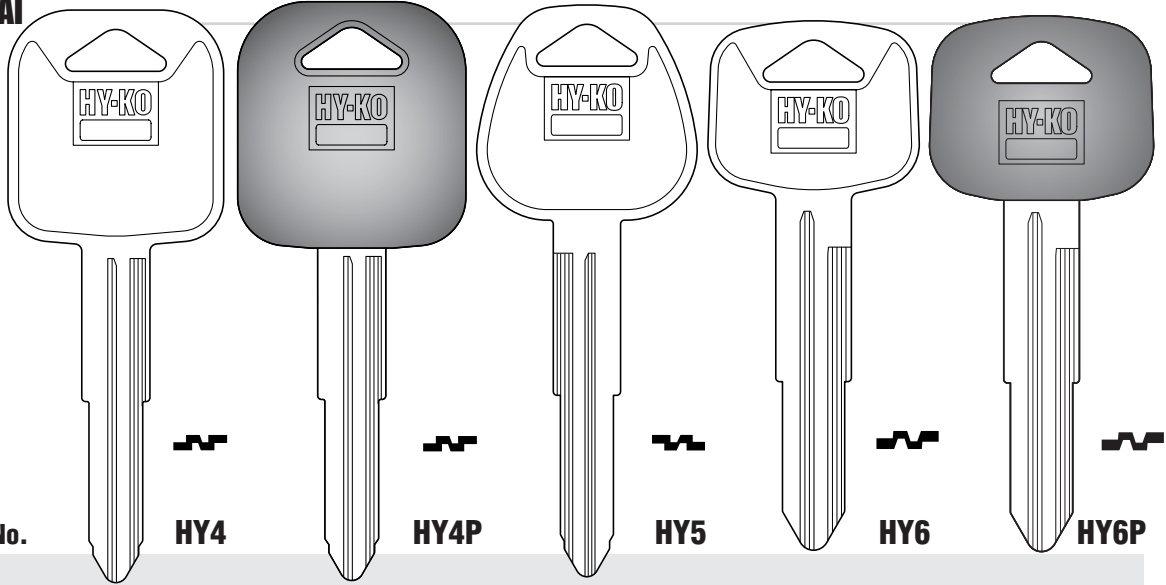

Hy-Ko EZ No.

HY4

HY4P

HY5

HY6

HY6P

Identifying A Key

1 Find a key similar in size, key head shape, and millings.

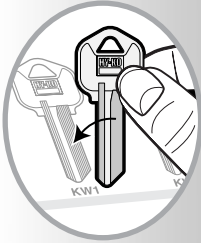

2

Raise key vertically on its tip and place on the key cross section.

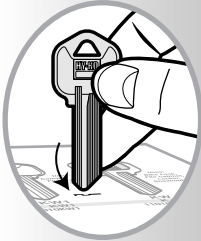

3

Match the grooves of the key to the keyway.

HYUNDAI

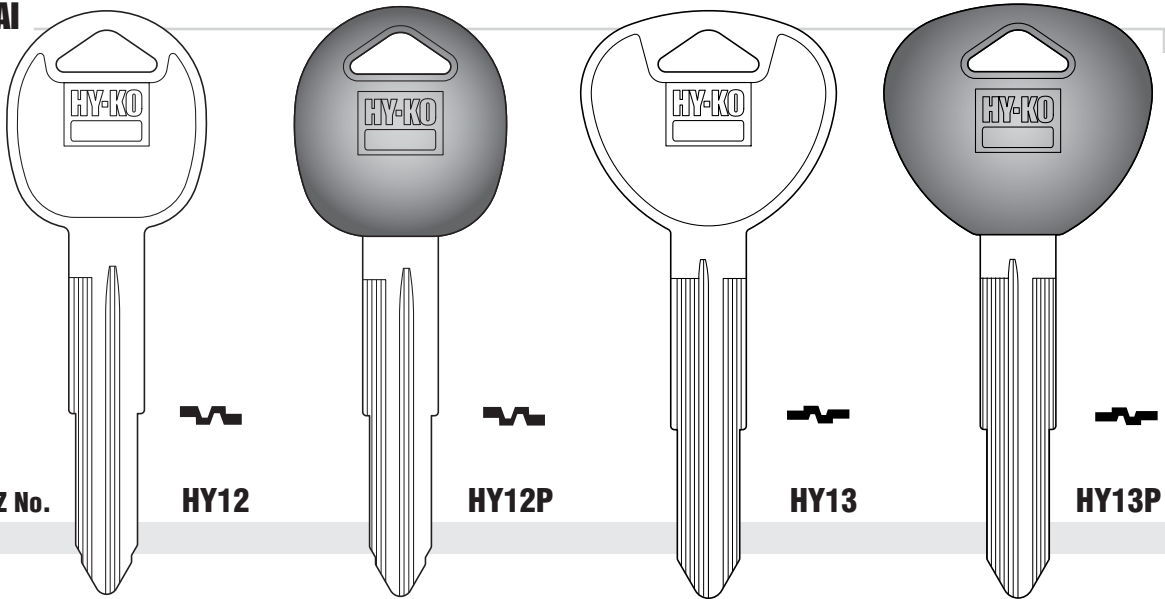

Hy-Ko EZ No.

HY12

HY12P

HY13

HY13P

HYUNDAI

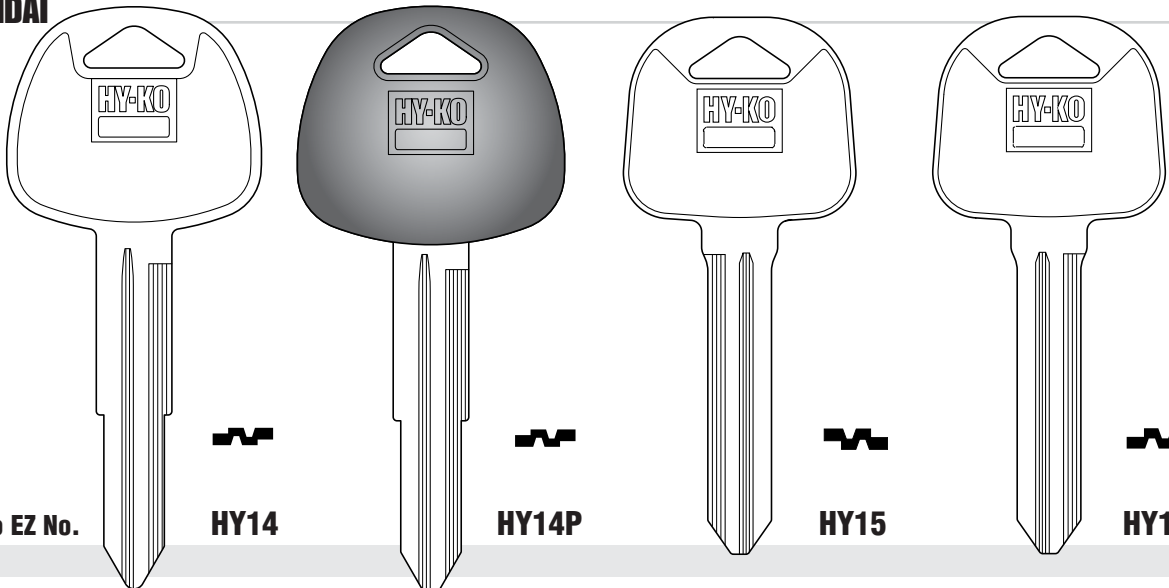

Hy-Ko EZ No.

HY14

HY14P

HY15

HY16

INFINITI

ISUZU

**See NISSAN
Automotive
on pg 38**

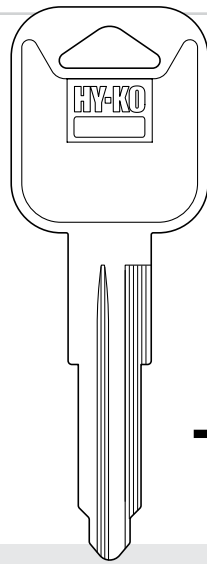

B53

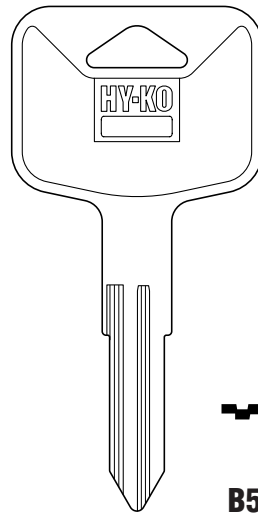

B54

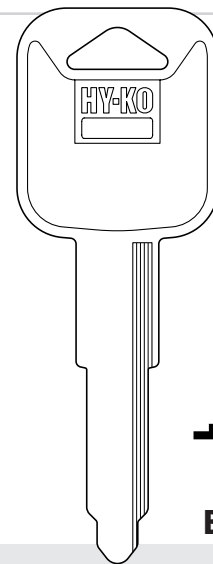

B58

Hy-Ko EZ No.

ISUZU

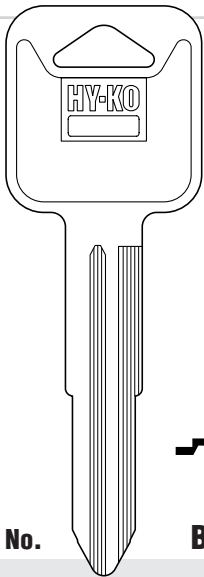

B65

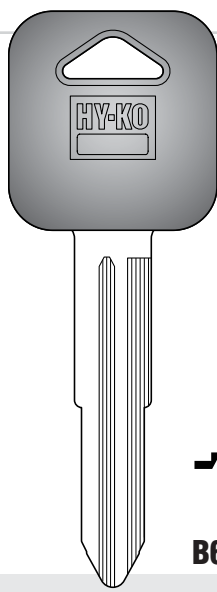

B65P

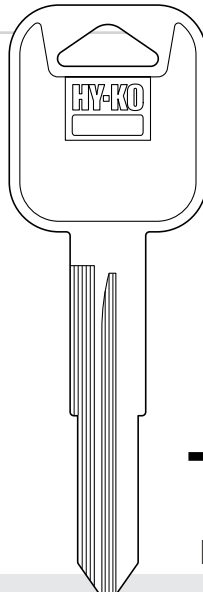

B74

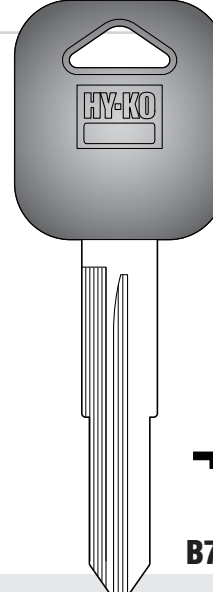

B74P

Hy-Ko EZ No.

ISUZU

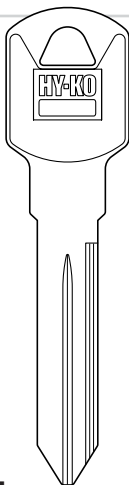

B89

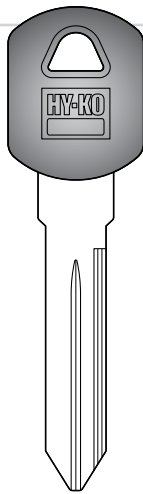

B89P

Hy-Ko EZ No.

Finding A Key

1 Look for identification marks on the key head (bow).



(i.e. manufacturer's name, key name, etc.)

2 Ask the customer how the key is used.

3 See reference sections:

- Key Cross Reference pp 76-92

P – Black plastic head
PC – Color plastic head
See page 4 for key name explanations



Automotive Keys

Identifying A Key

1 Find a key similar in size, key head shape, and millings.

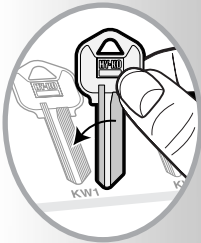

2

Raise key vertically on its tip and place on the key cross section.

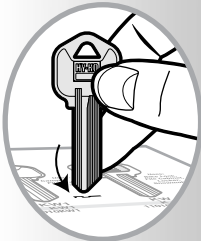

3

Match the grooves of the key to the keyway.

ISUZU

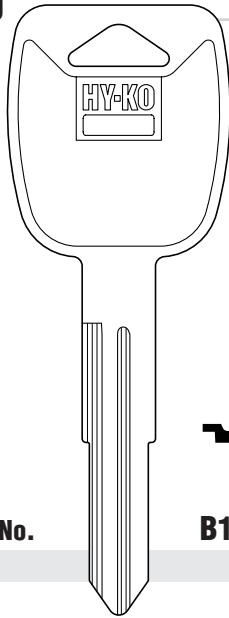

B101

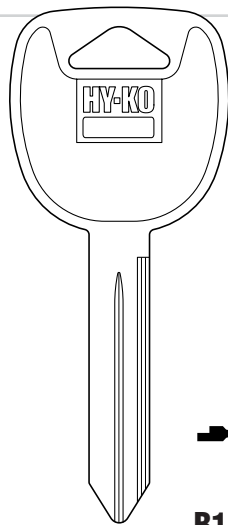

B102

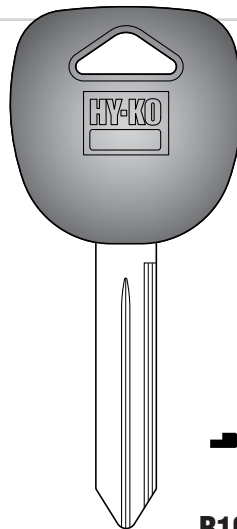

B102P

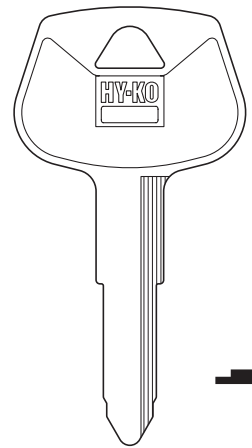

DC1

Hy-Ko EZ No.

ISUZU

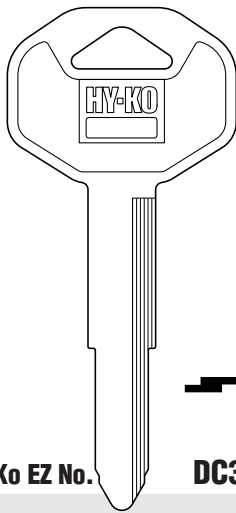

DC3

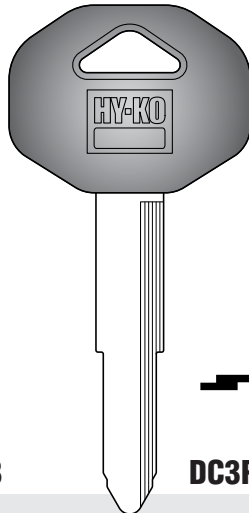

DC3P

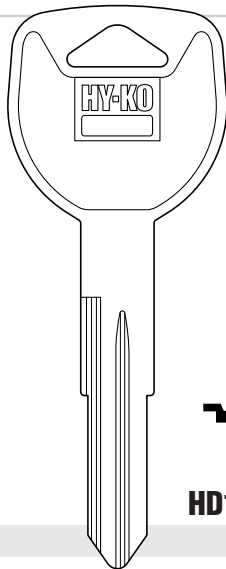

HD103

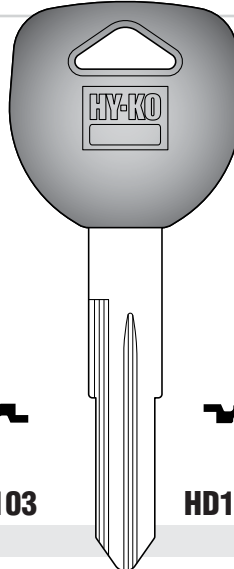

HD103P

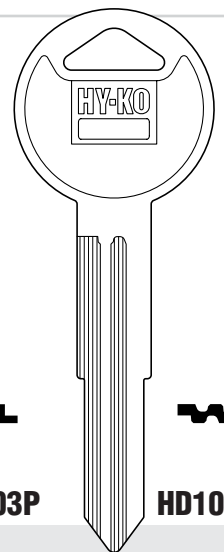

HD104

Hy-Ko EZ No.

JEEP

JOHN DEERE

See CHRYSLER Automotive on pg 7

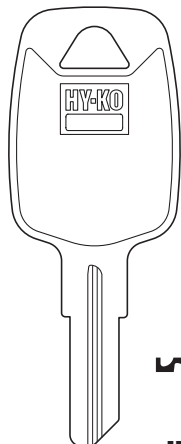

JD1

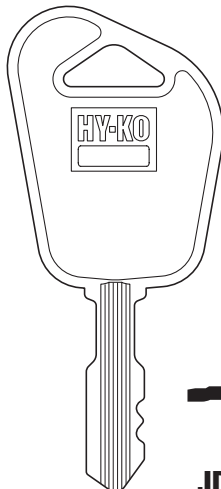

JD2

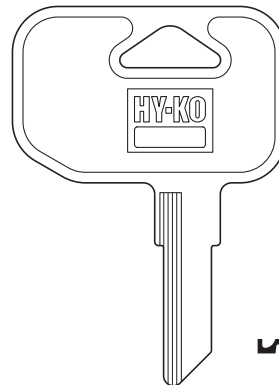

JD3

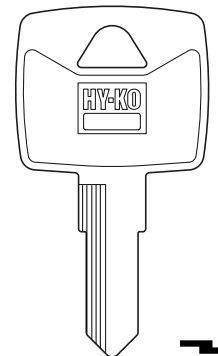

JD4

Hy-Ko EZ No.

KAWASAKI MOTORCYCLE

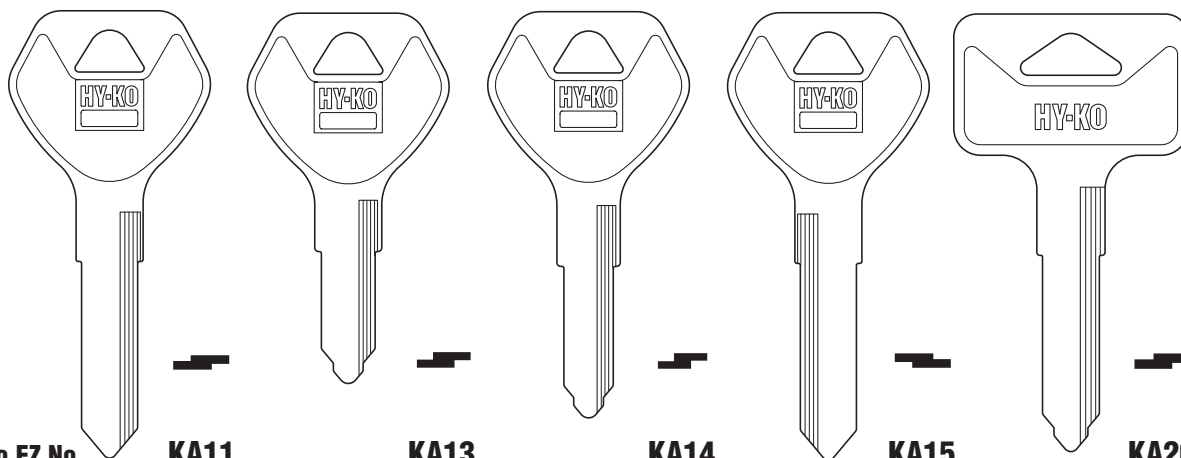

Hy-Ko EZ No. **KA11** **KA13** **KA14** **KA15** **KA20**

KAWASAKI MOTORCYCLE

KIA

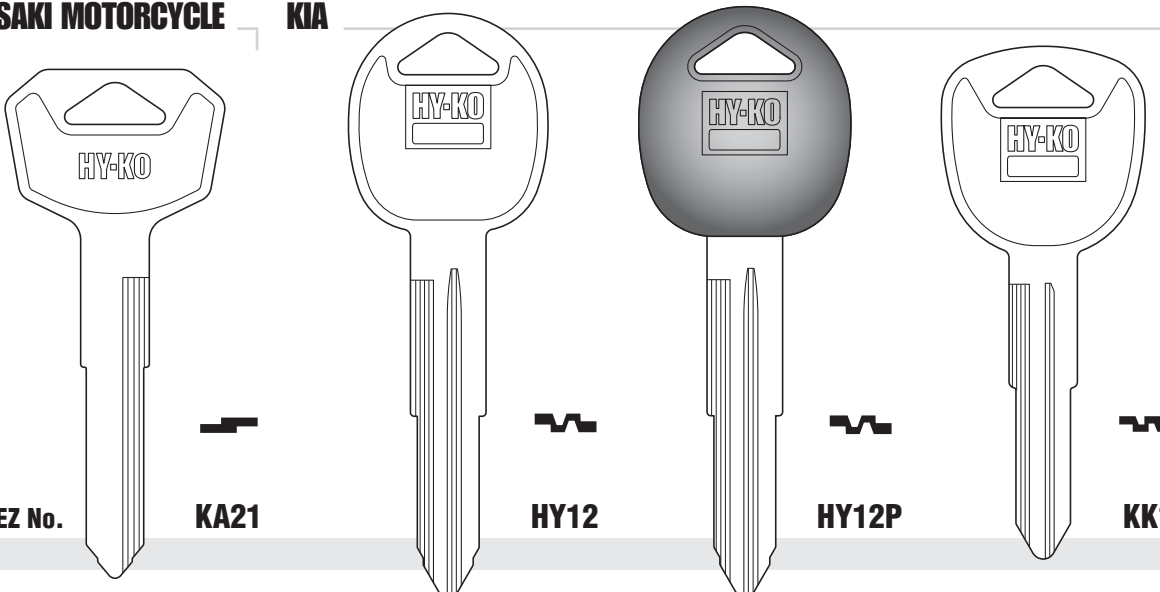

Hy-Ko EZ No. **KA21** **HY12** **HY12P** **KK1**

KIA

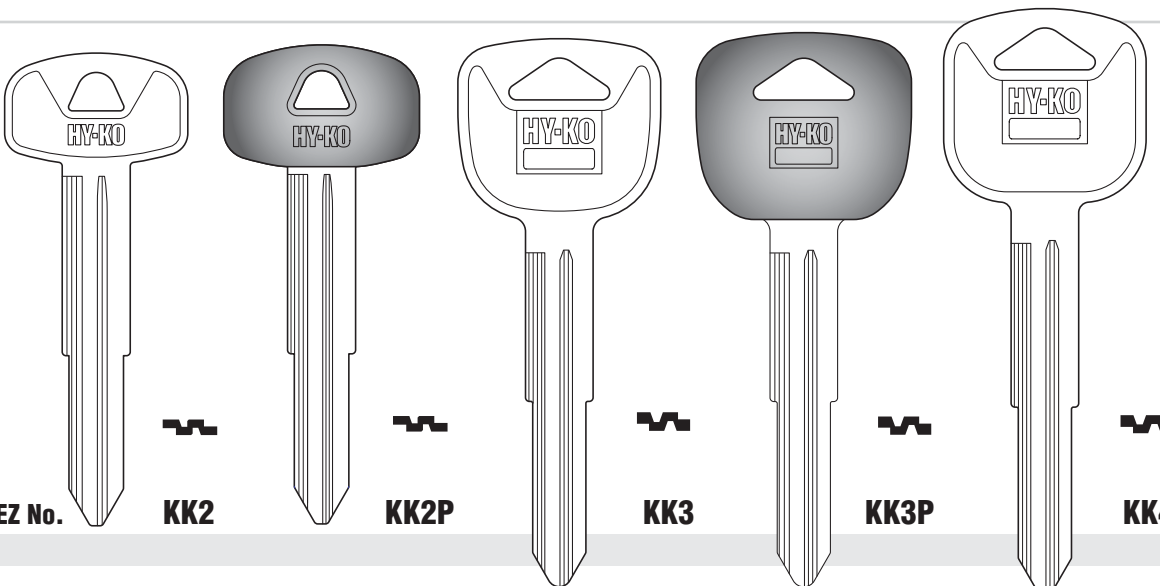

Hy-Ko EZ No. **KK2** **KK2P** **KK3** **KK3P** **KK4**

Finding A Key

1 Look for identification marks on the key head (bow).



(i.e. manufacturer's name, key name, etc.)

2 Ask the customer how the key is used.

3 See reference sections:

- Key Cross Reference pp 76-92

P – Black plastic head
 PC – Color plastic head
 See page 4 for key name explanations

Automotive Keys

KOMATSU

KUBOTA

Identifying A Key

1 Find a key similar in size, key head shape, and millings.

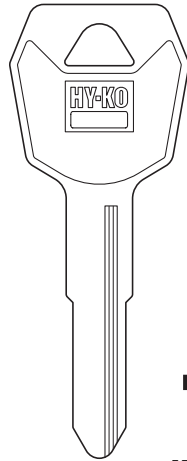
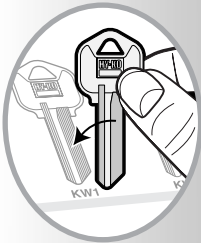

Hy-Ko EZ No.

KOM1



KUB1

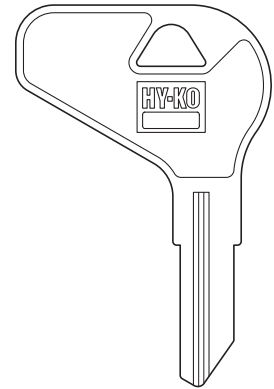

KUB2

LAMBORGHINI

LAND ROVER

See **VOLKSWAGEN** Automotive on pg 45

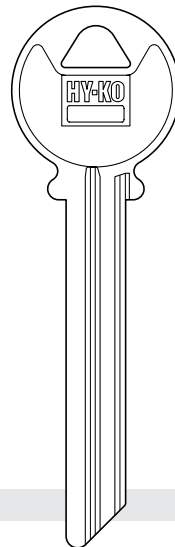

RV1

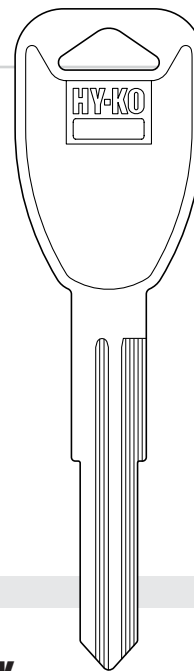

RV4

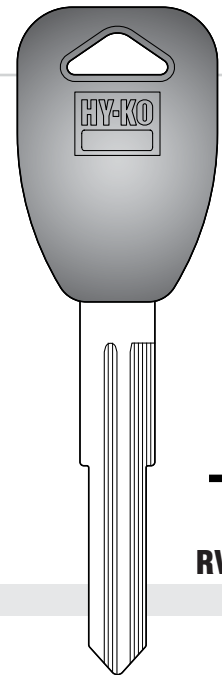

RV4P

LEXUS

LINCOLN

MACK TRUCK

See **TOYOTA** Automotive on pg 42

See **FORD** Automotive on pg 10

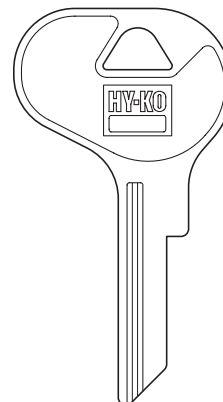

NE10

Hy-Ko EZ No.

2 Raise key vertically on its tip and place on the key cross section.

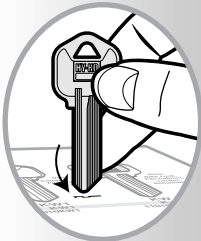

3 Match the grooves of the key to the keyway.

MAZDA

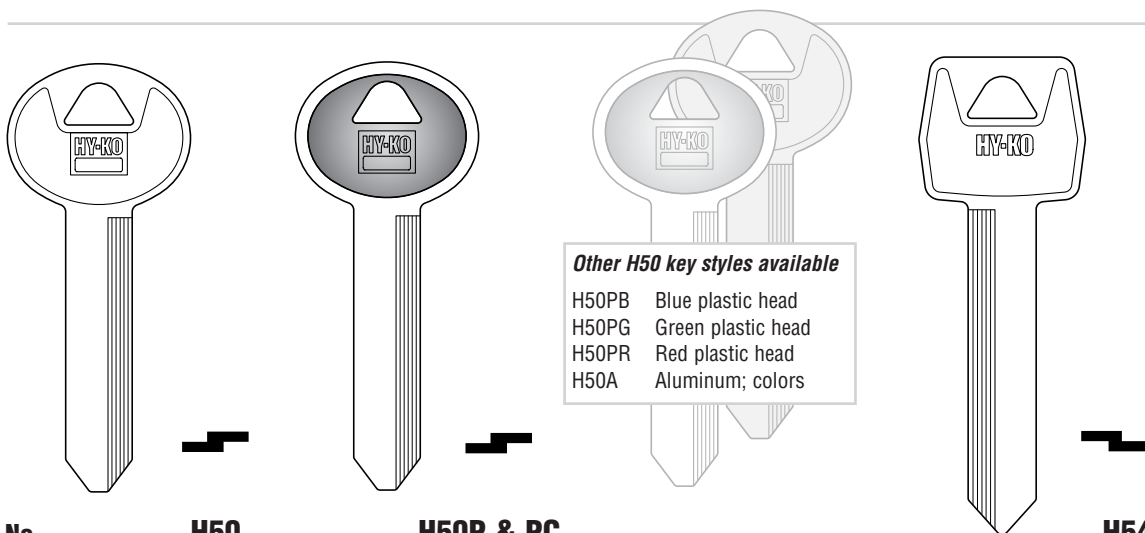

Other H50 key styles available
 H50PB Blue plastic head
 H50PG Green plastic head
 H50PR Red plastic head
 H50A Aluminum; colors

Hy-Ko EZ No.

H50

H50P & PC

H54

MAZDA

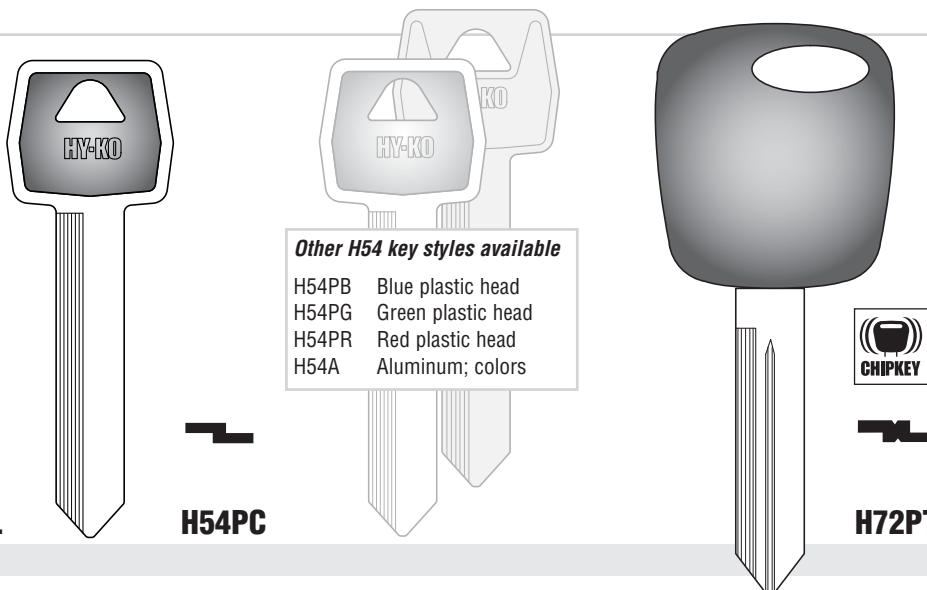

Other H54 key styles available
 H54PB Blue plastic head
 H54PG Green plastic head
 H54PR Red plastic head
 H54A Aluminum; colors

Hy-Ko EZ No.

H54PC

H72PT

MAZDA



Hy-Ko EZ No.

H72PTW

Finding A Key

1 Look for identification marks on the key head (bow).



(i.e. manufacturer's name, key name, etc.)

2 Ask the customer how the key is used.

3 See reference sections:

- Key Cross Reference pp 76-92

P – Black plastic head
 PC – Color plastic head
 See page 4 for key name explanations

Automotive Keys

MAZDA

Identifying A Key

1 Find a key similar in size, key head shape, and millings.

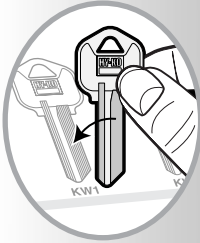

2 Raise key vertically on its tip and place on the key cross section.

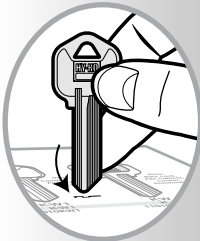

3 Match the grooves of the key to the keyway.

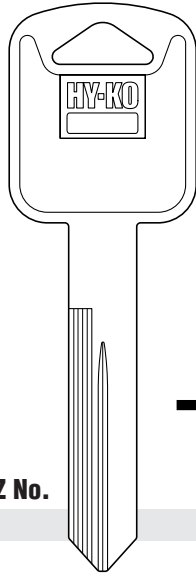

Hy-Ko EZ No.

H75

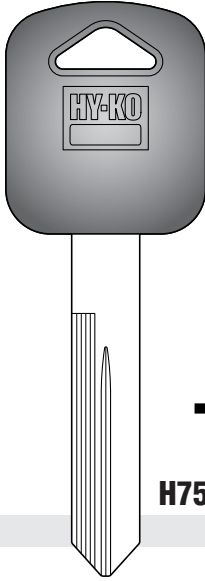

H75P&PC

Other H75 key styles available
 H75PB Blue plastic head
 H75PG Green plastic head
 H75PR Red plastic head

- H75PB Blue plastic head
- H75PG Green plastic head
- H75PR Red plastic head

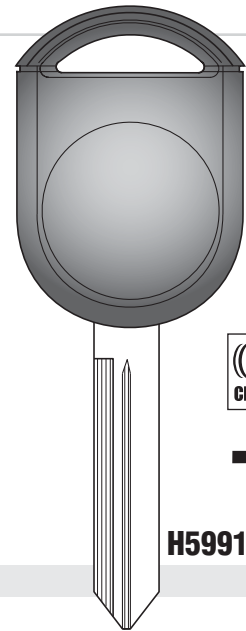

H599114PT



MAZDA

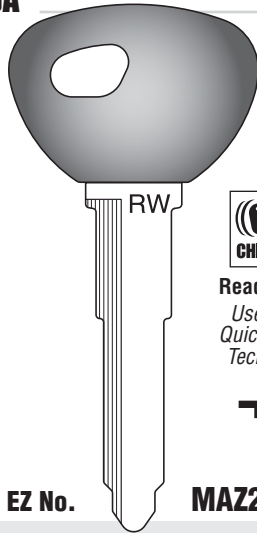

Hy-Ko EZ No.

MAZ24PTW



Read/Write
 Use with
 Quick-Code
 Tech Tool

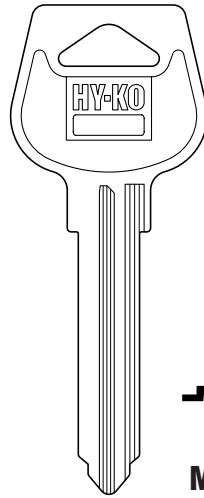

MZ4

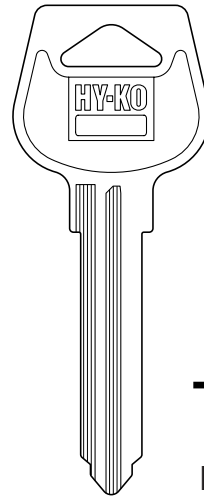

MZ5

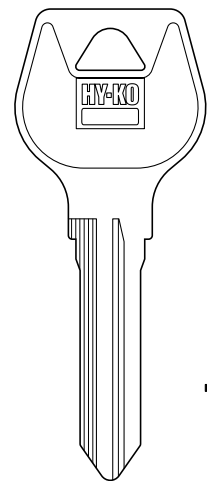

MZ9

MAZDA

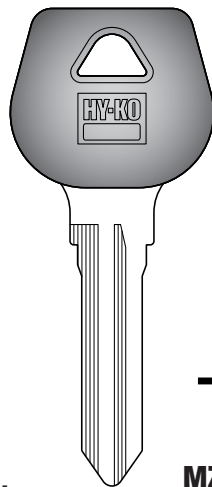

Hy-Ko EZ No.

MZ9P

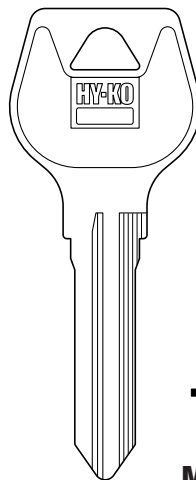

MZ10

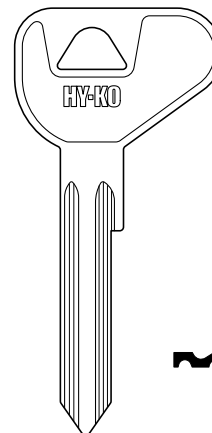

MZ12

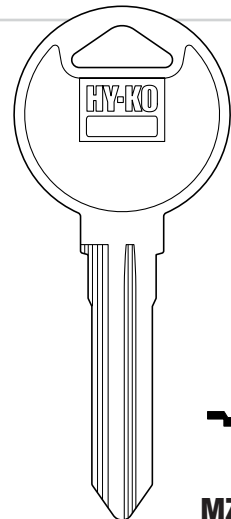

MZ13

MAZDA

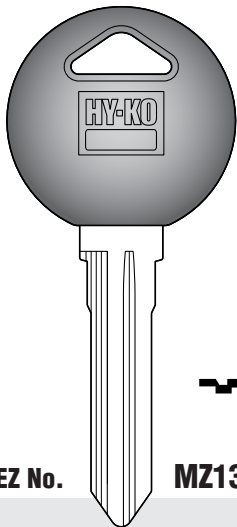

Hy-Ko EZ No. **MZ13P**

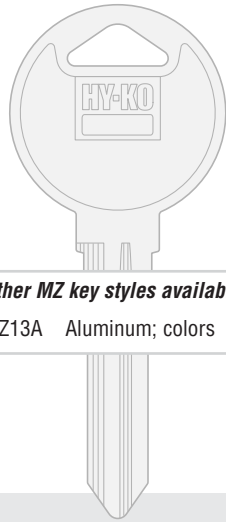

Other MZ key styles available
MZ13A Aluminum; colors

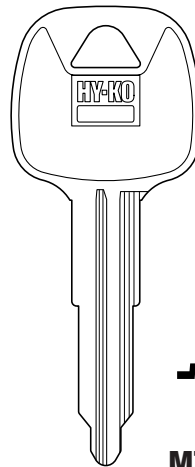

MZ14

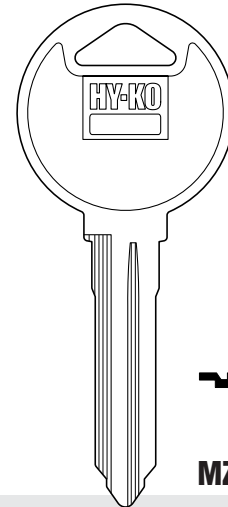

MZ16

MAZDA

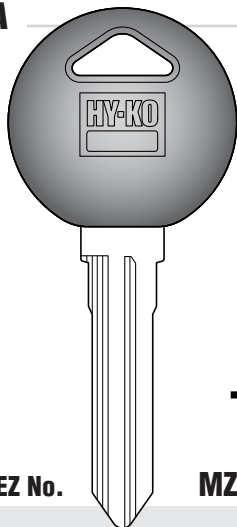

Hy-Ko EZ No. **MZ16P**

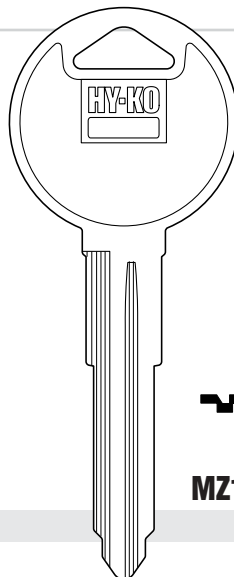

MZ17

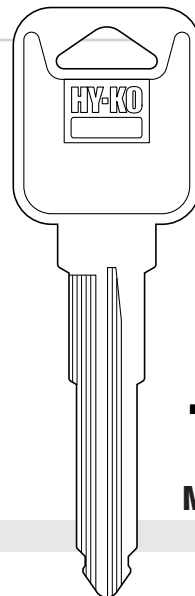

MZ19

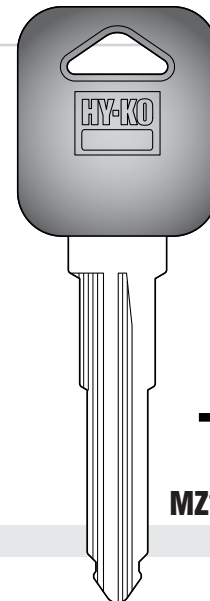

MZ19P

MAZDA

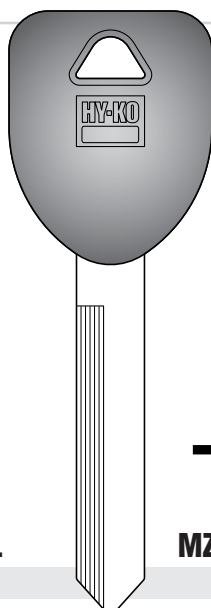

Hy-Ko EZ No. **MZ25P**

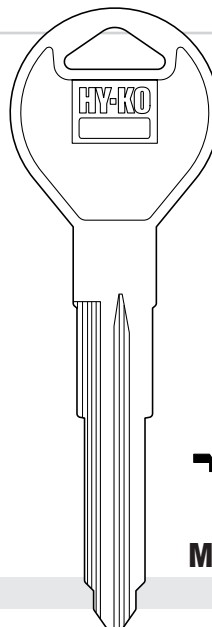

MZ27

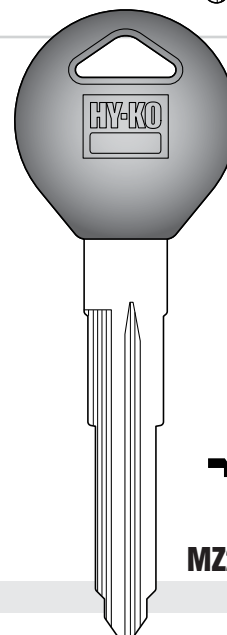

MZ27P

Finding A Key

1 Look for identification marks on the key head (bow).



(i.e. manufacturer's name, key name, etc.)

2 Ask the customer how the key is used.

3 See reference sections:

• Key Cross Reference pp 76-92

P – Black plastic head
PC – Color plastic head
See page 4 for key name explanations

Automotive Keys

MAZDA

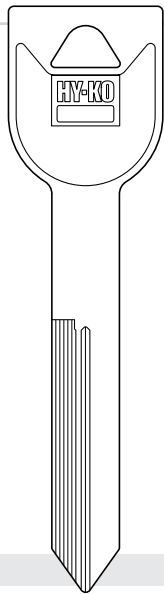

MZ30

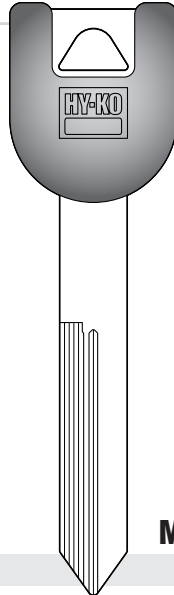

MZ30P

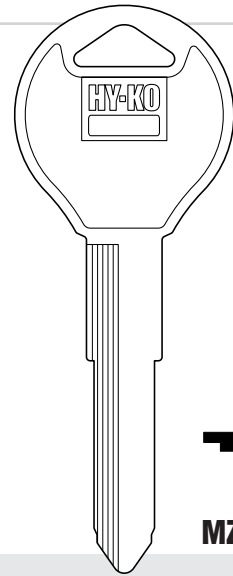

MZ31

Hy-Ko EZ No.

Identifying A Key

1

Find a key similar in size, key head shape, and millings.

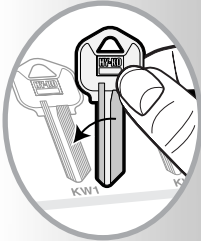

2

Raise key vertically on its tip and place on the key cross section.

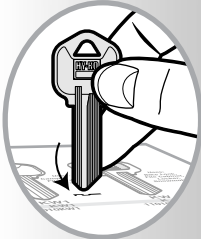

3

Match the grooves of the key to the keyway.

MERCEDES-BENZ

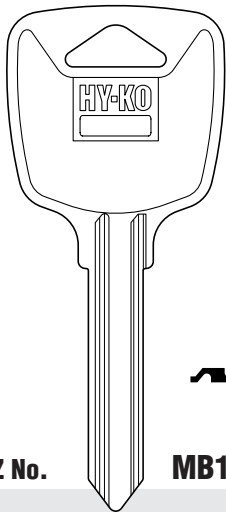

MB16

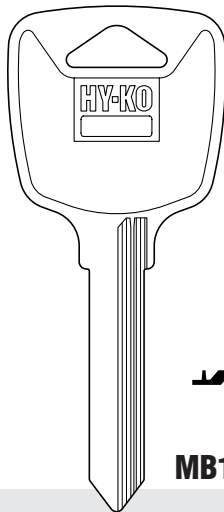

MB18

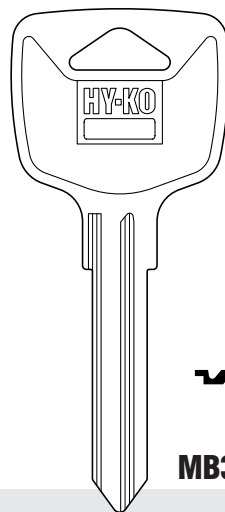

MB34

Hy-Ko EZ No.

MERCURY

See FORD Automotive on pg 10

MITSUBISHI

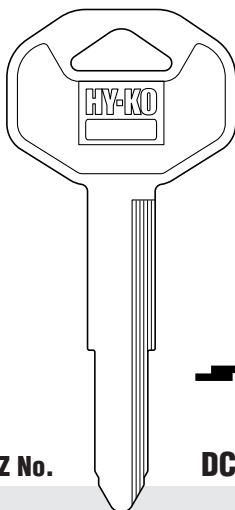

DC3

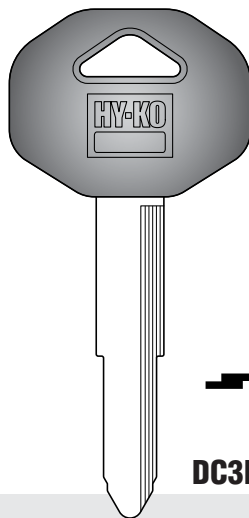

DC3P

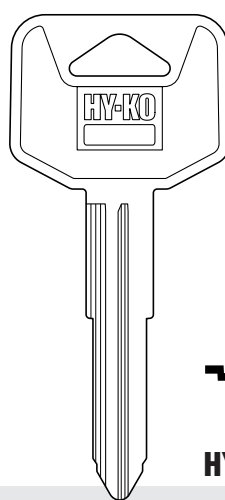

HY2

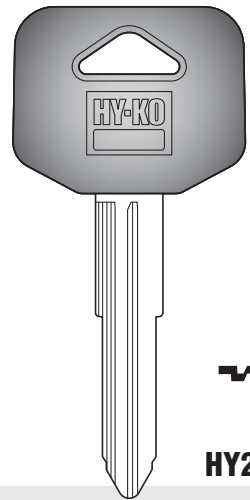

HY2P

Hy-Ko EZ No.

mitsubishi

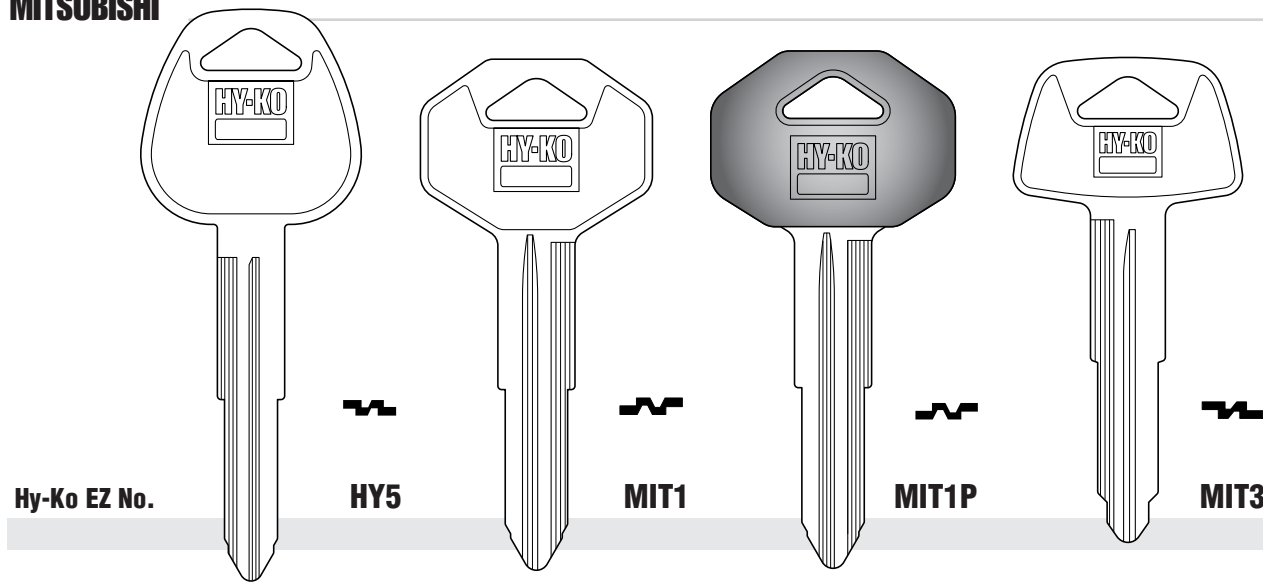

Hy-Ko EZ No.

HY5

MIT1

MIT1P

MIT3

mitsubishi

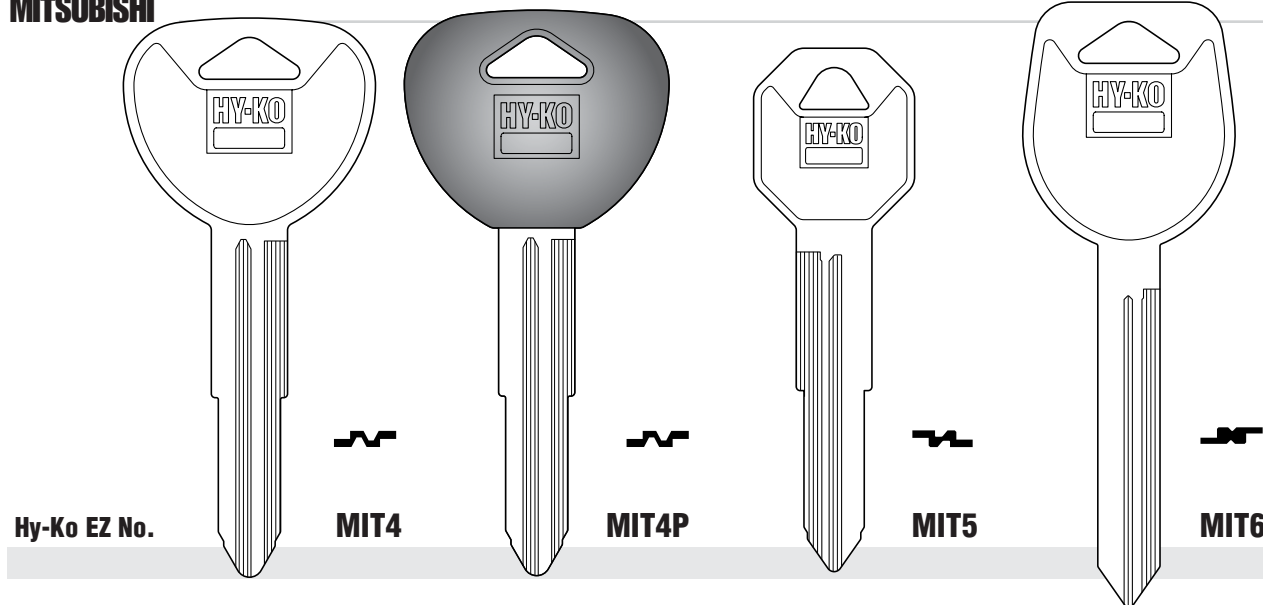

Hy-Ko EZ No.

MIT4

MIT4P

MIT5

MIT6

mitsubishi

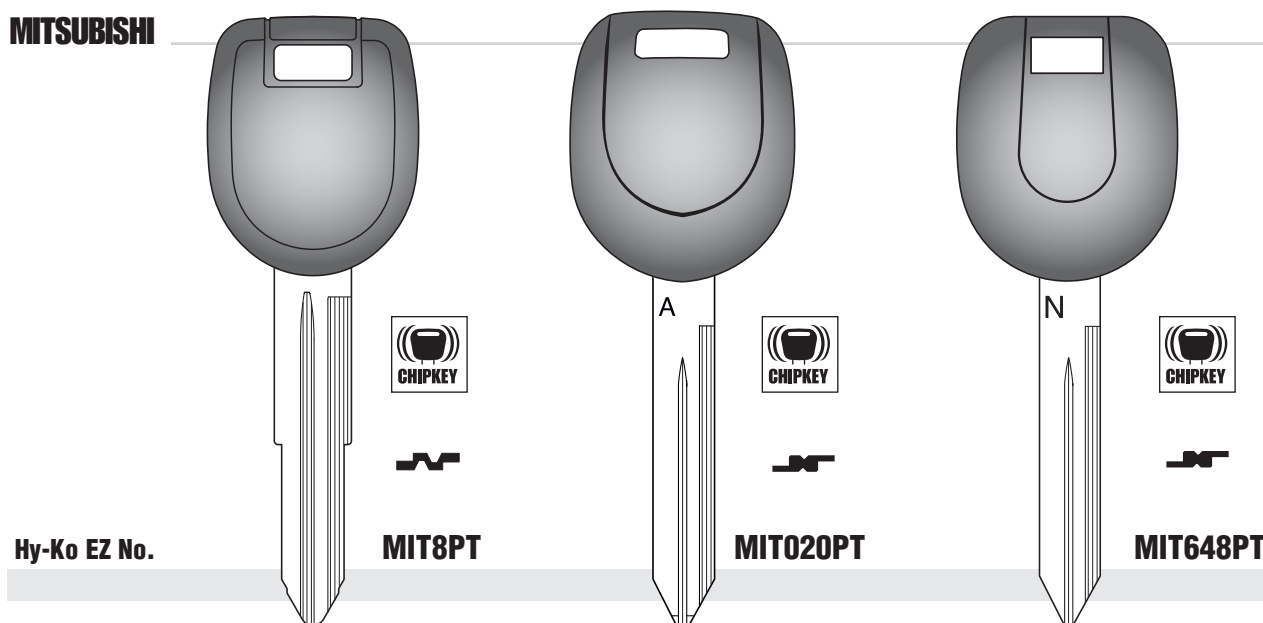

Hy-Ko EZ No.

MIT8PT

MIT20PT

MIT648PT

Finding A Key

1 Look for identification marks on the key head (bow).



(i.e. manufacturer's name, key name, etc.)

2 Ask the customer how the key is used.

3 See reference sections:

- Key Cross Reference pp 76-92

P – Black plastic head
 PC – Color plastic head
 See page 4 for key name explanations

Automotive Keys

NISSAN (Includes DATSUN & INFINITI)

Identifying A Key

1 Find a key similar in size, key head shape, and millings.

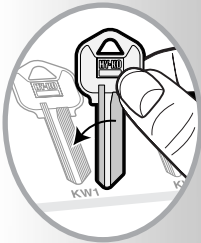

2 Raise key vertically on its tip and place on the key cross section.

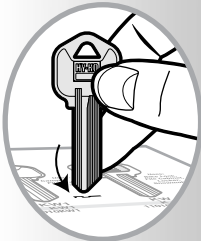

3 Match the grooves of the key to the keyway.

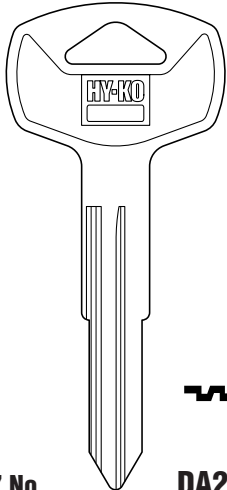

Hy-Ko EZ No.

DA21

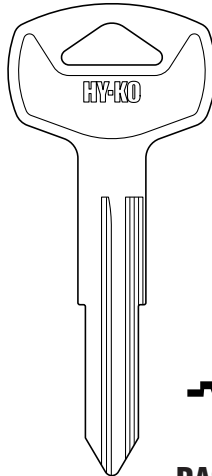

DA22

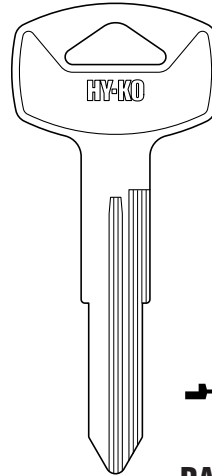

DA23

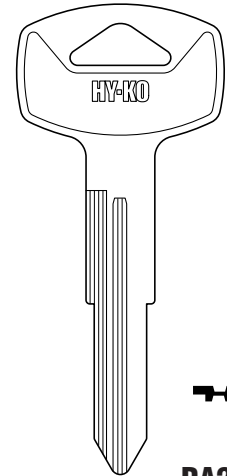

DA24



NISSAN

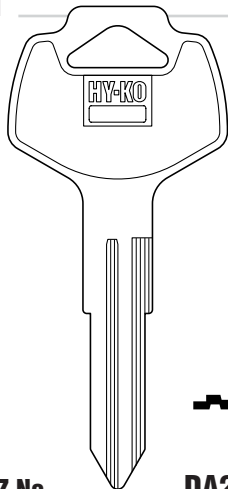

Hy-Ko EZ No.

DA25

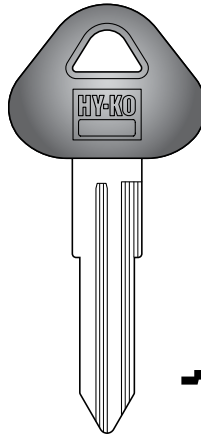

DA25P & PC

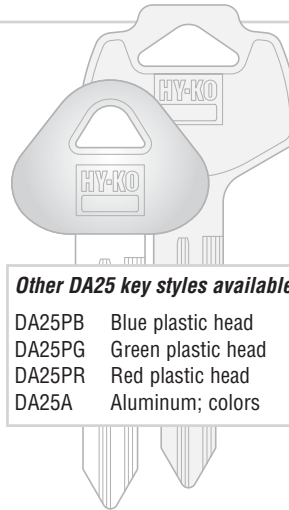

DA28



Other DA25 key styles available

- DA25PB Blue plastic head
- DA25PG Green plastic head
- DA25PR Red plastic head
- DA25A Aluminum; colors

NISSAN

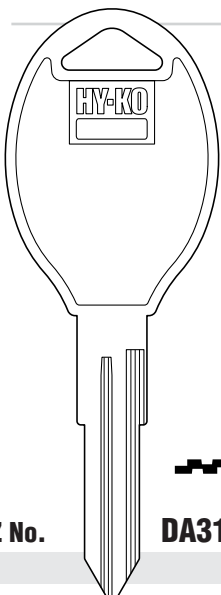

Hy-Ko EZ No.

DA31

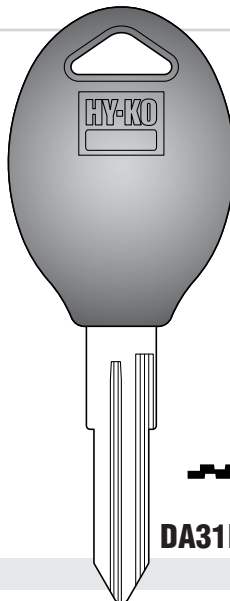

DA31P



Other DA31 key styles available

- DA31A Aluminum; colors

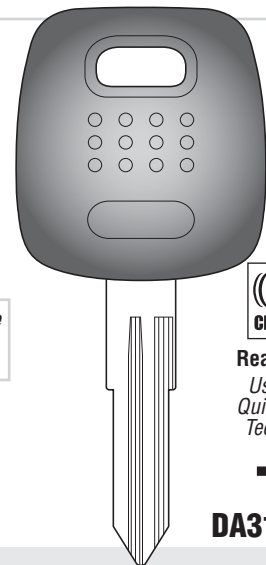

DA31PTW



Read/Write
Use with
Quick-Code
Tech Tool



NISSAN

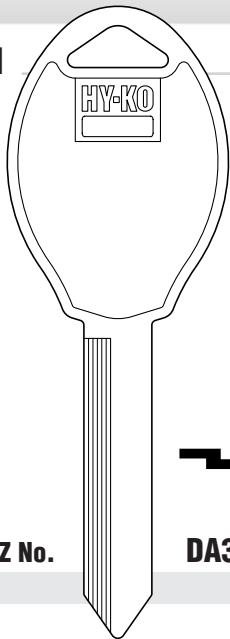

Hy-Ko EZ No.

DA32

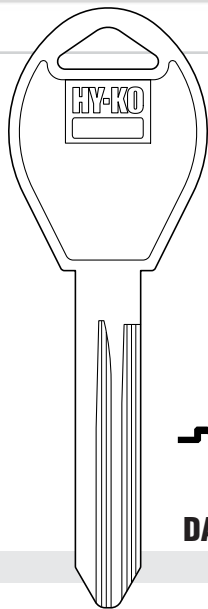

DA34

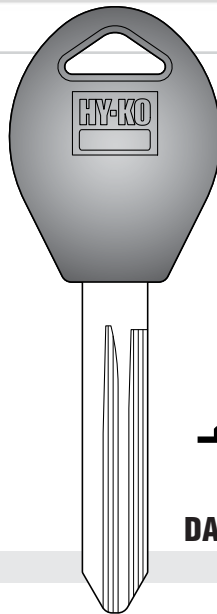

DA34P

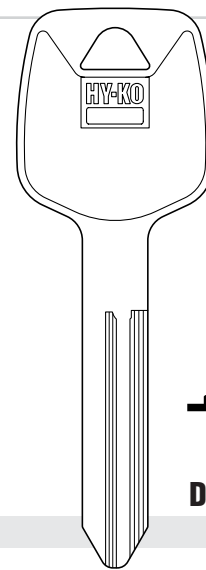

DA35

NISSAN

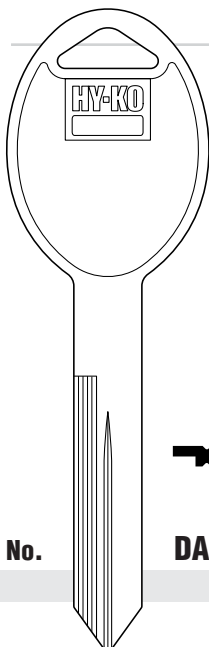

Hy-Ko EZ No.

DA37

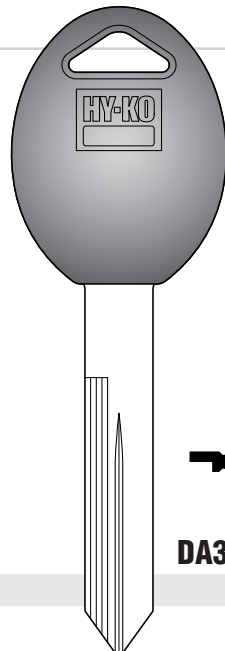

DA37P

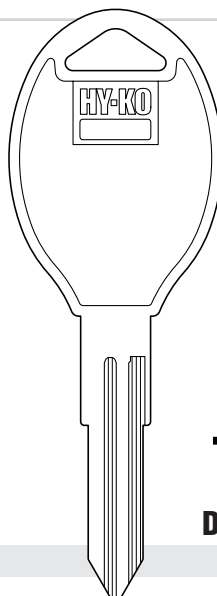

DA38

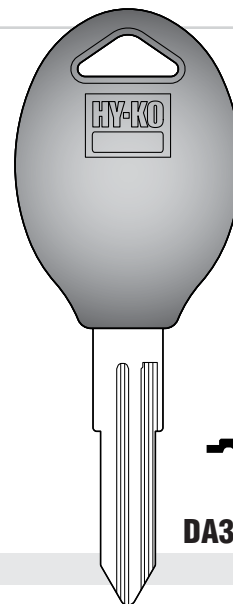

DA38P

NISSAN

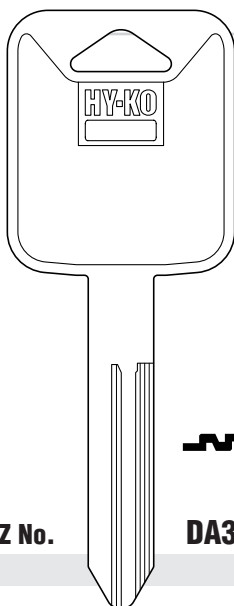

Hy-Ko EZ No.

DA39

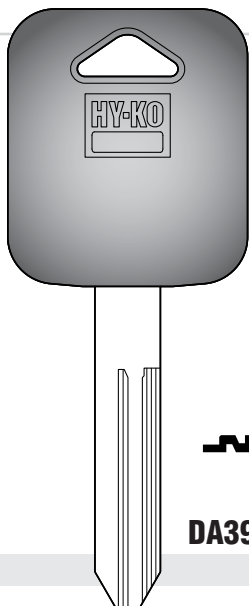

DA39P



Finding A Key

1 Look for identification marks on the key head (bow).



(i.e. manufacturer's name, key name, etc.)

2 Ask the customer how the key is used.

3 See reference sections:

- Key Cross Reference pp 76-92

P – Black plastic head
 PC – Color plastic head
 See page 4 for key name explanations

Automotive Keys

NISSAN

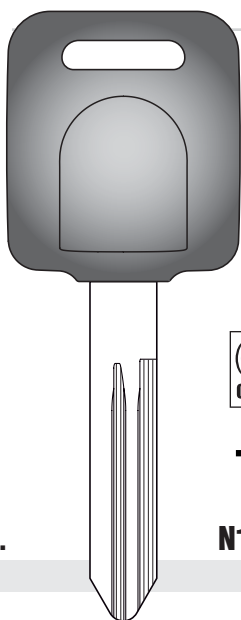

Hy-Ko EZ No. **N101PT**

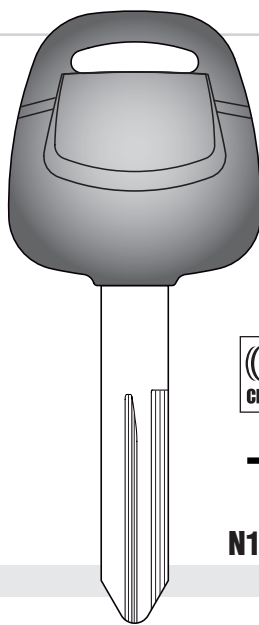

Hy-Ko EZ No. **N102PT**

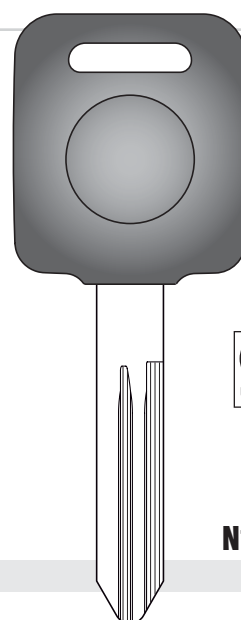

Hy-Ko EZ No. **N104PT**

Identifying A Key

1 Find a key similar in size, key head shape, and millings.

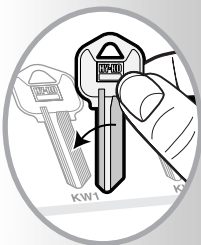

OLDSMOBILE

See **GENERAL MOTORS Automotive** on pg 15

Hy-Ko EZ No.

PLYMOUTH

See **CHRYSLER Automotive** on pg 7

PONTIAC

See **GENERAL MOTORS Automotive** on pg 15

SAAB

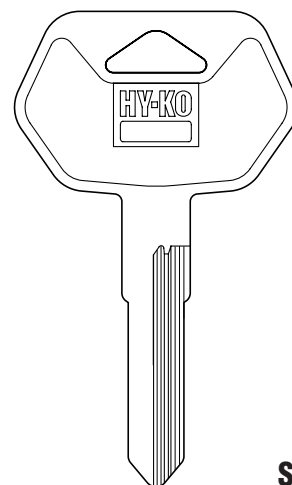

Hy-Ko EZ No. **SAA1**

2 Raise key vertically on its tip and place on the key cross section.

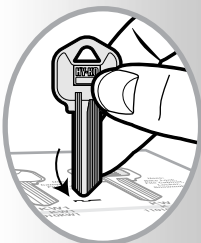

SAAB

3 Match the grooves of the key to the keyway.

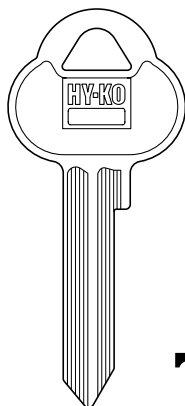

Hy-Ko EZ No.

SB11

SATURN

See **GENERAL MOTORS Automotive** on pg 15

SUBARU

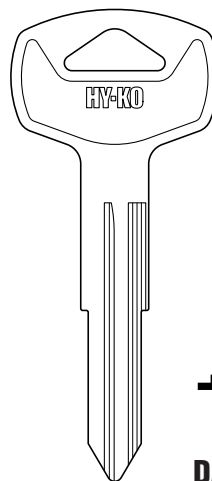

Hy-Ko EZ No. **DA22**

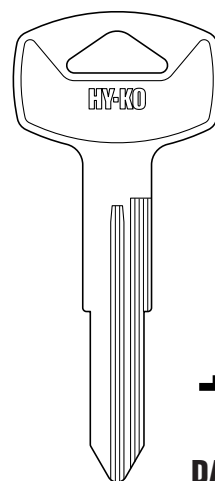

Hy-Ko EZ No. **DA23**

SUBARU

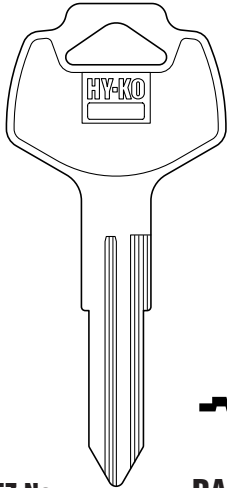

DA25

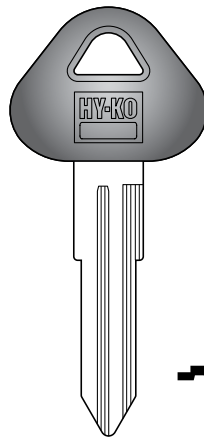

DA25P & PC

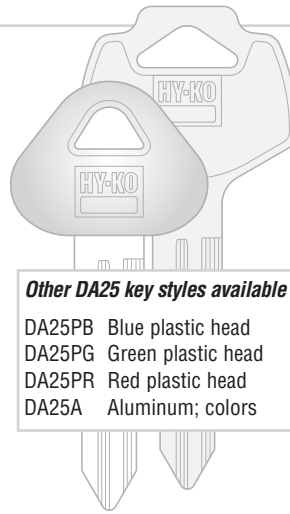

Other DA25 key styles available

- DA25PB Blue plastic head
- DA25PG Green plastic head
- DA25PR Red plastic head
- DA25A Aluminum; colors

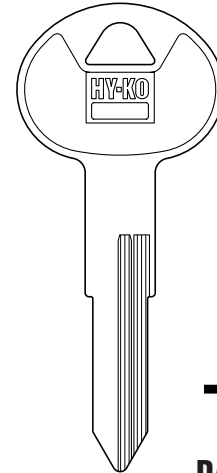

DA28

Hy-Ko EZ No.

SUBARU

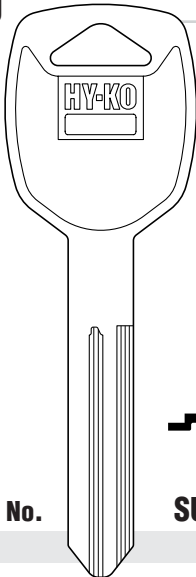

SUB1

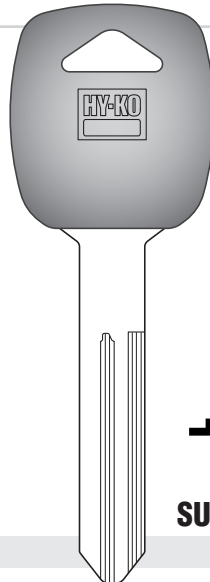

SUB1P

SUZUKI

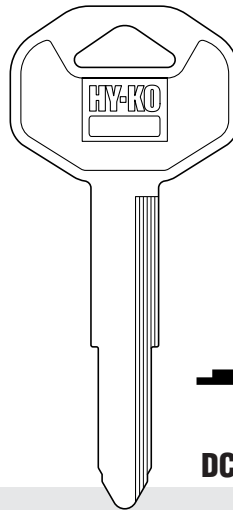

DC3

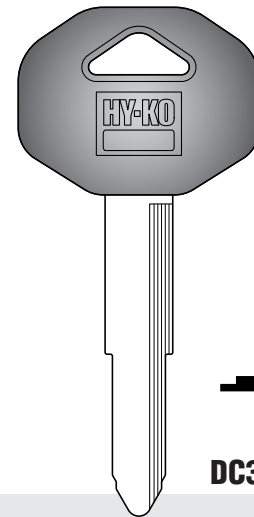

DC3P

Hy-Ko EZ No.

SUZUKI

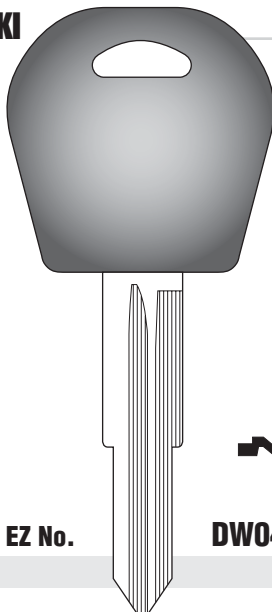

DW04RP

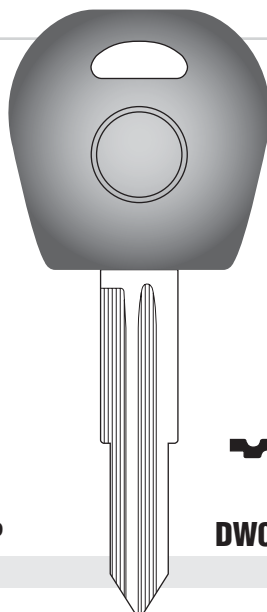

DW05P

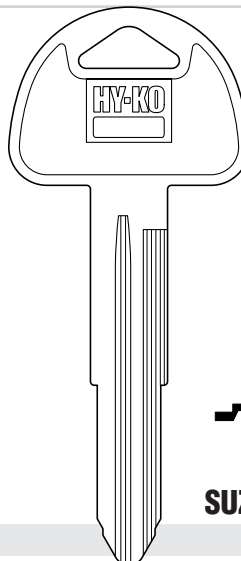

SUZ15

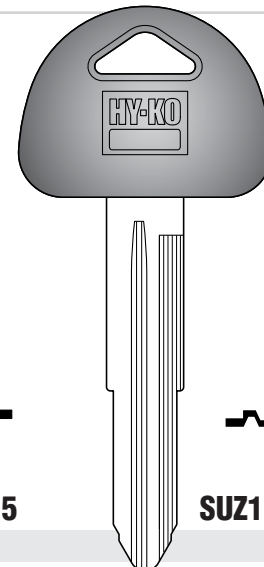

SUZ15P

Hy-Ko EZ No.

Finding A Key

1 Look for identification marks on the key head (bow).



(i.e. manufacturer's name, key name, etc.)

2 Ask the customer how the key is used.

3 See reference sections:

- Key Cross Reference pp 76-92

P – Black plastic head
 PC – Color plastic head
 See page 4 for key name explanations

Automotive Keys

SUZUKI

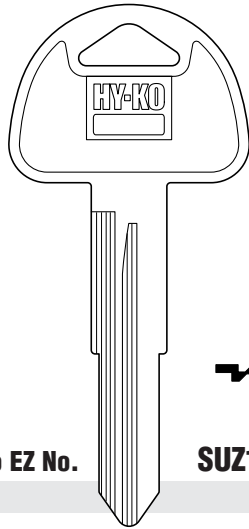

Hy-Ko EZ No.

SUZ17

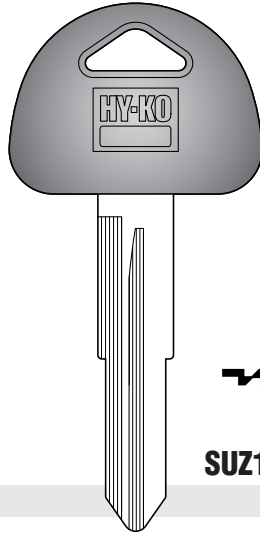

SUZ17P

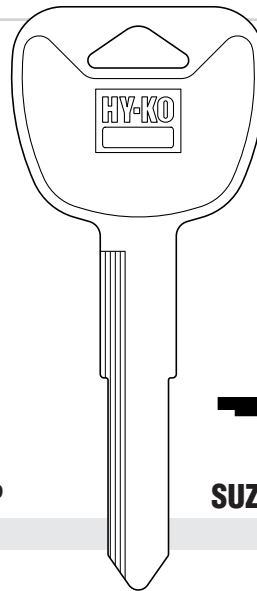

SUZ20

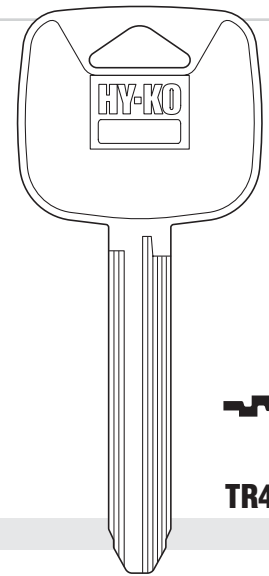

TR47



Identifying A Key

1 Find a key similar in size, key head shape, and millings.

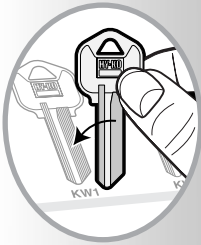

SUZUKI

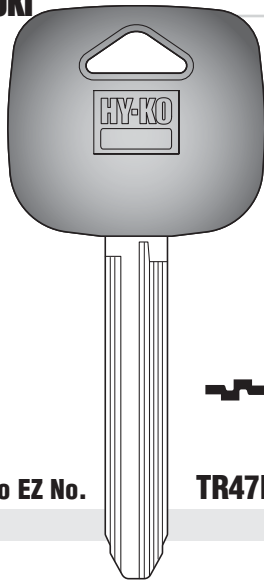

Hy-Ko EZ No.

TR47P & PC

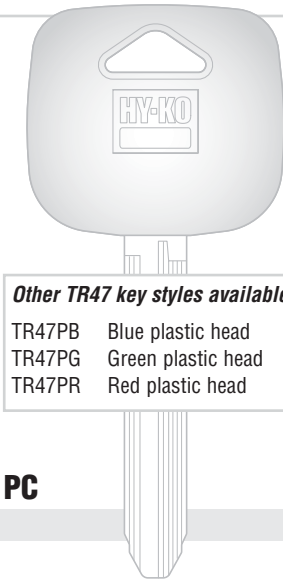

Other TR47 key styles available

- TR47PB Blue plastic head
- TR47PG Green plastic head
- TR47PR Red plastic head

SUZUKI MOTORCYCLE

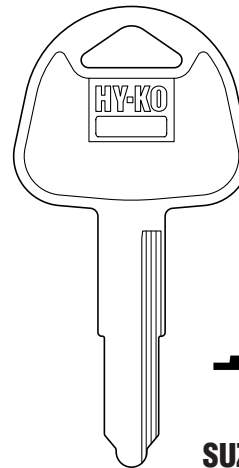

SUZ11

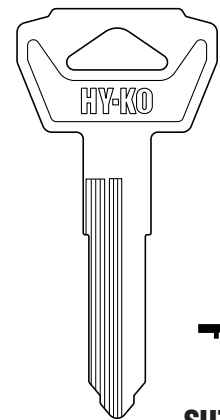

SUZ12



SUZUKI MOTORCYCLE

TRIUMPH MOTORCYCLE

TOYOTA (Includes LEXUS, SCION)

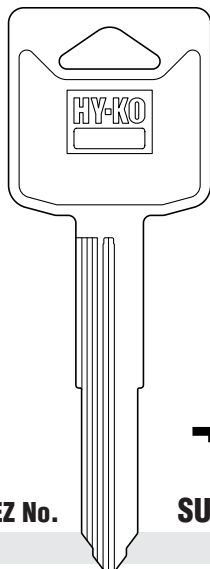

Hy-Ko EZ No.

SUZ18

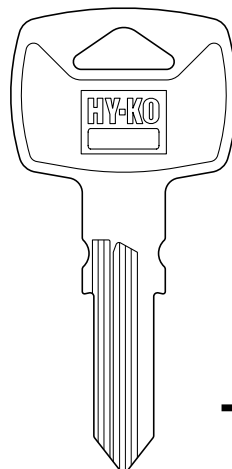

TMP1

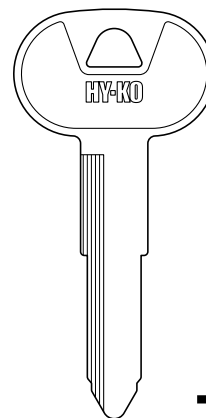

B56

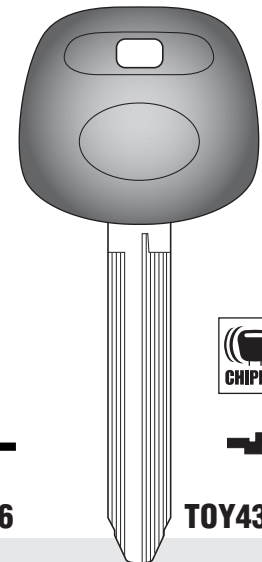

TOY43PT



2 Raise key vertically on its tip and place on the key cross section.

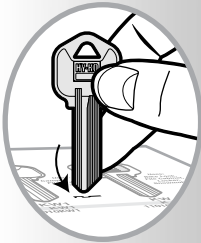

3 Match the grooves of the key to the keyway.

TOYOTA

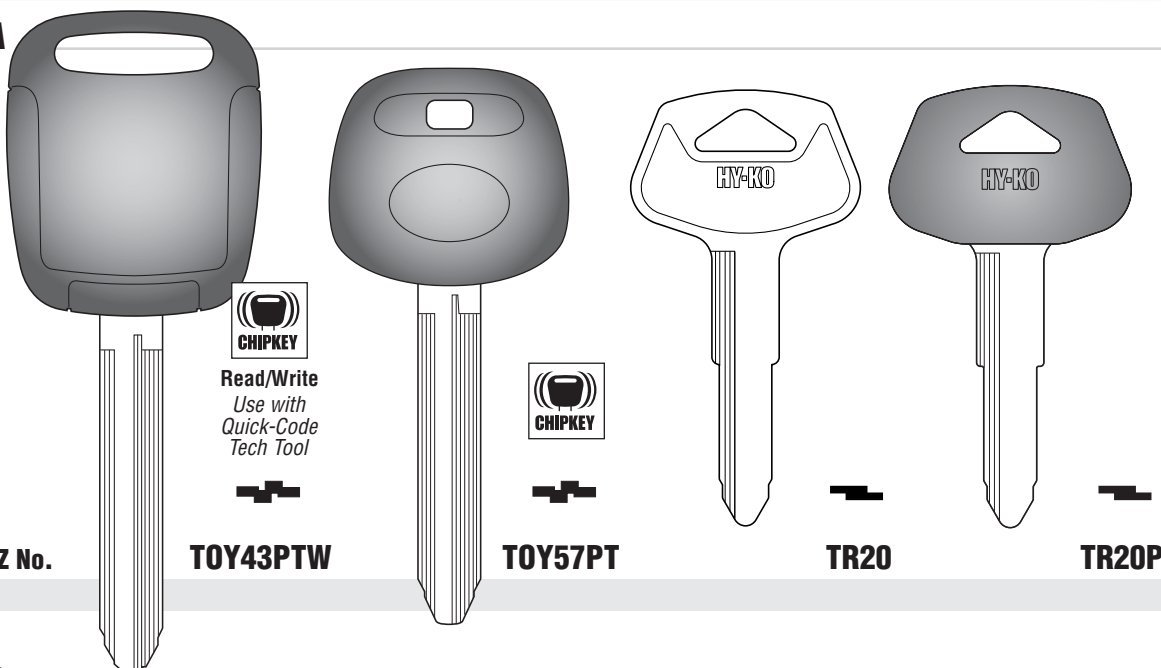

Hy-Ko EZ No.

TOY43PTW

TOY57PT

TR20

TR20P

TOYOTA

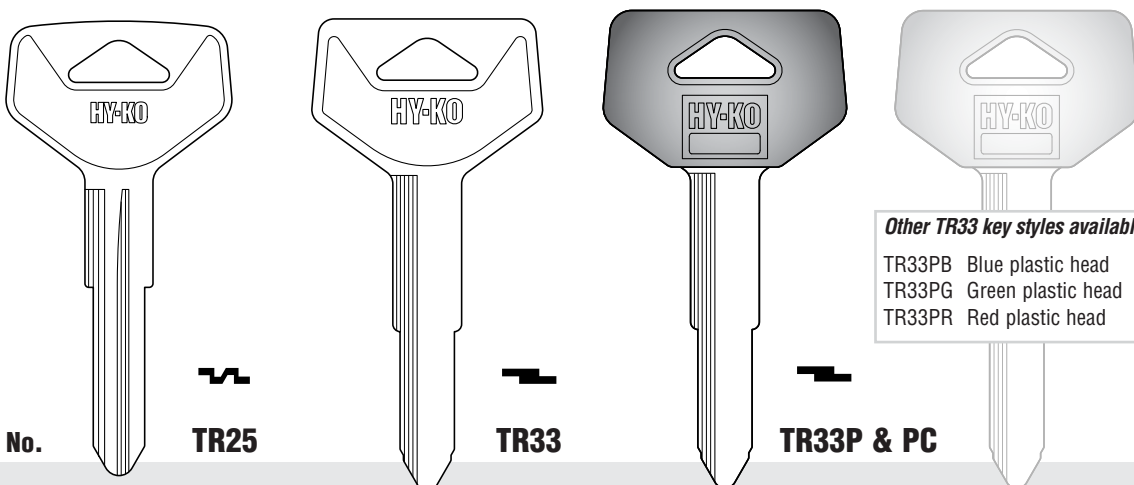

Hy-Ko EZ No.

TR25

TR33

TR33P & PC

Other TR33 key styles available

TR33PB Blue plastic head
TR33PG Green plastic head
TR33PR Red plastic head

Finding A Key

1 Look for identification marks on the key head (bow).



(i.e. manufacturer's name, key name, etc.)

2 Ask the customer how the key is used.

3 See reference sections:

• Key Cross Reference pp 76-92

TOYOTA

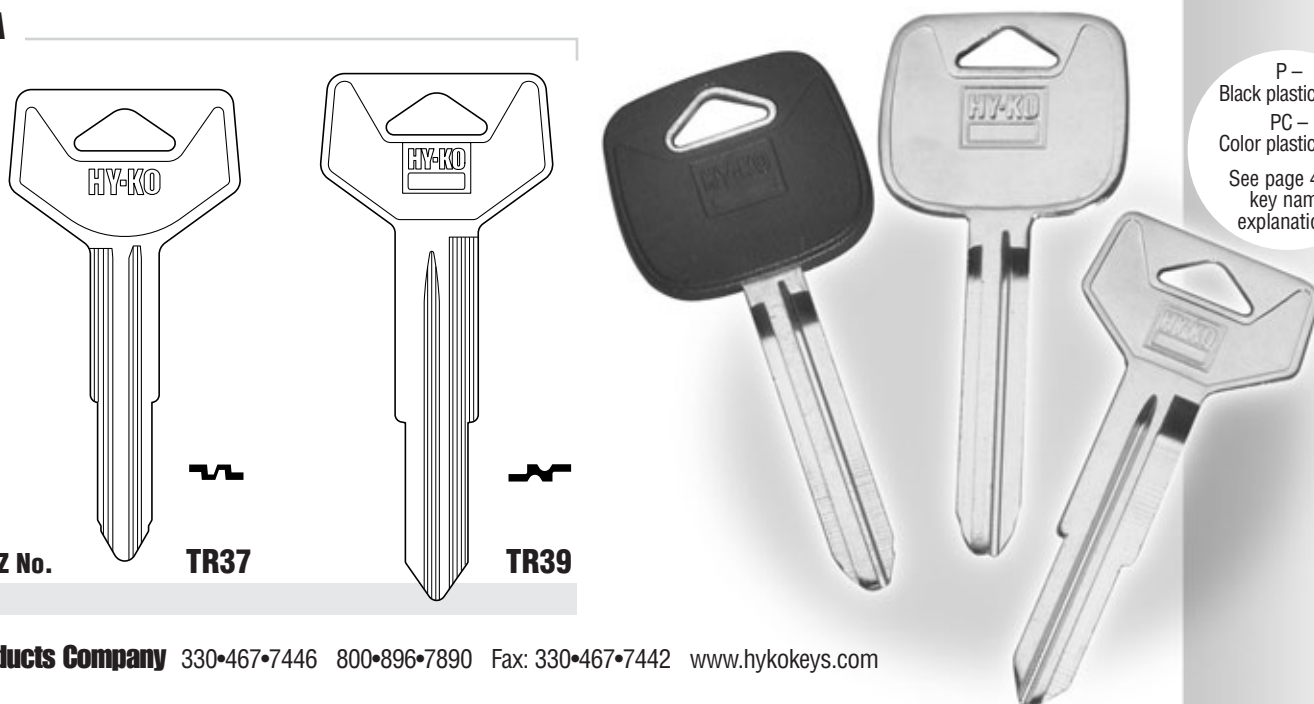

Hy-Ko EZ No.

TR37

TR39

P – Black plastic head
PC – Color plastic head
See page 4 for key name explanations

Automotive Keys

TOYOTA

Identifying A Key

1 Find a key similar in size, key head shape, and millings.

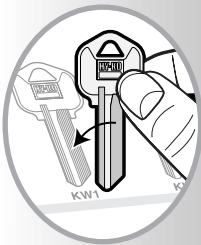

2

Raise key vertically on its tip and place on the key cross section.

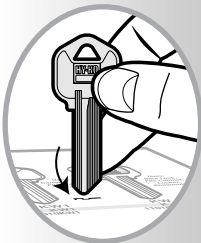

3

Match the grooves of the key to the keyway.

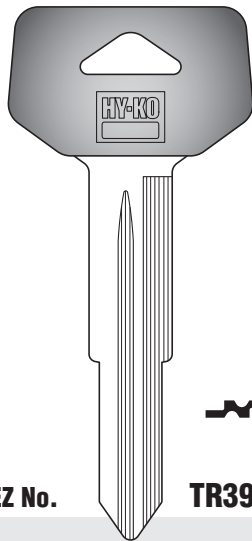

Hy-Ko EZ No.

TR39P

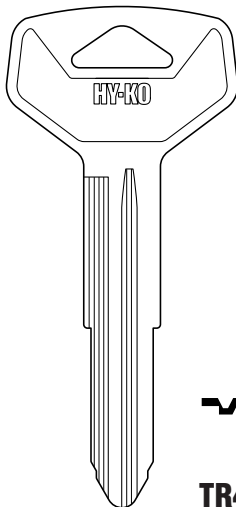

TR40

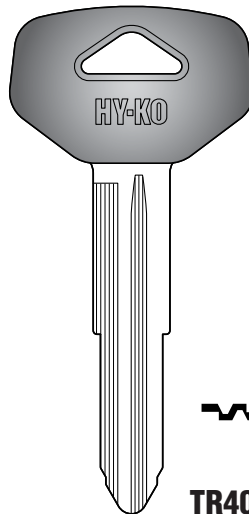

TR40P & PC

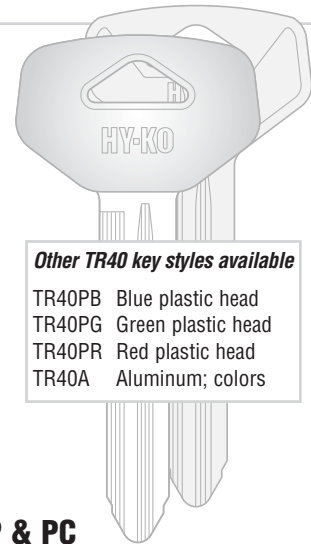

Other TR40 key styles available

- TR40PB Blue plastic head
- TR40PG Green plastic head
- TR40PR Red plastic head
- TR40A Aluminum; colors

TOYOTA

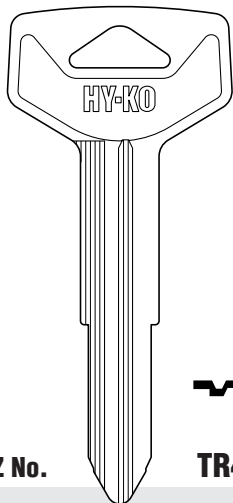

Hy-Ko EZ No.

TR44

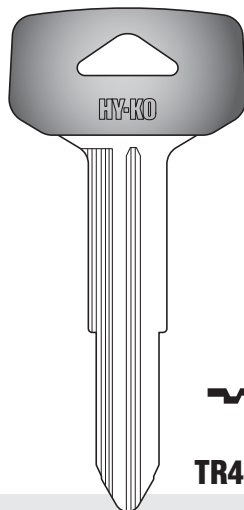

TR44P

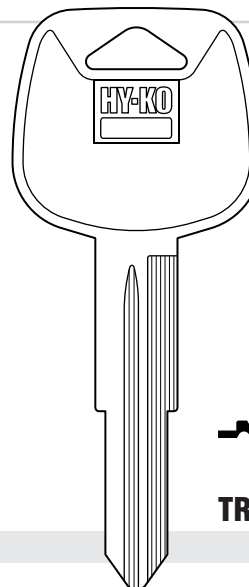

TR46

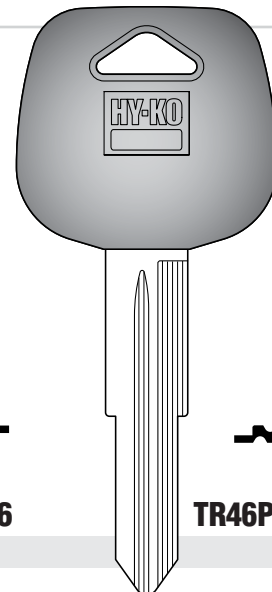

TR46P & PC

TOYOTA

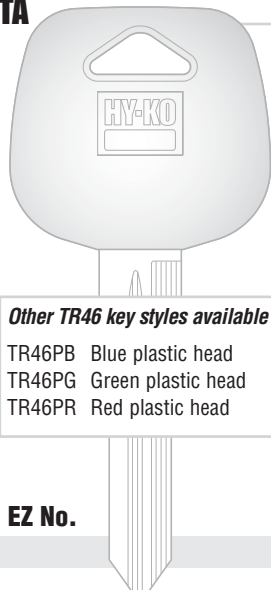

Hy-Ko EZ No.

- Other TR46 key styles available**
- TR46PB Blue plastic head
 - TR46PG Green plastic head
 - TR46PR Red plastic head

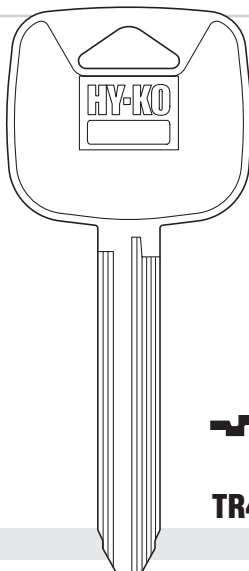

TR47

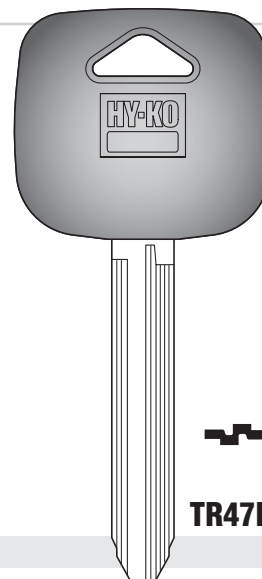

TR47P & PC

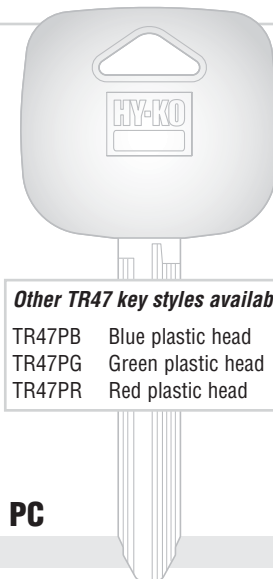

Other TR47 key styles available

- TR47PB Blue plastic head
- TR47PG Green plastic head
- TR47PR Red plastic head

TOYOTA

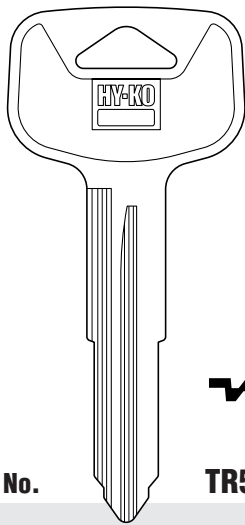

Hy-Ko EZ No.

TR53

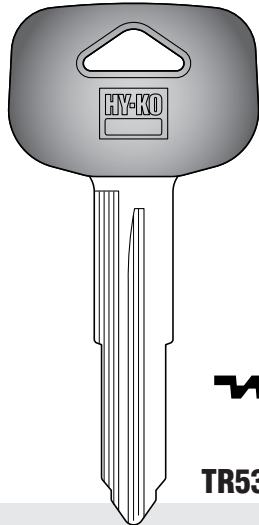

TR53P

TOYOTA FORKLIFT

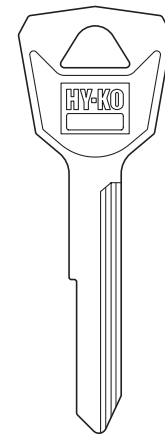

TA6

VOLKSWAGEN (Includes AUDI & LAMBORGHINI)

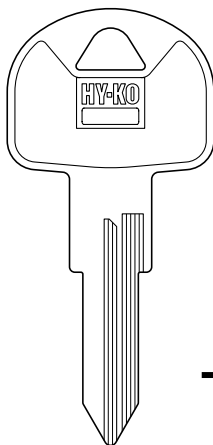

Hy-Ko EZ No.

FT46

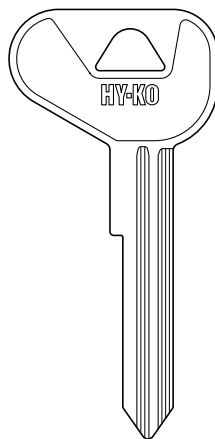

V29

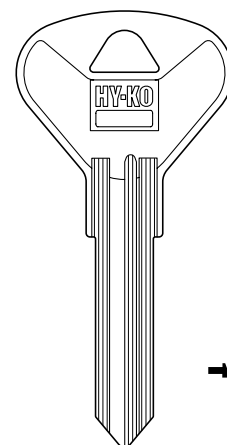

V33

VOLKSWAGEN

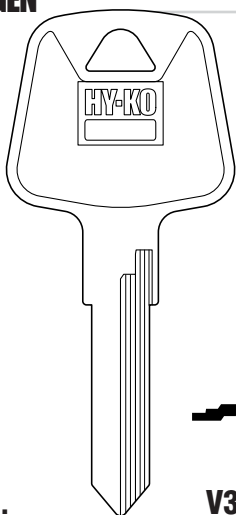

Hy-Ko EZ No.

V35

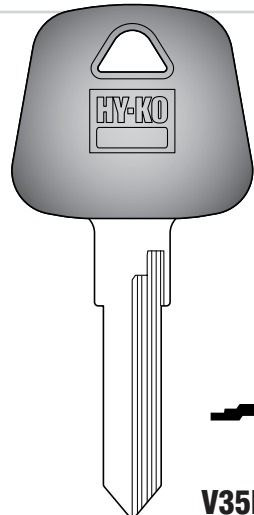

V35P



Finding A Key

1 Look for identification marks on the key head (bow).



(i.e. manufacturer's name, key name, etc.)

2 Ask the customer how the key is used.

3 See reference sections:

- Key Cross Reference pp 76-92

P – Black plastic head
 PC – Color plastic head
 See page 4 for key name explanations

Automotive Keys

VOLKSWAGEN

Identifying A Key

1 Find a key similar in size, key head shape, and millings.

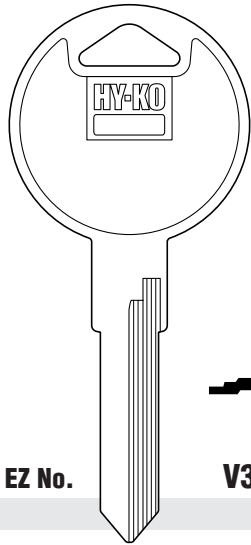

Hy-Ko EZ No.

VW37

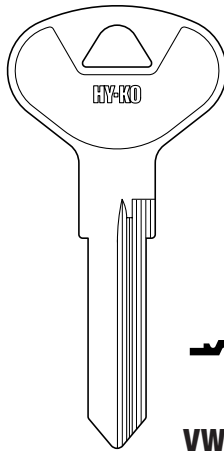

VW23

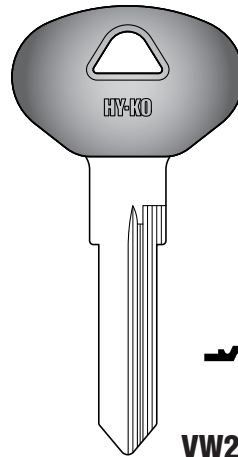

VW23P

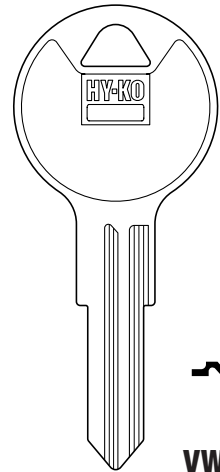

VW32



VOLKSWAGEN

VOLVO

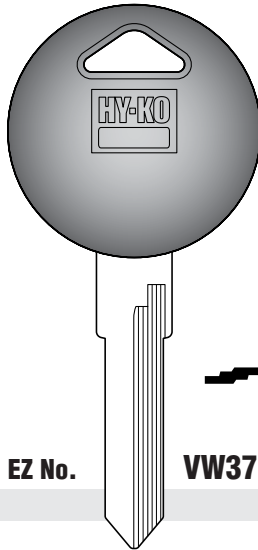

Hy-Ko EZ No.

VW37P

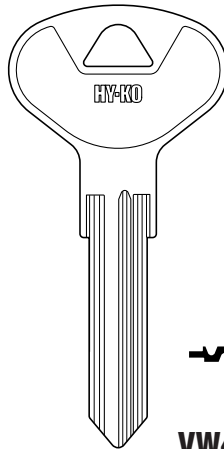

VW42

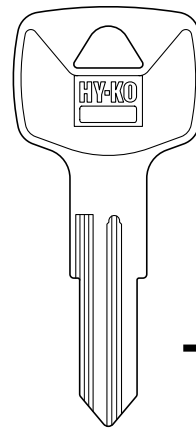

VL4

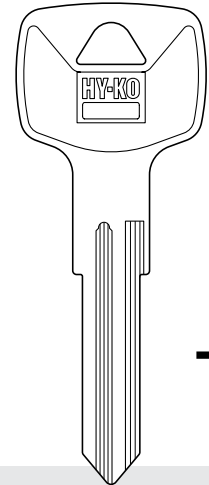

VL5



VOLVO

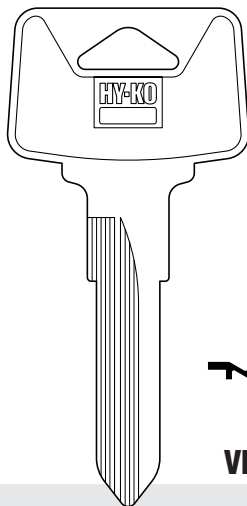

Hy-Ko EZ No.

VL6

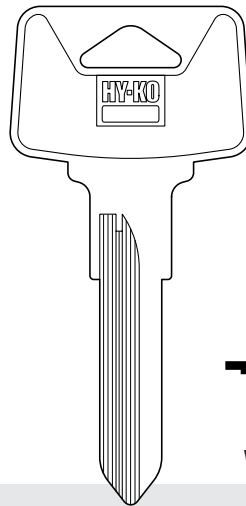

VL8

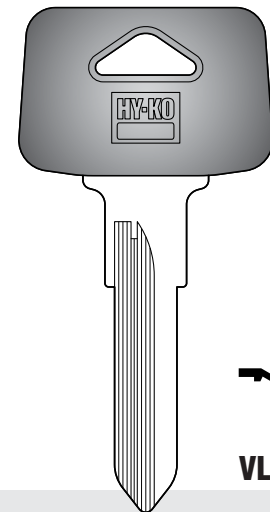

VL8P

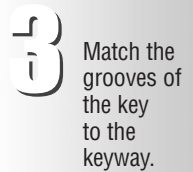
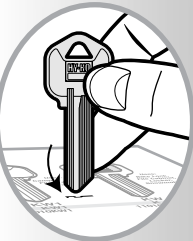
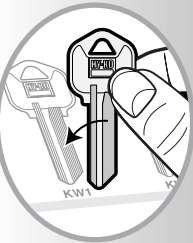

YAMAHA MOTORCYCLE

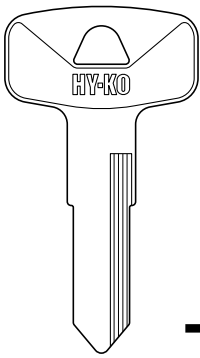

Hy-Ko EZ No. **YH37**

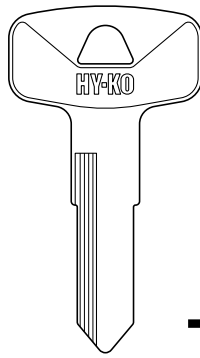

YH38

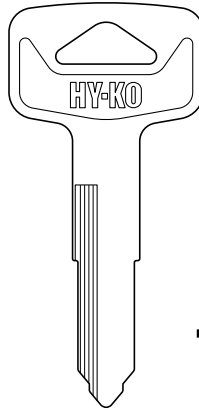

YH46

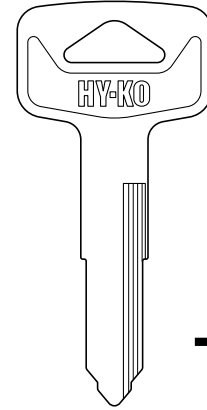

YH47

YAMAHA MOTORCYCLE

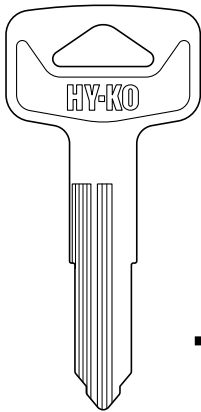

Hy-Ko EZ No. **YH48**

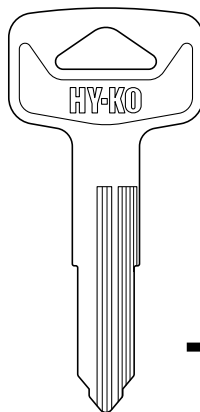

YH49

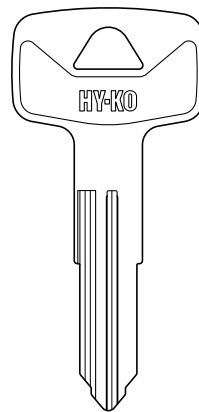

YH50

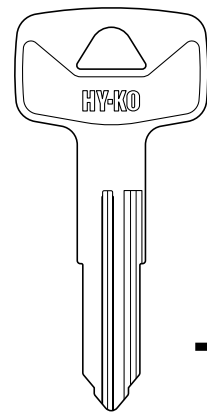

YH51

YAMAHA MOTORCYCLE

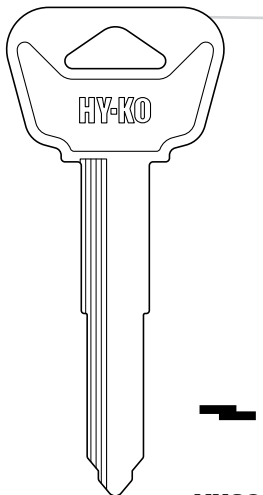

Hy-Ko EZ No. **YH63**



Finding A Key

1 Look for identification marks on the key head (bow).

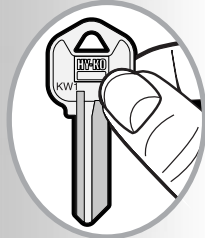

(i.e. manufacturer's name, key name, etc.)

2 Ask the customer how the key is used.

3 See reference sections:

- Key Cross Reference pp 76-92

P – Black plastic head
 PC – Color plastic head
 See page 4 for key name explanations

Automotive Keys

YARD TRACTOR

YUGO

Identifying A Key

1

Find a key similar in size, key head shape, and millings.

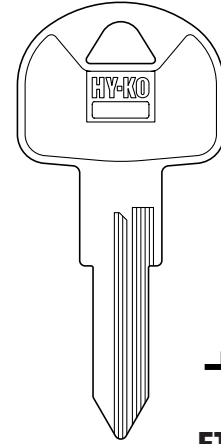

Hy-Ko EZ No.

IH2

YT1

FT46

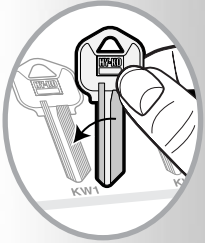

2

Raise key vertically on its tip and place on the key cross section.

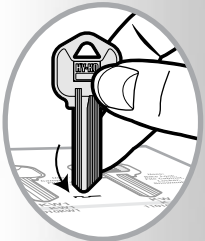

3

Match the grooves of the key to the keyway.