



# Index

## A

**ACRYLIC GLASS**

FLEX-O-GLAZE G108

**ADHESIVE PADS**

FELT G54

**AIR CONDITIONER**

WEATHERSTRIP G146

**AIRCRAFT**

CABLE G166

**AIRCRAFT CABLE G166****ALUMINUM**

SCREEN G109

**ALUMINUM PADLOCKS G44****ALUMINUM SIGNS G126****ANCHOR SHACKLE G162****ARMORED PADLOCKS G42****AWNING**

PULLEY G113, G114

## B

**BACK PACK LOCK G47****BAIL LATCHES G107****BALL CATCH G79****BAR HOLDER**

CLOSED G34

OPEN G34

**BARN**

HARDWARE KIT G34

JAMB LATCH G34

STAY ROLLER G34

**BOLT**

BARREL G96

BRASS DOOR G50

CANE G36

CHAIN G51, G97

FOOT G97

SLIDE G51

SLIDE ACTION G35

SNAPS G20

**BOOT**

SCRUBBER G184

**BOOT DRYER G184****BOOT PRODUCTS G184**

BOOT DRYER G184

BOOT TRAY G184

DRYER G184

ICE CLAW G184

MENS WORK INSOLE G184

SILICONE WATERPROOFER

G184

WORK INSOLE G184

**BOOTS**

SLUSH G184

**BOOT SCRUBBER G184****BOOT TRAY G184****BRACES**

CORNER G94

MENDING G92

**BRACKET**

HAND RAIL G60

**BRACKETS**

PLANT G153

SOLID BRASS G49

**BRASS PADLOCKS G43**

COMBINATION G45

**BUMPERS**

SCREW ON G55

SELF ADHESIVE G55

TACK G55

**BUTT HINGE G56****BY-PASS DOOR**

HARDWARE G28

## C

**CABINET KNOBS**

ANTIQUE FINISH G70

BRASS FINISH G69

BRASS TOPS G52

CHROME FINISH G72

NICKEL FINISH G71

OIL RUBBED BRONZE G71

PEWTER FINISH G71

PORCELAIN G70

RESIN G72

STEEL G71

WOODEN G70

**CABINET PULLS**

ANTIQUE FINISH G74

BRASS FINISH G73

CHROME FINISH G76

NICKEL FINISH G74

OIL RUBBED BRONZE G75

PEWTER G75

PLASTIC G75

STEEL G75

WOODEN G75

**CABLE**

AIRCRAFT G166

FERRULE G165

**CABLE LOCKS G46****CABLES G38****CAM LOCK G18****CAMO**

ROPE G174

**CANE BOLT G36****CARBON MONOXIDE**

DETECTORS G111

**CARPET**

CLAMP DOWN G147

**CASTER G131, G132, G133**

CUP G131

**CATCH**

BULLET G50

CABINET G79

DECORATIVE G50

DRAW G53

SCREEN DOOR G98

SOLID BRASS G52

**CEILING**

PULLEY G114

**CHAIN**

BINDER G155

COLD SHUT G160

DOOR GUARD G50

HIGH TEST G156

HOBBY G159

INCO G158

LOCK LINK G157

MACHINE G157, G158

PASSING LINK G158

PLASTIC G157

PROOF COIL G156

REPAIR LINK G160

SAFETY G157

SASH G157

SINGLE JACK G157

STRAIGHT LINK G158

TWIST LINK G158

UTILITY G158

**CHAIN BOLT G51****CHAIN GUARD G51****CHAIN LOCKS G46****CHAIN REPAIR LINK G160****CHAINS**

PLANT G152

**CHAIR**

GLIDES G131

TIPS G130

**CHEST HANDLE G97****CHILD SAFETY LOCK G51****CLAMP**

ROPE G171

**CLEATS**

ROPE G171

**CLEVIS G162**

DOUBLE LINK G163

**CLIPS**

PANEL, ALUMINUM G107

ROPE G165

SCREEN G107

**CLOSED BAR HOLDER G34****CLOSERS**

DOOR, COMMERCIAL G103

DOOR, RESIDENTIAL G103

DOOR, STORM G102

**CLOSET**

POLE SOCKET G117

ROD G117

**COIL**

CABLE RETRACTING G46

**COIN PURSE G21****COLD SHUT**

CHAIN G160

**COMBINATION PADLOCKS G45****COMMERCIAL LOCKS G12****CONCEALED HINGE G78****CONTRACTOR LOCKS G12****CORD G174**

SASH G175

**CORNER**

BRASS PLATED G50

SOLID BRASS G50

**CORNER BRACE G93****CORNER BRACES G94****CORNER HINGE G87**



## BUILDERS HARDWARE INDEX

**CORNER IRON G93**  
**CORNER KEYS G105**  
**COVERALL G135, G136**  
**COVERED PADLOCKS G43**  
**CRUTCH TIPS G130**  
**CUPBOARD CATCH G79**  
**CYLINDER REPLACEMENT G17**

**D**

**DEADBOLT**  
& CHAIN GUARD G51  
ELECTRONIC G10  
**DEADBOLTS**  
GRADE 3 G14  
SCHLAGE G10  
ULTRA G14  
WEISER G8  
**DETECTORS**  
CARBON MONOXIDE G111  
FIRE G111  
SMOKE G111  
**DISPLAY BIN G154**  
**DOOR**  
ADAPTER KIT G27  
CHAIN GUARD G51  
FINGER PULL G27  
FLIP GUARDS G95  
FLIP LOCKS G51  
HANGER G28  
KEYED CHAIN LOCK G51  
KICK PLATE G27  
KNOB PROTECTORS G63  
PLASTIC KITS G137  
SECURITY GUARD G51  
SELECT-A-LINK CHAIN FAS-  
TENER G51  
SWEEP G142  
VIEWER G27  
WEATHERSTRIP G143  
**DOOR CLOSERS**  
COMMERCIAL G103  
RESIDENTIAL G103  
STORM/SCREEN G102  
**DOOR FLIP LOCKS G51**  
**DOOR HANGER**  
SLIDING G28  
**DOOR HARDWARE**  
BY-PASS G28  
**DOOR HINGE G86**  
SCREEN G98  
**DOOR KICK PLATE G27**  
**DOOR KNOB**  
PROTECTORS G63  
**DOOR PULL G100**  
HEAVY DUTY G31  
ORNAMENTAL G31  
UTILITY G31  
**DOOR SRRING G100**  
**DOOR STOP G34**  
FLOOR G61, G63  
HINGE PIN G61  
"SOFSTOP" G63  
FLOOR G63

KICKDOWN G64  
REPLACEMENT TIP G64  
RIGID G64, G65  
RUBBER WEDGE G64  
SOFT JAMB G65  
SPRING G61, G62  
TIPS G62, G65  
WALL G63

**DOWELS G149****DOWNSPOUTS**

FITTINGS G151  
GUTTER G151  
VINYL G151

**DRAIN PIPE G151**

FLEX-DRAIN G151

**DRAW CATCH G53**

DECORATIVE G53  
LOCKABLE G53

**DRAWER LOCK G18****DRAWER SLIDE G80****DRIP EDGE G151****DRIVEWAY**

MARKERS G129

**E****ELECTRICAL OUTLET INSULA-  
TORS G146****ELECTRONIC KEY HEAD G26****EMBLEMS**

SLOW MOVING VEHICLE G129

**EURO HINGE G78****EXTENSION SPRING G40****EXTINGUISHERS**

FIRE G112

**F****FASTENERS**

SCREEN FRAME G107

**FEET WARMERS G178****FELT ADHESIVE PADS G54****FERRULE**

CABLE G165

**FIBERGLASS**

SCREEN G109

**FINGER PULL G27****FIRE DETECTORS G111****FIRE EXTINGUISHERS G112****FITTINGS**

DOWNSPOUTS G151  
GUTTER G150

**FIXED EYE**

PULLEY G113

**FLAG POLE G127****FLAGS**

FIXED BRACKET G127  
USA G127

**FLASHING**

ALUMINUM ROLL G148

**FLEX-DRAIN G151****FLEX-O-GLAZE G108****FLOOR**

DOOR STOPS G61

**FLOOR DOOR STOP G61****FOLDING DOOR**

CARPET RISER G30  
KNOB G30

**FOLDING SUPPORTS G53****FOOT BOLT G97****FULL TURN BUTTON G99****G****GALVANIZED SHEETS G148****GARAGE DOOR**

BOTTOM G146  
BOTTOM FIXTURE G38  
CABLE G40  
CABLES G38  
HANDLE G39  
HINGE G38  
PART REFERENCE G37  
PULLEY G40  
ROLLER G38, G39  
SLIDE LOCK G39  
T-LOCK HANDLE G39

**GARMENT HOOKS G68****GATE**

ANTI-SAG KIT G36

**GATE HINGE G35****GATE LATCH G35****GATE SPRING G100****GLASS**

ACRYLIC G108

**GLASS SPLINE G104****GLOVES**

ALL SEASON G182  
CANVAS G179  
COATED G180  
COLD WEATHER G181  
DRIVERS G181  
JERSEY G179  
KNIT G183  
LEATHER G181  
NITRILE COATED G180  
NYLON G180  
WINTER G182  
WORK G182

**GRAB HOOKS**

EYE G162

**GRILLS**

STORM DOOR G101

**GRIPS**

ROPE G166  
WIRE ROPE G166

**GUARD**

DOOR FLIP G95

**GUN LOCK G47****GUTTER**

DOWNSPOUT FITTINGS G151  
DOWNSPOUTS G151  
DRIP EDGE G151  
FITTINGS G150  
VINYL G150



## BUILDERS HARDWARE INDEX

**H****HANDLE**CHEST G97  
PLASTIC G52**HANDLES**

CHEST G49

**HANDLESET**

WEISER G8

**HAND WARMERS G178****HARDWARE**

SLIDING DOOR G29

**HASP**HINGE G91  
SAFETY G89, G90  
SECURITY G90  
SOLID BRASS G50**HASPLOCKS G47****HASPS G47**

SOLID BRASS G50

**HINGE**AUTOMATIC DOOR CLOSING  
G86  
BALL TIP G57  
BRASS PLATED G49  
BROAD BUTT G56  
BROAD REMOVABLE PIN G88  
CABINET G77, G78  
CAFE DOOR G86  
CONCEALED G78  
CONTINUOUS G81  
DESK BUTT G56  
EURO G78  
FULL SURFACE G88  
GARAGE DOOR G38  
GATE G35  
MIDDLE BUTT G56  
NARROW G78, G84, G85  
NARROW BUTT G56  
ORNAMENTAL TEE G36  
REMOVABLE PIN G88  
ROUND CORNER G87  
SCREEN DOOR G98  
SELF-CLOSING G77, G78  
SOLID BRASS G49  
SPRING G86, G98  
SQUARE CORNER G87  
STRAP G83  
TEE G82**HINGE PIN**DOOR STOPS G61  
FLUSH G86**HITCH**PIN G163  
PIN CLIP G164**HOOK**

ROBE G68

**HOOK AND STAPLES G52****HOOKS**COAT & HAT G66, G67, G68  
COAT, UNDERSHELF G68  
DOUBLE G66  
GARMENT G68  
GRAB, EYE G162PEGBOARD G154  
PLANT G152  
PLANT, SWAG G152  
SINGLE ROBE/CLOTHES G68  
SLIP, EYE G162  
STORAGE G153  
WARDROBE G66**I****ICE CLAW G184****INSULATORS**

SWITCH G146

**J****JAMB LATCH G34****JOIST MOUNT**

PULLEY G114

**K****KEY**

SKELETON BIT G18

**KEY BLADE G26****KEY BLANK**REFERENCE LIST  
G23, G24, G25**KEY BLANKS**BULK G22  
COLLEGIATE G22  
TEAMS G22  
USA G22**KEY CAPS G20****KEY CHAINS G21****KEY CLIPS G21****KEY HOLDERS G21****KEY IDENTIFIERS**

COLOR G20

**KEY ID TAGS G20****KEY LIGHT G20****KEYMACHINE**

BRUSH G19

**KEY REELS G21****KEY RING G20**BOLT SNAPS G20  
COILED G21  
COLOR KEY IDENTIFIERS G20  
FLOATABLE G21  
ID TAGS G20  
KEY CAPS G20  
KEY LIGHT G20  
LEATHER STRAPS G21  
SPLIT G19, G20**KEYS**CORNER G105  
TILT G106**KNIFE LATCHES G107****KNIT GLOVES G183****KNOB**CABINET  
G52, G69, G70, G71, G72  
DECORATIVE G52  
ULTRA  
BRASS REPLACEMENT G18

GLASS REPLACEMENT G18

**KNOBS**

WEISER G8

**L****LAMINATED PADLOCKS G41****LANYARDS G21****LATCH**CABINET G79  
GATE G35  
JAMB G34**LATCHES**BAIL G107  
KNIFE G107  
PLUNGER G107  
STORM DOOR G101**LETTER STENCIL G123****LEVERS**

WEISER G8

**LID SUPPORT G53, G54****LINK**

CHAIN G160

**LINOLEUM BINDING G141****LOCK**BIT KEY MORTISE G16  
CAM G18  
CHILD SAFETY G51  
DEADLOCKING  
CYLINDER REPLACEMENT G17  
DEADLOCKING NIGHT LATCH  
G17  
DRAWER G18  
NIGHT LATCH G17  
POCKET DOOR PRIVACY G15  
RE-KEYING CYLINDER G15  
SHOWCASE G47  
SLIDING DOOR PASSAGE G15  
SLIDING DOOR PRIVACY G15  
UTILITY G18**LOCKS**BACK PACK G47  
CABLE G46  
CHAIN G46  
CONTRACTOR/COMMERCIAL  
G12  
GUN G47  
STORM DOOR G101**LOCKSETS**GRADE 3 G14  
SCHLAGE G6  
ULTRA G13, G14**LUGGAGE ID G21****LUGGAGE LOCK G45****M****MAGNETIC LATCH G79****MAILBOX G118****MARKER**MOUNT PLASTIC SPIKES G129  
SAFETY, DRIVEWAY G129**MARKERS**

DRIVEWAY G129



## BUILDERS HARDWARE INDEX

**MENDING BRACES G92**  
**MENDING PLATES G92**  
**MORTISE LOCK G16****MOULDING**FIBER G139  
FLEX-O-CHANNEL G139  
WOOD G139**N****NIGHT LATCH G17**DEADBOLT G17  
JIMMYPROOF G17**NUMBERS**HOUSE, COLONIAL G124  
& LETTERS, BOAT G120  
& LETTERS, REFLECTIVE G121  
& LETTERS, STENCIL G123  
& LETTERS PACKAGED G119  
3-D G123  
PACKAGED G119  
SOLID BRASS G124**NUMBER STENCIL G123****NYLON ROLLERS G39****O****OPEN BAR HOLDER G34****P****PADLOCK**

MINATURE G52

**PADLOCKS**ALUMINUM G44  
ARMORED G42  
BRASS G43  
COMBINATION G45  
COMBINATION, BRASS G45  
COVERED G43  
LAMINATED G41  
LUGGAGE LOCK G45  
RUSTOLEUM LAMINATED G43  
SHROUDED G42  
STEEL G44  
TITANIUM G44  
TSA G44  
UNIVERSAL G41  
WARDED G42**PANEL CLIPS**

ALUMINUM G107

**PEGBOARD**

HOOKS G154

**PET SCREEN G110****PIN**HINGE, FLUSH G86  
HITCH G163  
HITCH PIN CLIP G164**PIPE**

DRAIN G151

**PLANT**BRACKETS G153  
CHAINS G152  
HOOKS G152  
SWAG HOOKS G152**PLASTIC SIGNS G126****PLATE**

HANGER G52

**PLATES**MENDING G92  
T G92**PLATE STAPLES G91****PLUNGER LATCHES G107****POCKET DOOR**BUMPER & GUIDE G27  
FRAME G27  
HARDWARE SET G27**POCKET WARMERS G178****POLY COVER G135****POWER PULL G164****PULL, CABINET****G73, G74, G75, G76****PULL, DOOR**FLUSH RING G52  
HEAVY DUTY G31  
ORNAEMNTAL G31  
UTILITY G31**PULLEY G40**AWNING G113, G114  
FIXED EYE G113  
JOIST MOUNT G114  
SCISSORS HOOK G114  
SWIVEL EYE G113  
SWIVEL HOOK G114  
WALL/CEILING G114**PULL HANDLES G39****Q****QUICK SNAP G169****R****RAINSUIT G184****REFLECTORS**

BRACKETED G129

**RE-KEYING G15****REPLACEMENT KNOB**BRASS G18  
GLASS G18**RESIDENTIAL LOCKSETS G6****RIGID HANGER G32****RING**

DOOR TRAP G97

**RING PULL G52****ROD**

SUPPORT, CLOSET G115

**ROLLER G34****ROLLER BRACKET G38****ROLLER CATCH G79****ROLLERS G39****ROPE**BRAID NYLON G172  
CAMO G174  
CLAMP G171  
CLEATS G171  
CORD, TWINE G174  
GRIPS G166  
MANILA G173  
POLYPROPYLENE G173

SISAL G173

THIMBLE G166

TWISTED NYLON G172

UNMANILA G172

**ROPE CLIPS G165****S****SAFETY CABLES G38****SASH**LIFT G58  
LOCK G59**SCISSORS HOOK**

PULLEY G114

**SCREEN**ALUMINUM G109  
CLIPS, PLASTIC G107  
FIBERGLASS G109  
FRAME FASTENERS G107  
HANGER G99  
MOUSE G104  
PET G110**SCREEN DOOR**CATCH G98  
HINGE G98  
SET G98  
TURNBUCKLES G100**SCREEN MOUSE G104****SCREEN SPLINE G104****SCREW HOOK G36**

&amp; STRAP HINGE G36

**SCRUBBER**

BOOT G184

**SHACKLE**

ANCHOR G162

**SHELF**BRACKET G115  
BRACKET SCREWS G115  
LINER, PLAST-O-MAT G134  
SUPPORT G116**SHIMS**

PINEWOOD G149

**SHOWCASE LOCK G47****SHROUDED PADLOCKS G42****SIGN**ADDRESS PLATE G126  
ALUMINUM G125, G126  
LAWN G125, G126  
PLASTIC G125, G126, G128  
POSTED, ROLL G125  
TRAFFIC G126**SKELETON BIT KEY G18****SLIDE BOLT G51****SLIDE LOCK**

INTERIOR G39

**SLIDING DOOR**CARPET RISER G28  
GUIDE G28  
HARDWARE G29  
RIGID HANGER G32  
TROLLEY RAIL G32, G33**SLIP HOOKS**

EYE G162



**BUILDERS HARDWARE INDEX**

**SLOW MOVING VEHICLE**

EMBLEM G129

**SLUSH**

BOOTS G184

**SMOKE DETECTORS G111**

**SNAPS**

BIT G170

BOLT G168

BREECHING G170

CHAIN G170

HOOKS G170

QUICK G169

ROPE G170

SPRING G167, G169

TRIGGER G169

**SPIKES**

MARKER MOUNTS G129

**SPLINE**

GLASS G104

PULL TABS G107

SCREEN G104

**SPLIT KEY RING G19, G20**

**SPRING**

SNAP G167

**SPRING HINGE G86, G98**

**STAIR NOSING G147**

**STAPLE**

WIRE G91

**STAY ROLLER G34**

**STEEL PADLOCKS G44**

**STEEL ROLLERS G39**

**STENCIL**

NUMBER & LETTER G123

**STORAGE**

HOOKS G153

**STORM DOOR**

CHAIN STOP G102

CLIPS G102

CLOSERS G102

GRILLS G101

LATCHES G101

LOCK G101

STRIKE PLATE G101

WINDOW CONTROL G102

**STRIKE**

MORTISE LOCK G18

STORM DOOR G101

**STRIKES G11**

**STRIKES & LATCHES G11**

**SUPPORTS**

LID G53

**SWAGING**

TOOL G165

**SWITCH INSULATORS G146**

**SWIVEL EYE**

PULLEY G113

**SWIVEL HOOK**

PULLEY G114

**T**

**TABLE**

LEG BRACE G117

**TAPE**

DOUBLE FACE G138

TRANSPARENT G137

**TARP**

POLY G134

**THIMBLE**

ROPE G166

**THRESHOLD G141**

**TILT KEYS G106**

**TIP HINGES G57**

**TIPS**

CRUTCH G130

**TITANIUM PADLOCK G44**

**T-LOCK HANDLE G39**

**TOE WARMERS G178**

**T PLATES G92**

**TRAFFIC**

SIGNS G126, G129

**TRANSPONDER KEY G26**

**TRAP DOOR RING G97**

**TROLLEY RAIL G32**

BRACKET G33

SPLICE BRACKET G33

**TSA PADLOCKS G44**

**TUBES**

"TAKE ONE" G129

**TWINE G174, G175**

**U**

**UNIVERSAL PADLOCKS G41**

**USA FLAG SET G127**

**UTILITY LOCK G18**

**V**

**VINYL**

GUTTER FITTINGS G150

**VINYL GUTTERS G150**

**W**

**WALL**

PULLEY G114

**WARDED PADLOCKS G42**

**WARMERS**

HAND G178

POCKET G178

TOE G178

**WEATHERSTRIP G143**

FELT G145

FOAM G144

NAILS G143

ROPE CAULK G145

**WINCH PULLER G164**

**WINDOW**

BOLT G99

MATERIAL

FLEX-O-GLASS G140

FLEX-O-PANE G140

PIN G99

PLASTIC KITS G137

SHRINK IT PLASTIC G138

**WIRE**

ANNEALED G176, G177

GALVANIZED G177

MACHINE G177

PLANT G176

SMALL DIAMETER G176

TRANSPARENT G176

**WIRE ROPE**

GRIPS G166

**WIRE STAPLE G91**

**WORK INSOLE G184**



**Residential Locksets - Knobs and Levers Styles**

**KNOB/LEVER DESIGN OPTIONS — F SERIES**

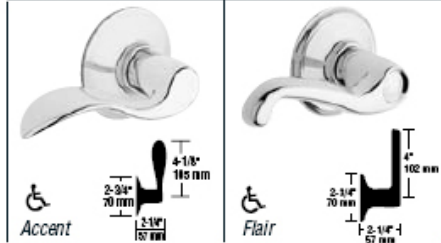
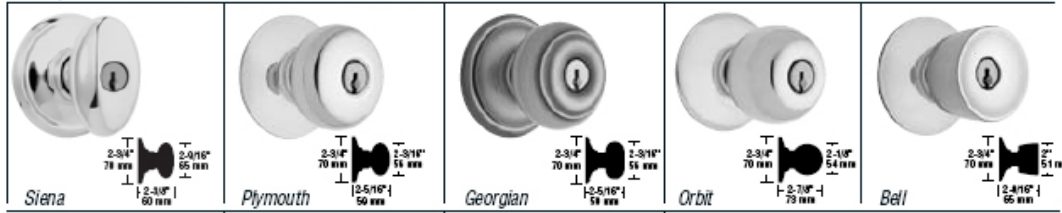

Styles found on Pages G-7 to G-9

Item	Pack	Part #	HDI #
<b>Georgian Visual Pack</b>			
<i>Platinum Nickel</i>			
Keyed Entry KA4	4	F51VGEO-619	428723

**RESIDENTIAL LOCKSETS - KNOBS**

**SCHLAGE**

Item	Pack	Part #	HDI #
F Series. Universal latch fits 2 3/8" or 2 3/4" backsets. Triple option latch fits square corner, radius corner, or drive-in applications. Full lip strike 10-026 meets ANSI Grade 2 requirements.			
<b>Plymouth Visual Pack</b>			
<i>Bright Brass</i>			
Hall/Closet	4	F10VPLY-605	428558
Bed/Bath	4	F40VPLY-605	428559
<b>Bell Style Visual Pack</b>			
<i>Bright Brass</i>			
Hall/Closet	4	F10VBEL-605	428600
Bed/Bath	4	F40VBEL-605	428605



BUILDERS HARDWARE

**RESIDENTIAL LOCKSETS - LEVERS**

Item	Pack	Part #	HDI #
Universal latch fits 2 3/8" or 2 3/4" backset. Triple option latch fits square corner, radius corner, or drive-in applications. Full lip strike. <b>For Left or Right Hand</b>			
<b>Accent Style</b>			
<i>Satin Nickel - Visual Pack</i>			
Hall/Closet	4	F10VACC-619	428708
Bed/Bath	4	F40VACC-619	428710
Keyed Entry KA4	4	F51VACC-619	428712



BUILDERS HARDWARE

Residential Locksets



WELCOME HOME KNOBS & LEVERS  
KW-1 Keyway



ELEMENTS KNOBS & DEADBOLTS  
KW-1 Keyway

Item	Pack	Part #	HDI #
Universal latch fits 2 3/8" to 2 3/4" backset. 4-way adjustable latch. Includes strike for square corner. Reversible for right or left hand doors.			
<b>Beverly</b>			
<i>Polished Brass</i>			
Keyed Entry K3	6	GAC 531	429032
Privacy	6	GAC 331	429031
Passage	6	GAC 101	429030
Deadbolt K3	6	GDC9471	429029

Item	Pack	Part #	HDI #
Adjustable 2 3/8" or 2 3/4" backset. 4-way adjustable latch. Includes strikes for square corner. <b>SmartKey Entry Knobs.</b> Reversible for right or left hand doors unless noted. <b>Grade 2</b>			
<b>Troy Knobs</b>			
<i>Polished Brass</i>			
Entry SmartKey K4 Lifetime Finish	4	GA 531	429100
Privacy	4	GA 331	429101
Passage	4	GA 101	429102
Dummy	4	GA 12	429103
<i>Satin Nickel</i>			
Entry SmartKey K4	4	GA 531	429104
Privacy	4	GA 331	429105
Passage	4	GA 101	429106
Dummy	4	GA 12	429107
<i>Venetian Bronze</i>			
Entry SmartKey K4	4	GA 531	429108
Privacy	4	GA 331	429109
Passage	4	GA 101	429110
Dummy	4	GA 12	429111
<b>Toluca Levers</b>			
<i>Polished Brass</i>			
Entry SmartKey K4 Lifetime Finish	4	GLA 535	429112
Privacy	4	GLA 331	429113
Passage	4	GLA 101	429114
Dummy Right Hand	4	GLA 12	429115
Dummy Left Hand	4	GLA 12	429116
<i>Satin Nickel</i>			
Entry SmartKey K4	4	GLA 535	429117
Privacy	4	GLA 331	429118
Passage	4	GLA 101	429119
Dummy Right Hand	4	GLA 12	429120
Dummy Left Hand	4	GLA 12	429121
<i>Venetian Bronze</i>			
Entry SmartKey K4	4	GLA 535	429122
Privacy	4	GLA 331	429123
Passage	4	GLA 101	429124
Dummy Right Hand	4	GLA 12	429125
Dummy Left Hand	4	GLA 12	429126

WELCOME HOME DEADBOLTS  
KW-1 Keyway



Item	Pack	Part #	HDI #
Adjustable 2 3/8" to 2 3/4" backset. <b>SmartKey.</b> Single Cylinder. <b>Grade 1</b>			
Lifetime Polished Brass	4	GD9471 X 3BR	429127
Satin Nickel	4	GD9471 X 15	429128
Venetian Bronze	4	GD9471 X 11P	429129

WELCOME HOME HANDLESET  
KW-1 Keyway



Item	Pack	Part #	HDI #
Deadbolt and handle adjustable 2 3/8" to 2 3/4" backset. Round corner adjustable latch. Includes strike for round corner. <b>SmartKey Deadbolt - Grade 1</b>			
<b>Augusta Style - Lifetime Polished Brass Exterior</b>			
Troy Knob Interior Lifetime Polished Brass	2	GA9471 A/T3BR	429130
Troy Knob Interior Satin Nickel	2	GA9471 A/T15	429135
Toluca Lever Interior Satin Nickel	2	GLA9471 A/TC15	429131
Toluca Lever Interior Venetian Bronze	2	GLA9471 A/TC11P	429132





**HARDWARE DISTRIBUTORS, INC.**

**BUILDERS HARDWARE**

Page: G9  
Date: 06/06/12

---



BUILDERS HARDWARE



B60N



BR262V



GED1490

RESIDENTIAL DEADBOLTS

SCHLAGE

Item	Pack	Part #	HDI #
1" throw. Adjustable 2 3/8" or 2 3/4" backset. Triple option latch fits square corner, radius corner, or drive-in applications. Door frame reinforcer. Thrown or retracted by key from outside or by inside turn unit.			
<b>Heavy Duty Single Cylinder - Visual Pack KA4</b>			
Satin Nickel	4	B60NV-619	428682
Antique Pewter	4	B60NV-620	428683

WEISER

Item	Pack	Part #	HDI #
<b>SmartCode Electronic Deadbolt</b> - With your own personal code, you can enter your home with just a few simple pushes of a button and lock it with just one. You also get more control over who has access to your home. Just assign a temporary code to whoever needs one and delete it when you see fit. Now you can totally eliminate the need for keys. SmartCode is easy to install, program and use and operates on 4 AA batteries. SmartCode complements any Weiser knob, lever or handleset.			
Satin Nickel Finish	2	GED1490-15	429134
Polished Brass Finish	2	GED1490-3BR	429133
Venetian Bronze	2	GED1490-11P	429136



83371-001

LATCHES

WEISER

Item	Pack	Part #	HDI #
<b>Adjustable SCAL Deadbolt Latch</b>			
	6	820310-003	429075
<b>Drive-In Latch D-I 26506 DB R FAL</b>			
	10	83371-001	429070
<b>Adjustable Dead Latch</b> - Can be used with all Weiser knobs and levers.			
Square Corner - Brass	1	820079	429014
Drive In - Brass	1	820080	429016



BUILDERS HARDWARE

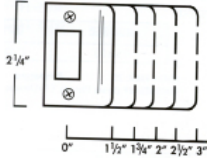

Extended Lip



Square Corner



Deadbolt

STRIKES

DON-JO

Item	Pack	Part #	HDI #
<b>Extended Lip - 2 1/4" Square Corner</b>			
<b>Brass</b>			
1 1/2"	10	9115-605	427049
1 3/4"	10	9175-605	427053
2" Round Corner	10	9102-605-RC	427061
2"	10	9102-605	427042
3"	10	9103-605	427047
<b>Stainless Steel</b>			
1 1/2"	10	9115-630	427043
1 3/4"	10	9175-630	427054
2"	10	9102-630	427046
2 1/2"	10	9125-630	427052
3"	10	9103-630	427048
<b>Duro Coated (Oil Rubbed Bronze)</b>			
1 1/2"	10	9115-DU	427112
1 3/4"	10	9175-DU	427113
2"	10	9102-DU	427114
2 1/2"	10	9125-DU	427115
<b>Standard Strike - Replacement - 2 1/4" x 1 1/4"</b>			
<b>Satin Nickel</b>			
Square Corner	10	ST-214-619	427086
Round Corner	10	ST-214RC-619	427087
<b>Brass</b>			
Square Corner	10	ST-214-605	427088
Round Corner	10	ST-214RC-605	427089
<b>Deadbolt Strikes - Replacement - 2 3/4" x 1 1/8"</b>			
Brass	10	DS-234-605	427081
Stainless Steel	10	DS-234-630	427082

STRIKES

WEISER

<b>Strike Deadbolt</b> - Square corner/full lip will fit schlage. Bulk. <b>Bright Brass</b>			
Security Strike	10	10046-BX-3	429080



BUILDERS HARDWARE

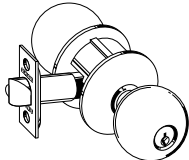

F51CSV

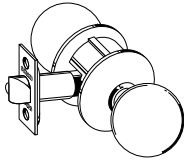

F10CSV

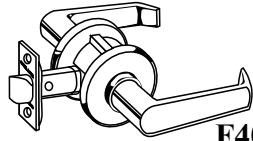

F40CSV

CONTRACTOR / COMMERCIAL LOCKS

SCHLAGE

Item	Pack	Part #	HDI #
<b>Contractor Series - Orbit Style. Entrance lock. Unlocked by key from outside, turn-button lock inside. Inside knob always unlocked. KA4</b>			
Bright Brass	4	F51CSV-605	428305
<b>Contractor Series - Orbit Style. Satin Chrome</b>			
Passage	4	F10CSV-626	428312
Bath/Bed Privacy	4	F40CSV-626	428313



44269



44294



02047



43740



43755

CONTRACTOR / COMMERCIAL LOCKS

ULTRA HARDWARE

Item	Pack	Part #	HDI #
<b>Commercial Grade 2 - Solid Brass. Fits doors from 1 3/8" to 1 3/4" thick. 2 3/4" backset UL listed latch bolt. Cold rolled steel housing. Reversible, non-handed. Stainless Steel</b>			
Lever Style SC-1 Keyway			
Keyed Entry Lock	6	44269	420577
Passage	6	44271	420580
Privacy	6	44270	420585
Ball Style SC-4 Keyway			
Keyed Entry Lock	6	44236	420586
Passage	6	44296	420587
Privacy	6	44295	420588
<b>Contractor Series Storeroom Lock - Outside knob fixed. Entrance by key only. Inside knob always unlocked.</b>			
Ball Style - KA Stainless steel SC-4 Key way	6	44134	428310
<b>Panic Exit Device - UL listed. Adjustable 25-36" doors. Non-handed. Fits doors up to 36" x 90". Minimum door size is 25"</b>			
Aluminum Finish	6	02047	440210
<b>Commercial Deadbolt Grade 2 - Heavy duty solid brass. Adjustable latch. SC-4 Keyway. Stainless Steel Finish</b>			
Single Cylinder	6	43740	420590
Double Cylinder	6	43755	420591



BUILDERS HARDWARE

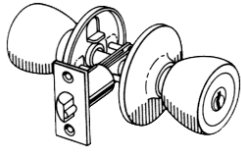

Promo Series

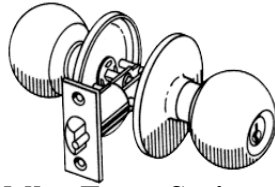

Valley Forge Series

GRADE 3 LOCKSET

ULTRA HARDWARE

Item	Pack	Part #	HDI #
<b>Promo Series - Tulip Knob, Solid Brass, Adjustable Latch, KW-1 Key</b>			
<i>Polished Brass</i>			
Keyed Entry KA3	6	43952	420510
Passage (Hall/Closet)	6	43962	420500
Privacy (Bed/Bath)	6	43964	420505
Combo Set (Entry & Deadbolt)	6	43969	420520
<i>Stainless Steel</i>			
Keyed Entry KA3	6	43974	420511
Passage (Hall/Closet)	6	43976	420513
Privacy (Bed/Bath)	6	43977	420512
Combo Set (Entry & Deadbolt)	6	43971	420521
<i>Antique Brass</i>			
Keyed Entry KA3	6	43944	420526
Passage (Hall/Closet)	6	43961	420528
Privacy (Bed/Bath)	6	93959	420527
<b>Valley Forge Series - Ball Knob, Solid Brass, Adjustable Latch, KW-1 Key</b>			
<i>Polished Brass</i>			
Keyed Entry KA3	6	43471	420525
Passage (Hall/Closet)	6	43473	420530
Privacy (Bed/Bath)	6	43472	420535
<i>Satin Nickle Finish (US-15)</i>			
Keyed Entry KA3	6	43895	420540
Passage (Hall/Closet)	6	43896	420545
Privacy (Bed/Bath)	6	43897	420550
Dummy 2 Pack	6	43898	420553
Combo Set (Entry & Deadbolt)	3	43451	393015



Lexington Series

GRADE 3 LOCKSET

ULTRA HARDWARE

Item	Pack	Part #	HDI #
<b>Lexington Series - Lever Accent Style, Solid Brass, Adjustable Latch, SC-1 Key</b>			
<i>Polished Brass US-3</i>			
Keyed Entry KA3	6	95714	420605
Passage (Hall/Closet)	6	44350	420610
Privacy (Bed/Bath)	6	44340	420615
<i>Satin Nickle US-15</i>			
Keyed Entry KA3	6	95715	420625
Passage (Hall/Closet)	6	44351	420630
Privacy (Bed/Bath)	6	44341	420635
Dummy 2 Pack	6	44321	420640
<i>Oil Rubbed Bronze US-10B</i>			
Keyed Entry KA-3	6	95716	420645
Passage (Hall/Closet)	6	44352	420650
Privacy (Bed/Bath)	6	44342	420655
Dummy 2 pack	6	44322	420656



BUILDERS HARDWARE

**GRADE 3 LOCKSETS**



ULTRA HARDWARE

Item	Pack	Part #	HDI #
<b>Sturbridge Series</b> - Plymouth Style, Brass, Adjustable Latch			
<i>Polished Brass US-3</i>			
SC-1 Keyed Entry KA3	6	43056	393009
KW-1 Keyed Entry KA3	1	43046	393019
Passage (Hall/Closet)	6	43058	393012
Privacy (Bed/Bath)	6	43057	393010
SC-1 Combo Set (Entry & Deadbolt)	3	43047	393007
<i>Satin Nickel US-15</i>			
SC-1 Keyed Entry KA3	6	42033	393001
KW-1 Keyed Entry KA3	1	42028	393011
Passage (Hall/Closet)	6	42039	393003
Privacy (Bed/Bath)	6	42038	393002
Dummy 2 Pack	6	42041	393004
SC-1 Combo Set (Entry & Deadbolt)	3	42043	393005
<i>Oil Rubbed Bronze US-10B</i>			
SC-1 Keyed Entry KA3	6	43433	393031
KW-1 Keyed Entry KA3	1	42045	393037
Passage (Hall/Closet)	6	43435	393033
Privacy (Bed/Bath)	6	43434	393032
SC-1 Combo Set (Entry & Deadbolt)	3	42049	393036



**GRADE 3 DEADBOLTS**

ULTRA HARDWARE

Item	Pack	Part #	HDI #
Brass, Adjustable Latch, KA3			
<b>KW-1 Keyway</b>			
<i>Polished Brass US-3</i>			
Single Cylinder			
Promotional	6	43967	420515
Better	6	43605	393016
Double Cylinder			
<i>Stainless Steel SS</i>			
Single Cylinder			
Promotional	6	43978	420516
<i>Antique Brass US-5</i>			
Single Cylinder			
Promotional	6	43970	420529
<i>Satin Nickel US-15</i>			
Single Cylinder			
Double Cylinder			
Oil Rubbed Bronze US-10B			
Single Cylinder			
6			
42067			
393038			
<b>SC-1 Keyway</b>			
<i>Polished Brass US-3</i>			
Single Cylinder			
6			
42057			
393000			
Double Cylinder			
6			
42058			
393020			
<i>Satin Nickel US-15</i>			
Single Cylinder			
6			
42055			
393018			
<i>Oil Rubbed Bronze US-10B</i>			
Single Cylinder			
6			
43436			
393035			



**RE-KEYING**

Locks can be re-keyed to match new or existing locks. (systems).

Cost per cylinder

(900101) \_\_\_\_\_  
pk 1



**POCKET DOOR LOCK -  
PRIVACY  
LE JOHNSON**

For 1-3/8" doors only. Fits standard 2-1/8 bore with 2-3/8 backset. Non-handed. Latches automatically. Safety release.

Bright Brass  
(466090) \_\_\_\_\_ 1521-3  
pk 5

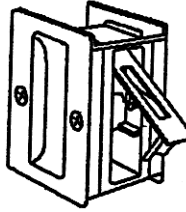

**SLIDING DOOR LOCK -  
PASSAGE**

**DON-JO**  
1-3/8" doors.  
Recessed pulls on both sides and flush pull on edge of door.

Bright Brass 990B-3  
(428390) \_\_\_\_\_ PDL-100-605  
Satin Nickel 990B-619  
(428401) \_\_\_\_\_ PDL-100-619  
Antique Pewter 990B-620  
(428402) \_\_\_\_\_ PDL-100-620  
Antique Brass 990B-5  
(420395) \_\_\_\_\_ PDL-100-609  
Bright Chrome 990B-625  
(428403) \_\_\_\_\_ PDL-100-625  
Oil Rubbed Bronze  
(427085) \_\_\_\_\_ PDL-100-613  
Satin Chrome  
(427090) \_\_\_\_\_ PDL-100-626  
pk 10

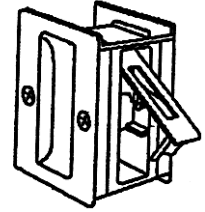

**SLIDING DOOR LOCK -  
PRIVACY**

**DON-JO**  
1-3/8" doors  
Lock and unlock by turn button inside.  
Emergency release on outside.

Bright Brass 991B-3  
(428400) \_\_\_\_\_ PDL-101-605  
Antique Brass 991B-5  
(428404) \_\_\_\_\_ PDL-101-609  
Satin Nickel 991B-619  
(428405) \_\_\_\_\_ PDL-101-619  
Antique Pewter 991B-620  
(428406) \_\_\_\_\_ PDL-101-620  
Bright Chrome 991B-625  
(428407) \_\_\_\_\_ PDL-101-625  
Oil Rubbed Bronze  
(427095) \_\_\_\_\_ PDL-101-613  
Satin Chrome  
(427100) \_\_\_\_\_ PDL-101-626  
pk 10



BUILDERS HARDWARE



**BIT KEY MORTISE LOCK**

ILCO

Universal type replacement bit key lock. Bright polished brass finish. Furnished with two keys. Deadbolt locks from both sides with key. Carded.

(450010) \_\_\_\_\_ 214-04-51  
pk 5





BUILDERS HARDWARE

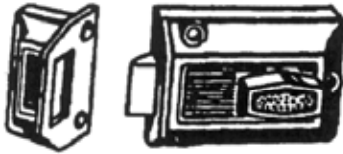

**RIM NIGHT LATCH  
ILCO**

Economical. Single cylinder. Key outside-turn knob inside. Rose gold finish.

22430  
(450020) \_\_\_\_\_ 220-53-41  
pk 5

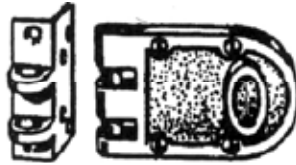

**JIMMYPROOF NIGHT  
LATCH  
ILCO**

Single cylinder. Key outside-turn knob inside. Bronze finish

22530  
(450030) \_\_\_\_\_ 530-53-51  
pk 5

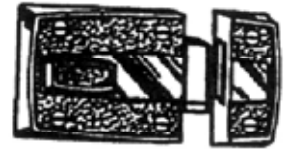

**DEADLOCKING NIGHT  
LATCH  
ILCO**

Single cylinder. Key outside-turn knob inside. Deadlocking pin.

540-54-51  
(450040) \_\_\_\_\_ 540-54-51  
pk 5

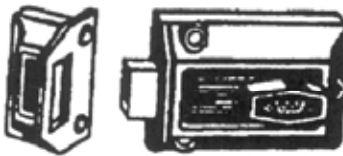

**DEADBOLT NIGHT LATCH  
ILCO**

Single cylinder. 3/4" throw. Key outside-turn knob inside.

545-5351  
(450055) \_\_\_\_\_ 545-5351  
pk 5

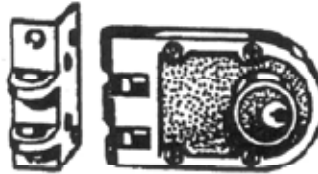

**JIMMYPROOF NIGHT  
LATCH  
ILCO**

Double cylinder. Key operated on both sides. Bronze finish

1967CS  
(450035) \_\_\_\_\_ 535-53-51  
pk 5



**CYLINDER  
REPLACEMENT  
ILCO**

Replaces all standard size cylinders for rim deadlocks. Fits doors 1" to 2" thick. 5 pin tumbler. Carded

22135  
(450060) \_\_\_\_\_ 605-04-51  
pk 10

BUILDERS HARDWARE

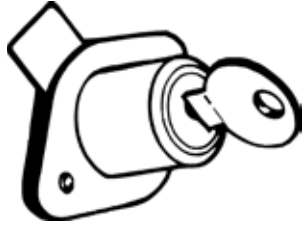

**DRAWER LOCK**  
**NATIONAL V826**

Lock for 3/4" drawers. Keyed cylinder. 3/4" hole size. Bright brass finish.

**1 per card** with screws  
(465575) \_\_\_\_\_ N183-772  
pk 5



**MORTISE LOCK STRIKE**  
**ILCO**

Replacement strike for bit key locks. Brass finish. 3 5/16 x 7/8"

(450015) \_\_\_\_\_ 733-03-11  
pk 10



**UTILITY LOCK**  
**NATIONAL V825**

For locking wood or metal cabinet doors and drawers. Zinc finish. **1 per card**

1/4" thick  
(465573) \_\_\_\_\_ N183-756  
1/2" thick  
(465574) \_\_\_\_\_ N183-764  
3/4" thick  
(465572) \_\_\_\_\_ N192-476  
pk 5



**DRAWER LOCK**

All purpose cabinet and drawer lock. 5 disc tumbler mechanism. Complete with two keys. Easy installation. Drill 7/8" hole 3/4" from edge of drawer. Brass finish.

**ILCO**  
Key alike  
(450070) \_\_\_\_\_ 4067-03-11KA  
pk 5



**BRASS REPLACEMENT**  
**KNOBS**  
**ULTRA HARDWARE**

Traditional design. Satin brass. Visual box pack. Spindle and set screw included.

(450090) \_\_\_\_\_ 22330  
43005-U  
pk 5



**SKELETON BIT KEY**  
**ILCO**

Malleable iron bit key for rim and mortise locks. Nickel plated. 5 per pkg  
*sold/price per pkg*

(445895) \_\_\_\_\_ 2/2B  
pk 5



**CAM LOCK**  
**NATIONAL - VKA825**

For a variety of uses. Includes two stop washers for 90° and 180° operation and a spur washer for mounting on wood or metal. 1 1/8" shell length. Fits doors up to 3/4" thick. Zinc finish.

Key alike 111-14-51-KA  
(450080) \_\_\_\_\_ N192-484  
pk 5



**GLASS REPLACEMENT**  
**KNOB**  
**ULTRA HARDWARE**

Crystal design. Bright brass hardware. Visual box pair. Spindle & set screw included.

(450085) \_\_\_\_\_ 05363  
43000-U  
pk 10



**SKELETON BIT KEY**  
**ILCO**

Malleable iron bit key for rim and mortise locks. Nickel plated. Notched

5 per pkg  
*sold/price per pkg*  
(445900) \_\_\_\_\_ 3/7B  
pk 5



BUILDERS HARDWARE



**SPLIT KEY RING**

ILCO

Nickel plated steel wire.  
Measurements taken from inside diameter.

3/4" - 20mm                      HAO142

(450100)                              262-00-8X

1" - 25mm                              HAO144

(450101)                              264-00-8X

pk 100

1 1/4" - 32mm                      HAO146

(450102)                              266-00-8X

1 1/2" - 38mm                      HAO147

(450103)                              267-00-8X

2" - 51mm                              HAO148

(450104)                              268-00-8X

pk 50



**BRUSH FOR KEY MACHINE**

ILCO

Nylon deburring brush. For most Ilco Unican, Taylor and Dominion machines. 3" diameter with 1/2" arbor hole.

(445005)    814

pk 1



BUILDERS HARDWARE



**SPLIT KEY RINGS**

HY-KO

Holds a number of keys securely.  
Formed, rust resistant steel.

**Carded**

1"  
(430420) \_\_\_\_\_ KC105

1 1/4"  
(430422) \_\_\_\_\_ KC107  
pk 5

**KEY RINGS**

HY-KO

Carded



Pull-apart, silver key ring  
(430432) \_\_\_\_\_ KC116



Spring Lock key ring  
(430424) \_\_\_\_\_ KC122



Nylon Coated Cable  
key ring  
(430434) \_\_\_\_\_ KC123



2-3/8" Small aluminum  
C-Clip key ring  
(430426) \_\_\_\_\_ KC125



3-1/8" Large aluminum  
C-Clip key ring  
(430428) \_\_\_\_\_ KC127  
pk 5

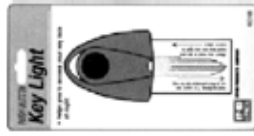

**KEY LIGHT**

HY-KO

Push button key light helps access key  
locks at night.

**Carded**

(430436) \_\_\_\_\_ KC166  
pk 5



**BOLT SNAPS**

HY-KO

Large bolt snap. Sturdy snap for belt  
loops, shoulder strap, backpacks,  
totes.

**Carded**

(430430) \_\_\_\_\_ KC176  
pk 5

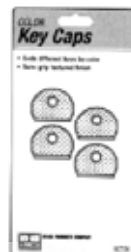

**KEY CAPS**

HY-KO

Code different keys by color. Sure grip  
textured finish.

**4 per card**  
(430410) \_\_\_\_\_ KC134  
pk 5

**KEY ID TAGS**

HY-KO



**2 per card**  
Key ID tag with swivel ring  
(430406) \_\_\_\_\_ KC139



Key ID tag with beaded  
chain  
(430404) \_\_\_\_\_ KC140

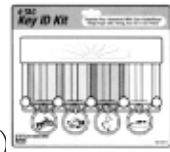

**4 per card**  
Key ID tag kit  
(easy open key tags)  
(430402) \_\_\_\_\_ KC143-4



**25 per pkg**  
1 1/4" Paper ID tag  
with split ring  
(430408) \_\_\_\_\_ KC144  
pk 5

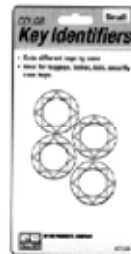

**COLOR KEY IDENTIFIERS**

HY-KO

**4 per card**  
Small key identifiers  
(430412) \_\_\_\_\_ KC129

Medium key identifiers  
(430414) \_\_\_\_\_ KC130  
pk 5

**3 per card**  
Large Neon key identifiers  
(430416) \_\_\_\_\_ KC133  
pk 5



BUILDERS HARDWARE



**COILED KEY RINGS**

**HY-KO**  
Neon coiled key ring with split ring. Keys stay safe and handy during work, exercise or play. Never loses its shape.  
**Carded**

(430418) KC151  
pk 5



**KEY CHAINS**

**HY-KO**  
Compact for pocket or purse. 6" beaded key chain.

**2 per card**  
(430446) KC192  
pk 5

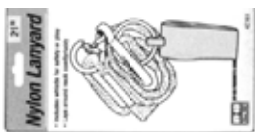

**LANYARDS**

**HY-KO**  
Nylon lanyard. Lays around neck comfortably.  
**Carded**

21" with whistle  
(430438) KC161  
pk 5



**KEY REELS**

**HY-KO**  
Ideal for industrial environments. 24" tough, retractable chain. Smooth steel cover..  
**Carded**

(430456) KC190  
pk 5



**LEATHER STRAPS**

**HY-KO**  
Snap-on genuine leather key strap with metal clip snaps on belts, totes, backpacks, briefcases.  
**Carded**

(430444) KC185  
pk 5



**LUGGAGE ID & COIN PURSE**

**HY-KO**  
**Carded**  
Leather-look Luggage ID tag can be used on luggage, briefcases, laptops and totes. Secure never fall out ID card. 2 1/4" x 3 1/2"

(430454) KC150  
pk 5

Squeeze coin holder with beaded chain, is ideal for loose change or emergency money.

(430448) KC157  
pk 5



**KEY CLIPS**

**HY-KO**  
**Carded**  
Clip-on, stainless-steel, safety key clip with split ring

(430442) KC181

Metal, belt clip with split ring  
(430440) KC182  
pk 5

**KEY HOLDERS**

**HY-KO**  
**Carded**  
Photo key-holder, key ring 2 1/4" x 3 1/4"  
(430450) KC149



Wallet key holder  
(430458) KC163



Large magnetic key holder  
(430462) KC164



Rock key hider - outdoor use  
(430464) KC165



Stick-on key wallet 4" x 2 5/8"  
(460460) KC168  
pk 5



**FLOATABLE KEY RING**

**HY-KO**  
Glo-buoy key ring with beaded chain. Watertight compartment holds cash, id, etc. inside and keeps keys afloat.

**Carded**  
(430452) KC159  
pk 5



BUILDERS HARDWARE



**KW1NP M1BR SC1NP WR5NP 800004**

**BULK KEY BLANKS**

**ILCO**

Item	Pack	Part #	HDI #
250 blanks per box. Sold/Price Per Box			
KW1	1	KW1BR	445411
M1	1	M1BR	445431
SC1	1	SC1BR	445636
WR5	1	WR5NP	445767

**WEISER**

Item	Pack	Part #	HDI #
<b>SmartKey</b> - For use in Weiser SmartKey locks.			
KW1	50	800004	429140

**SCHLAGE**

Item	Pack	Part #	HDI #
<b>Blue Key</b> - For use in Schlage locks that use the SecureKey technology.			
SC1	50	BLUE-35	428500



**COLLEGIATE KEY BLANKS**

**ILCO**

Item	Pack	Part #	HDI #
<b>KW1</b>			
(1 per card) Michigan State	5	CK-KCKW1	445421
<b>SC1</b>			
(1 per card) Michigan State	5	CK-KCSC1	445647



**TEAM KEY BLANKS**

**ILCO**

Item	Pack	Part #	HDI #
5 keys per pack. Sold/Price per Pack			
<b>KW1</b>			
NFL Lions	10		445416
MLB Tigers	10		445417
NHL Red Wings	10		445419
<b>SC1</b>			
NFL Lions	10		445641
MLB Tigers	10		445642
NHL Red Wings	10		445643

**USA KEY BLANKS**



**ILCO**

Item	Pack	Part #	HDI #
10 keys per pack. Sold/Price per Pack			
KW1	5	SI-B-USA	445406
SC1	5	SI-B-USA	445638



**DONALD KEY BLANKS**

**ILCO**

Item	Pack	Part #	HDI #
Sold 1 per card.			
KW1	1	CK-KCKW	445006
SC1	1	CK-KCSC	445008



BUILDERS HARDWARE

**IN STOCK KEY BLANKS**

HDI #	Key Blank
445925	62-DT
450205	1007LA
450201	1502
445888	1793V
445015	AM-1
445020	AM-3
445021	AP-1
445022	AP-2
445023	AP-3
445024	AP-4
445025	AR-1
445030	AR-4
445035	B-1
445040	B-2
445045	B-4
445050	B-5
445055	B-10
445060	B-11
445065	B-16
445070	B-24
445080	B-44E
445081	B-44P
445085	B-45H
445086	B-45P
445090	B-46
445095	B-47K
445100	B-48A
445303	B-48P
445105	B-49B
445304	B-49P
445110	B-50C
445307	B-50P
445115	B-51D
445308	B-51P
445117	B-52
445118	B-53
445113	B-56
445114	B-57

HDI #	Key Blank
445122	B-63
445123	B-64
445142	B-65P
445124	B-65
445126	B-67
445154	B-68
445127	B-68P
445128	B-69
445129	B-72
445331	B-77
445112	B-77P
445132	B-78
445137	B-78P
445133	B-79
445136	B-80
445139	B-80P
445134	B-84
445141	B-84P
445143	B-86
445147	B-86P
445151	B-88P
445152	B-89
445153	B-89P
445156	B-91
445150	B-91P
445157	B-92
450209	B-93
445149	B-93P
4150204	B-96
445138	B-101
445159	B-102
445161	B-102P
445165	B106-P
445120	BE-2
445903	BMW-3
445904	BW-3P
445125	BN-1
445130	BO-1
445135	CG-1
445140	CG-16

HDI #	Key Blank
445145	CG-17
445160	CO-3
445170	CO-7
445180	CO-10
445190	CO-26
445195	CO-62
445200	CO-68
445205	CO-87
445206	CO-88
445210	CO-89
445215	CO-97
445225	CO-106
445920	DA-25
445922	DA-31
445923	DA-31P
445924	DA-34P
445226	DC-3
445235	DE-2
445240	DE-4
445250	DE-6
445252	DE-8
445255	DE-9
445260	EA-27
445285	EL-8
445299	ES-9
445309	EZ-1
445305	FA-2
445306	FA-3
445721	FIC-3
445315	FR-2
445310	H-6
445335	H-50
445340	H-51
445342	H-53
445341	H-54
445344	H-55
445343	1186TS-H56
445338	1186TSP-H56P
445345	H-59
445350	H-60

key blanks 10 per pkg      5 pkg per box  
 p = plastic head 5 per pkg



BUILDERS HARDWARE

IN STOCK KEY BLANKS

HDI #	Key Blank
445351	H-62P
445353	H-64
445348	H-65
445352	H-65P
445349	H-66
445347	H-67P
445366	H-71P
445354	H-75
445364	H-75P
445361	H-75FM
445357	H-76
445362	H-76P
445358	H-78
445359	H-78P
445941	HD-90
445942	HD-90P
445945	HD-91P
445946	HD-92
445948	HD-92P
445952	HD-103P
445302	HR-2
445954	HY-2
450214	IL-9
450200	IL-11
445360	IN-2
445365	IN-3
445375	IN-8
445380	IN-18
445382	IN-24
445385	IN-28
445390	IN-29
445395	IN-33
445397	IN-35
445405	K-2
445401	KK1P
445402	KK2P
445403	KK3P
445404	KK4P
445407	KW1-PC- Red
445408	KW1-PC- Blue
445409	KW1-PC- Green
445410	KW-1

HDI #	Key Blank
445414	KW1-PC- Ass't
445413	KW-5
445412	KW-10
445424	KW-11
445415	L-1
445425	LO-1
450203	L4
445430	M-1
450215	M1-PC
450212	M1-PC-ASS'T
445435	M-2
445436	M-3
445440	M-4
445441	M-5
445445	M-10
445450	M-11
445455	M-12
445460	M-13
445459	M-14
445461	M-16
450208	M-19
450206	M-20
450211	M-25
445462	MD-17
445463	MIT-1
445464	MIT-1P
445466	MIT-2
445465	MIT-3
445468	MIT-5
445950	MZ-5
445947	MZ-4
445962	MZ-13
445964	MZ-16
445968	MZ-17
445965	MZ-19
445969	MZ-19P
445966	MZ-27
445967	MZ-27P
450207	N54G-DL
445470	NA-1
445475	NA-6
445480	NA-12

HDI #	Key Blank
445481	NA-14
445482	NA-24
445483	NA-25
445490	OL-1
445515	RA-3
445520	RA-4
445530	RO-1
445535	RO-3
445540	RO-7
445565	RU-4
445545	RU-16
445580	RU-45
445585	RU-46
445600	S-4
450213	S-6
445622	S-22
445625	S-68
445651	SC1-PC- Red
445652	SC1-PC- Blue
445653	SC1-PC- Green
445635	SC-1
445637	SC1-PC- Ass't
445640	SC-4
445645	SC-6
445650	SC-7
445655	SC-8
445660	SC-9
445665	SC-10
450210	SC-20
445670	SC-22
445675	SE-1
445715	SK-1
445700	SL-1
445720	SUB-1
445725	T-7
445976	T-61C
445977	T-61F
445980	TR-25
445982	TR-28
445984	TR-33P
445983	TR-37
445986	TR-39





## BUILDERS HARDWARE

## IN STOCK KEY BLANKS

HDI #	Key Blank	HDI #	Key Blank
445989	TR-40P	445884	Y-154P
445991	TR-47	445887	Y-155
445985	TR-47P	445891	Y-155P
445987	TR-53	445889	Y-157
445727	V-35P	445894	Y-157P
445729	V-37P	445893	Y-159
445992	VL-8	445896	Y-159P
445996	VO-73	445890	Y-220
450216	VR-7	445770	Y-1
445730	VW-71A	445775	Y-1E
445740	WE-1	445780	Y-2
445750	WK-2	445790	Y-4
445751	WR-2	445791	Y-5
445755	WR-3	445795	Y-6
445760	WR-4	445810	Y-11
445765	WR-5	445815	Y-12
445766	WR5-PC	445820	Y-13
445770	Y-1	445825	Y-14
445775	Y-1E	445835	Y-52
445780	Y-2	445840	Y-54
445790	Y-4	445841	Y-78
445791	Y-5	445850	Y-103
445795	Y-6	445860	Y-138
445810	Y-11	445865	Y-146
445815	Y-12	445870	Y-149
445820	Y-13	445880	Y-152
445825	Y-14	445885	Y-153
445835	Y-52	445731	Y-153P
445840	Y-54	445886	Y-154
445841	Y-78	445884	Y-154P
445850	Y-103	445887	Y-155
445860	Y-138	445891	Y-155P
445865	Y-146	445889	Y-157
445870	Y-149	445894	Y-157P
445880	Y-152	445893	Y-159
445885	Y-153	445896	Y-159P
445731	Y-153P	445890	Y-220
445886	Y-154	445910	1601TM1



BUILDERS HARDWARE



EH3



EH3P



GTH

ELECTRONIC KEY HEAD

ILCO

Item	Pack	Part #	HDI #
They must be paired with an electronic key blade (sold separately) and cut on a standard key cutting machine. Electronic key head, use with electronic key blade (EB3) #A Y160, B H72, C H73, D H84, E TOY43, H N102, J MAZ24, K MIT8, L MIT9, M MIT14, and P SUB4.			
Electronic Key Head	1	EH3	450560
Used For Blade Portion Only Keys #EB3-F-TOY48, EB3-G-TOY40, EB3-R-B111, EB3-S-HO03, EB3-T-Y170, EB3-U-HD111, EB3-V-HU100, EB3-W-B114R, EB3-X-GM45, E			
Phillips Electronic Key Head	1	EH3P	450565
No Battery, no circuit board. Contains a glass transponder. Fits existing Ilco Modular System Key Blades. One head allows cloning of both TI and Phillips Crypto. Can be pre-coded (using TRP Setting Program) to emulate 14 different transponders. Utilizes security that protects against potential illegal cloning.			
Multi Transponder Head	5	GTH	450630



B97PT5



B99PT5



B103PT5



HD106PT5



NSN11T2



MAZ24RT5

TRANSPONDER KEY

ILCO

Item	Pack	Part #	HDI #
Transponder keys are devices designed to transmit a radio signal from a handheld device to a remote receiver.			
GM	1	B97PT5	450520
GM	1	B99PT5	450525
GM	1	B103PT5	450530
Daewoo	1	DW04RT5	450505
Daewoo	1	DW05RT5	450510
Daewoo	1	DW05T5	450515
Acura & Honda	1	HD106PT5	450545
GM	1	HU46T2	450535
Mazda	1	MAZ24RT5	450550
Nissan	1	NSN11T2	450555
GM & Others	1	PT04PT5-B107PT5	450540
Chrysler	1	YM15T5S1	450500

KEY BLADE



EB3-AY160

EB3-E-TOY43

ILCO

Item	Pack	Part #	HDI #
Automotive high security key blade for use with autos having anti theft systems. The electronic blade must be paired with an electronic key head			
Chrysler	1	EB3-AY160	450562
Ford	1	EB-B-H72	450567
Ford	1	EB3-C-H73	450570
Ford	1	EB3-D-H84	450575
Toyota	1	EB3-E-TOY43	450580
Nissan	1	EB3-H-N102	450585
Mazda	1	EB3-J-MAX24	450590
Mitsubishi	1	EB3-K-MIT8	450595
Mitsubishi	1	EB3-L-MIT9	450600
Mitsubishi	1	EB3-M-MIT14	450605
Subaru	1	EB3-P-SUB4	450610
GM	1	EB3-R-B111	450615
Chrysler	1	EB3-T-Y170	450617
Acura	1	EB3-U-HD111	450620
Saturn	1	EB3-W-B114R	450625



BUILDERS HARDWARE



**DOOR VIEWER  
NATIONAL**

Solid brass case. Optical glass lens.  
1/2" diameter.  
Carded

(405080) N158-907  
pk 5

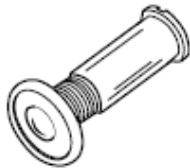

**DOOR VIEWER  
DON JO**

Satin Chrome Case  
9/16" installation hole  
180° view glass lens  
UL Rated

(427117) ULDV-180-626  
pk 10



**FINGER PULL  
DON-JO**

2 1/8"

Brass

(427021) 125-605

Oil Rub Bronze

(427022) 125-613

Satin Nickel

(427023) 125-619

pk 50



**HEAVY DUTY POCKET  
DOOR FRAME**

**LE JOHNSON**

For 1 3/8" door panels to 125#  
Standard 6' 8" height  
Packaged with hardware  
Features: Split jamb and uprights  
have full steel sides and back. Track  
is keyhole slotted for easy removal.  
Tricycle hangers. Self adjusting floor  
anchors.

Finished Opening Size - 3'  
Marked for cutting to other standard  
widths.

(466010) 153068PF  
pk 49

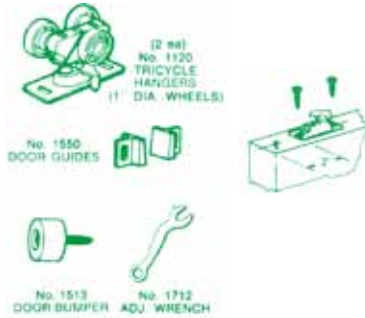

**POCKET DOOR  
HARDWARE SET**

**LE JOHNSON**

Hangers and guides for 1500, 2710  
series pocket frame

Carded

(466105) 1500-PPK3  
pk 10



**POCKET DOOR BUMPER  
& GUIDE SET**

**LE JOHNSON**

Fastens to pocket edge of door.  
Carded

(466145) 1505-PPK3  
pk 10



**ADAPTER KIT**

**LE JOHNSON**

Converts 1500 frame from 1 3/8" to  
1 3/4" thick doors  
Carded

(466095) 1575-PPK3  
pk 10

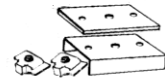

**CONVERGING DOOR  
CONNECTOR**

**LE JOHNSON**

Joins two pocket door frames  
For 1500, 2511, 2711 door frames  
Carded

(466085) 1555-PPK3  
pk 10



**DOOR KICK PLATE  
IVES**

.050 thickness. Protects against scuffing,  
pet damage and adverse weather.  
Suitable for wood or metal doors.  
Furnished with screws. Individually  
packaged.

8 x 34"  
Satin Nickel  
(428419) C8400B-619  
Antique Nickel Plate  
(428418) C8400B-620  
pk 5



BUILDERS HARDWARE

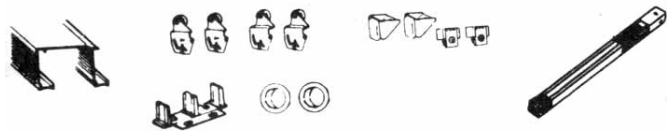

**BY-PASS DOOR HARDWARE**

**LE JOHNSON**

For 3/4 to 1-3/8" doors to 50# each. Aluminum track packaged with hardware.  
Features: Aluminum rails designed to prevent door from jumping track. Balanced wheels with reversible hangers. Quick adjust door guide.

48" [2 doors]	
(465970)	<u>2200482D</u>
60" [2 doors]	
(465973)	<u>2200602D</u>
pk 5	

72" [2 doors]	
(465976)	<u>2200722D</u>
96" [4 doors]	
(465979)	<u>2200964D</u>
pk 5	



**DOOR HANGER**

**LE JOHNSON**  
Universal for V track  
1/8" double wheel  
Carded

(466075)	<u>2312-PPK1</u>
pk 10	

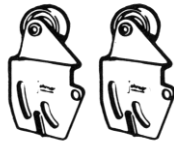

**SLIDING DOOR HANGER**

**LE JOHNSON**  
For Johnson convex track only. For doors to 50# each. 2 per card

1/16" offset	
(466015)	<u>2216-PPK2</u>
3/8" offset	
(466020)	<u>2238-PPK2</u>
pk 10	

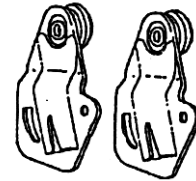

**SLIDING DOOR HANGER**

**LE JOHNSON**  
3/4" wheel for Sterling, M-D, National, Lawrence, Grant "V" track. 2 per card

3/8" offset	
(466050)	<u>2338-PPK2</u>
pk 10	

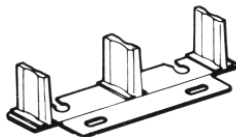

**SLIDING DOOR GUIDE**

**LE JOHNSON**  
Four way adjustment. 3/4 to 1-3/8" doors. 1 per card

(466055)	<u>2135-PPK1</u>
pk 10	

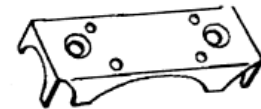

**SLIDING DOOR CARPET RISER**

**LE JOHNSON**  
For use with 2135 door guide. 1 per card

(466025)	<u>2136-PPK1</u>
pk 10	



BUILDERS HARDWARE

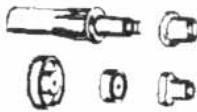

REPLACEMENT TOP GUIDE

LE JOHNSON

Item	Pack	Part #	HDI #
For Johnson, Acme, Alliance, Sterling, EZ Roll, Cox			
1 set per card	10	1832-PPK3	466060



PIVOT / GUIDE REPLACEMENTS

LE JOHNSON

Item	Pack	Part #	HDI #
For two doors. Use with 1800 series Johnson hardware sets.			
1 set per card	10	1806-PPK3	466140



PIVOT / GUIDE REPLACEMENTS

LE JOHNSON

Item	Pack	Part #	HDI #
For folding doors.			
1 set per card	10	1817-PPK3	466065



OIL RUBBED BRONZE - 920 & V980



STAINLESS STEEL - 922 & V982

SLIDING DOOR HARDWARE

NATIONAL HARDWARE

Item	Pack	Part #	HDI #
<b>72" Sliding Door Hardware</b> - Adds rustic appeal to interior door openings. Cost effective way to add style and privacy to an open doorway. Includes all mounting hardware and components to hang one interior door. Accommodates openings of up to 36-in wide; for openings wider than 36-in use multiple kits. For single doors 1 3/8-in and 1 3/4-in thick. Accommodates single doors up to 200 lbs. Includes detailed instructions for easy installation.			
920 - Oil Rubbed Bronze	1	N186-960	465980
922 - Stainless Steel	1	N186-962	465982
<b>Connecting Adapter</b> - Connects multiple flat tracks for door openings wider than 36 inches. Includes fasteners for quick and easy installation. Use with decorative sliding door hardware kit N186-960			
V980 - Oil Rubbed Bronze	3	N187-001	465981
V982 - Stainless Steel	3	N187-002	465983



**BUILDERS HARDWARE**



**REPLACEMENT PARTS SET**

LE JOHNSON

Item	Pack	Part #	HDI #
For 1700 series two door set.			
1 per card	10	1700-PPK3	466110

**FOLDING DOOR HINGE**



LE JOHNSON

Item	Pack	Part #	HDI #
Self spacing.			
2 per card	10	1805-PPK2	466120

**FOLDING DOOR KNOB**



LE JOHNSON

Item	Pack	Part #	HDI #
For 1 1/8" to 1 3/8" thick doors			
2 set per card	10	33-PPK2	466130

**CARPET RISER**



LE JOHNSON

Item	Pack	Part #	HDI #
Use with folding doors			
1 set per card	10	1836-PPK2	466030

**BI-FOLD DOOR ALIGNER**



LE JOHNSON

Item	Pack	Part #	HDI #
For four door units			
1 set per card	10	1808-PPK1	466070



**FOLDING DOOR HARDWARE**

LE JOHNSON

Item	Pack	Part #	HDI #
Top mount. For 2 - 4 door panels 1 1/8" to 1 3/4" thickness, to 35# each. Packaged with track and hardware. Features: Positive pivot lock, steel track, shock absorbing hinge, adjustable door bracket.			
<b>Two Doors</b>			
36"	5	1700363H	465988
<b>Four Doors</b>			
48"	5	1700486H	465992
60"	5	1700606H	465996
72"	5	1700726H	465998



**BUILDERS HARDWARE**



**ORNAMENTAL PULL  
NATIONAL V3**

Handle for gates, sheds, doors, etc.  
8 3/4".

**1 per card** with screws

Black finish

(465849) \_\_\_\_\_ N100-057

pk 5

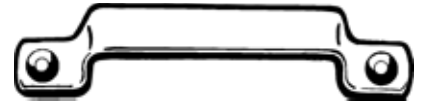

**UTILITY PULL  
NATIONAL V4**

Universal handle for general purpose  
use. 6 1/2".

**1 per card** with screws

Zinc finish

(465611) \_\_\_\_\_ N100-115

pk 5



**HEAVY DUTY PULL  
NATIONAL V171 & V172**

For screen, shed and barn doors. Rounded contour formed for  
maximum comfort and appearance.

POLY BAG w/fasteners

#2 5 1/2" 81-0530

(465314) SPB172 N226-860

pk 20

#3 6 1/2" 81-0560

(465316) SPB171 N226-845

pk 15

**V172 1 per card** with screws  
5 1/2" White

(465422) \_\_\_\_\_ N248-427

5 1/2" Zinc 75-1310

(465610) \_\_\_\_\_ N116-855

5 1/2" Brass 75-1300

(465615) \_\_\_\_\_ N116-889

5 1/2" Black 75-1311

(465617) \_\_\_\_\_ N116-830

**V171 1 per card** with screws  
6 1/2" Zinc 75-1320

(465620) \_\_\_\_\_ N116-715

6 1/2" Brass

(465613) \_\_\_\_\_ N116-764

6 1/2" Black

(465618) \_\_\_\_\_ N116-699

pk 5

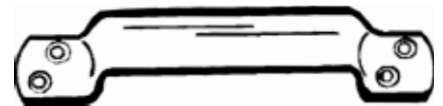

**HEAVY DUTY HANDLE  
NATIONAL V6**

For buildings, warehouse etc.  
6 3/4"

**1 per card** with screws

Zinc Finish

(465612) \_\_\_\_\_ N100-313

White vinyl coated

(465614) \_\_\_\_\_ N162-594

pk 5



BUILDERS HARDWARE



**RIGID HANGER  
W/OFFSET BOLT  
NATIONAL 5002**

Galvanized steel, for use on doors constructed of wood or metal. Both lateral and vertical adjustments. Bolt is all thread to be used with any size door member. For doors weighing up to 400#.

sold/price per pair

8050  
(490018) \_\_\_\_\_ N183-046  
pk 1



**RIGID HANGER WITH  
DROP STRAP  
NATIONAL 5005**

Galvanized steel for use on wood framed sliding doors. has both vertical and lateral adjustments. For doors weighing up to 400#.

sold/price per pair

8060  
(490019) \_\_\_\_\_ N112-102  
pk 1



**TROLLEY RAIL  
BOX STYLE  
NATIONAL 5116**

Galvanized steel rail for doors weighing up to 400# each when attaching brackets are spaced a maximum of 24" on center.

6' 8000-6  
(490001) \_\_\_\_\_ N105-676

8' 8000-8  
(490002) \_\_\_\_\_ N105-726

10' 8000-10  
(490003) \_\_\_\_\_ N105-213  
pk 4





BUILDERS HARDWARE

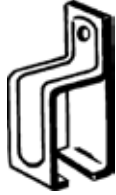

**SINGLE TROLLEY RAIL  
BRACKET**

**NATIONAL DP51FB**

Galvanized steel for use with box  
strack. Non adjustable. Recommend-  
ed spacing is 24". Furnished with 3/8  
x 2" lag screw.

8070

(490009)                      N104-349

pk 10



**SINGLE TROLLEY RAIL  
SPLICE BRACKET**

**NATIONAL DP51GBC**

Galvanized steel. For use with box  
series trolley rail. Use at all splices  
where a nonadjustable bracket is  
required. One bracket is required at  
each splice and at the end of the trol-  
ley rail run. Furnished with 3/8 x 2"  
lag screw.

8071

(490017)                      N104-380

pk 10



**BUILDERS HARDWARE**



**OPEN BAR HOLDER  
NATIONAL 15**

For use with a length of 2 x 4" lumber to secure garage, shed, store room and small warehouse doors. Zinc plated. No fasteners furnished.

8162  
(490011) \_\_\_\_\_ N100-792  
pk 10



**CLOSED BAR HOLDER  
NATIONAL 14**

For use with a length of 2 x 4 lumber to secure garage, shed, store room and small warehouse doors. Zinc plated. No fasteners furnished.

8161  
(490012) \_\_\_\_\_ N100-743  
10

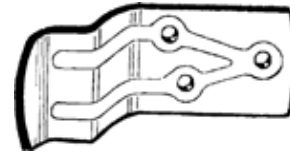

**DOOR STOP  
NATIONAL DP17BC**

Strong-stamped steel door stop. For any sliding door installation. Zinc plated. No fasteners furnished.

8116  
(490021) \_\_\_\_\_ N100-834  
pk 5

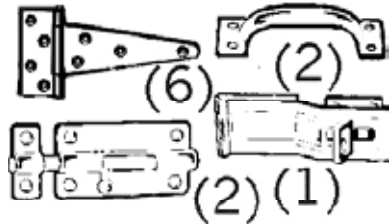

**BARN HARDWARE KIT  
NATIONAL (BARNKIT)**

Storage barn kit contains 2 door pulls, 6 T-hinges, 2 barrel bolts, 1 hasp and screws

Zinc Finish  
(465498) \_\_\_\_\_ N219-592  
pk 1



**JAMB LATCH  
NATIONAL 1264**

Adjustable latch designed to snug door to building. Galvanized. No fasteners furnished. 7" Size

(490020) \_\_\_\_\_ N161-760  
pk 1

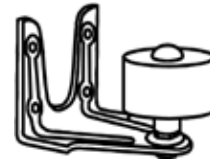

**STAY ROLLER  
NATIONAL DP18BC**

Ideal for smaller doors. Steel frame provides strength for most installations. Adjustable and reversible. Zinc plated

8111  
(490015) \_\_\_\_\_ N100-875  
pk 5



BUILDERS HARDWARE

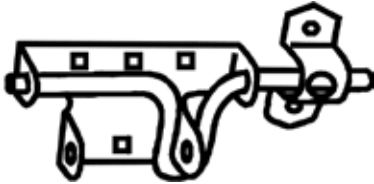

**SLIDE ACTION BOLT  
NATIONAL V1134**

For use on inswinging and outswinging gates and doors. Can be used on round or flat post applications. Reversible for right or left hand operation. Can be padlocked.

**1 per card** with screws

Zinc	76-0814
(465855)	<u>N165-555</u>
Black Finish	76-0815
(465860)	<u>N165-506</u>

pk 5

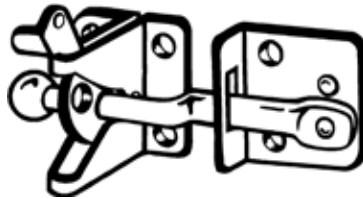

**GATE LATCH -  
ADJUSTOMATIC  
NATIONAL V21A**

For latching single acting gates and doors. Self-latching, released by raising tip. 4" Padlock eye for security.

**1 per card** with screws

Zinc	N101-253
(465851)	<u>N342-618</u>
Satin Black	76-0825
(465850)	<u>N342-626</u>

pk 5

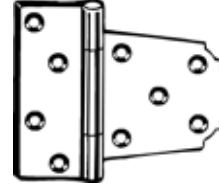

**HEAVY DUTY GATE  
HINGE  
NATIONAL 287**

Designed for narrow mounting surfaces, gates, barn and shed doors.

**Bulk** without screws

Zinc plated  
3 1/2"  
(465530) N223-875  
Black Finish  
3 1/2"  
(465529) N223-867  
pk 10

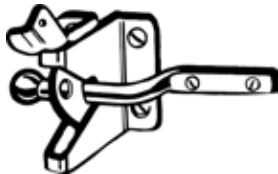

**GATE LATCH  
NATIONAL V21**

For latching single acting gates and doors. Self-latching release by raising tip. Can be padlocked.

**1 per card** with screws

Zinc Finish	76-3825
(465845)	<u>N101-162</u>

pk 5

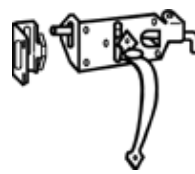

**GATE THUMB LATCH  
NATIONAL V27**

For ornamental gates from gardens, patios, swimming pools, etc. For gates 1 1/2" to 3" thick. Reversible for right or left hand applications. Equipped with locking feature.

**1 per card** with screws

Satin black	
10 13/32"	76-0830
(465865)	<u>N178-616</u>

pk 3



**WOOD SCREW FOR GATE  
HINGE #287  
NATIONAL V286S**

12 x 1 1/4"

18 screws per card

Zinc plated  
(465532) N223-982  
Black finish  
(465531) N224-386  
pk 5



BUILDERS HARDWARE

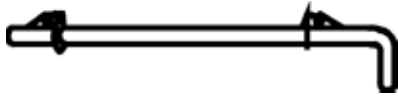

**CANE BOLT**  
**NATIONAL V836**

Use to secure doors and gates in open or closed positions.  
1/2 x 12"

**1 per card** with screws

Zinc plated

(465872) \_\_\_\_\_ N152-058  
pk 5

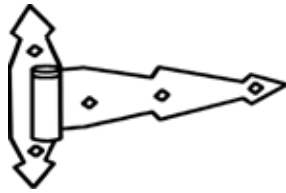

**ORNAMENTAL TEE HINGE**  
**NATIONAL V849**

For ornamental gates from patios, pools, etc. Heavy gauge steel for long wearing service. Zinc plated before final finish for durability. Loose pin reversible for right or left hand applications.

**2 per card** with fasteners  
Black finish

7" \_\_\_\_\_ 76-0840  
(465870) \_\_\_\_\_ N165-480  
pk 3



**ANTI-SAG GATE KIT**  
**NATIONAL V852**

Designed to prevent or correct sagging gates up to 7 1/2'. Diagonal bracing kit includes corner bracket, rope clip, cable and turnbuckle.

**1 per card** with screws

(465295) \_\_\_\_\_ N192-211  
pk 5

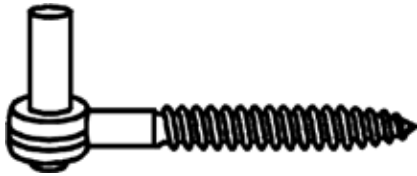

**SCREW HOOK**  
**NATIONAL 291BC**

Made from malleable iron. Designed for use on gates of patios, gardens and swimming pools. For mounting to square or round fence posts.

5/8 x 5" \_\_\_\_\_ 57-5845  
(465286) \_\_\_\_\_ N130-146  
pk 10

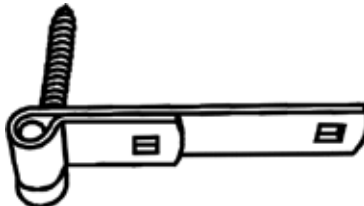

**SCREW HOOK & STRAP HINGE**  
**NATIONAL 290BC**

Especially designed for use with cedar posts, gates, etc. Heavy duty steel.

Pair per poly bag.  
**sold/price pair**

Zinc US2C  
6" \_\_\_\_\_ 57-2470  
(465276) \_\_\_\_\_ N130-005  
8" \_\_\_\_\_ 57-2560  
(465278) \_\_\_\_\_ N130-054  
10" \_\_\_\_\_ 57-2650  
(465280) \_\_\_\_\_ N129-726  
pk 5



**SCREW HOOK & STRAP HINGE**  
**EAGLE HARDWARE**

Designed for use with cedar posts, gates, etc.

**sold/price each**

Plain steel  
8" \_\_\_\_\_ 6973-8  
pk 10



# GARAGE DOOR PART REFERENCE

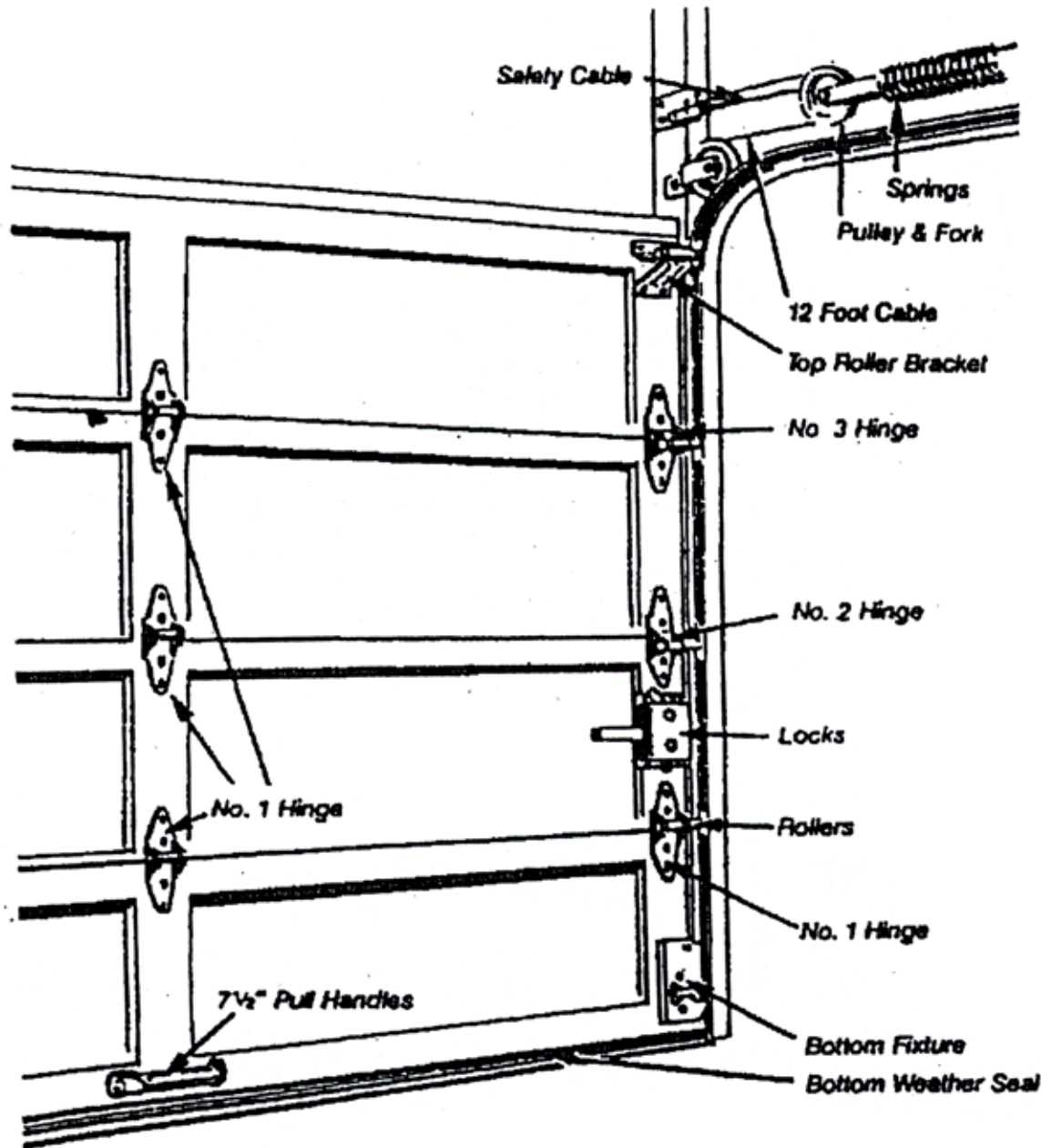



BUILDERS HARDWARE



**NO. 1 HINGE**

National V7608  
14 ga galvanized steel. Hinge for first section joint and all other hinge joints without rollers. Universal for all wood and metal doors. Bolts and nuts included.

(470020) GD52104  
pk 4 N280-156



**NO. 2 HINGE**

NATIONAL 7909  
14 ga galvanized steel. Hinge for second joint of wood and metal doors. Bolts and nuts included.

(470025) GD52105  
pk 4 N280-172



**NO. 3 HINGE  
PRIME-LINE**

14 ga galvanized steel. Hinge for third section joint of wood and metal doors. Bolts and nuts included.

(470030) 00604  
pk 6 GD52106



**RIGHT SIDE BOTTOM  
FIXTURE  
PRIME-LINE**

Universal galvanized steel bottom fixture for wood and steel doors. Accepts 9' torsion cables or 12' extension cables. Bolts and nuts included.

(470007) 00628  
pk 6 GD52115

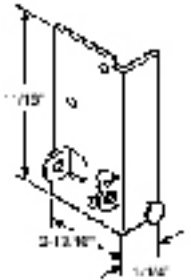

**LEFT SIDE BOTTOM  
FIXTURE  
PRIME-LINE**

Universal galvanized steel bottom fixture for wood and steel doors. Accepts 9' torsion cables or 12' extension cables. Bolts and nuts included.

(470005) 00626  
pk 6 GD52116



**TOP ROLLER BRACKET  
PRIME-LINE**

14 ga galvanized steel. Adjustable. Universal fit for all wood and metal doors. Bolts and nuts included.

(470035) 00614  
pk 6 GD52117



**9' CABLES  
NATIONAL V7618**

9' lengths 7 x 7-1/8 galvanized aircraft cable for use on doors with torsion spring set-up. One end of each looped and secured with cable sleeve. Oval stops included for securing other end. Pair per pkg.

(470087) GD52183  
pk 4 N280-362



**12' CABLES  
NATIONAL V7617**

12' lengths of 7 x 7-1/8 galvanized aircraft cable for use on doors with extension spring set-up. One end of each looped and secured. Pair per pkg.

(470050) GD52100  
pk 4 N280-313

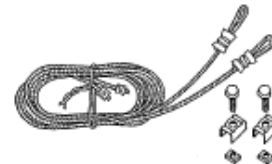

**SAFETY CABLES  
NATIONAL V7619**

9' lengths of 7 x 7-1/8 galvanized aircraft cable for use on all extension springs. Cables have special fittings on each end for securing properly. Safety cables should be used on all extension springs. Pair per pkg.

(470085) GD52102  
pk 4 N280-388



**BUILDERS HARDWARE**

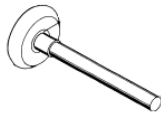

**1 7/8" STEEL ROLLERS**

**NATIONAL 7602**

10 ball bearing heavy duty steel rollers  
7/16" stem diameter  
4 3/8" stem length  
Pair per pkg

(470000) \_\_\_\_\_ GD52110  
pk 4 N280-057

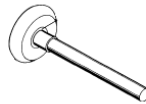

**1 3/4" NYLON ROLLERS**

**NATIONAL V7605**

Heavy duty polyurethane rollers for  
quiet door operation. 7/16" stem  
diameter. 4 1/2" stem length. Pair  
per pkg.

(470003) \_\_\_\_\_ N280-123  
pk 4



**T-LOCK HANDLE**

**NATIONAL V7640**

Locking chrome T-handle with two  
keys. Lock comes with 5/16" square  
shank and works in combination with  
swivel or lock bar disc.

(470100) \_\_\_\_\_ GD52122  
pk 3 N280-610

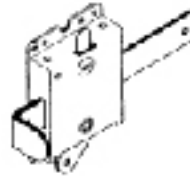

**INTERIOR SLIDE LOCK**

**NATIONAL V7647**

Galvanized steel interior lock with  
spring loaded hardened bolt for thru  
track locking. Works in combination  
with lock handle set of L-handle and  
lock cylinder.

(470090) \_\_\_\_\_ GD52138  
pk 3 N280-743



**PULL HANDLES**

**NATIONAL V7638**

Galvanized steel utility handles  
7-5/16" length  
Furnished with bolts and nuts. Pair  
per pkg.

(470080) \_\_\_\_\_ GD52130  
pk 4 N280-586



BUILDERS HARDWARE



**PULLEY WITH STRAP  
AND AXLE BOLT  
NATIONAL 7633**

3" Heavy duty galvanized steel pulley with galvanized steel strap. Case hardened steel race with steel ball bearings, can be used stationary or spring pulley positions.  
Contains 1 pulley, 1 strap and 1 axle bolt with nut.

3" GD-52109  
(470057) N280-552  
pk 5

4" GD-52108  
(470055) N280-537  
pk 4

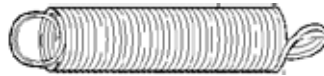

**70# EXTENSION SPRING  
W/CABLE  
NATIONAL 7687**

10,000 cycle heavy duty extension springs. Use on single car fiberglass doors.  
8' x 6'6" and 8' x 7' or 9' x 7' fiberglass doors. Orange

GD-12202  
(470058) N281-006  
pk 1

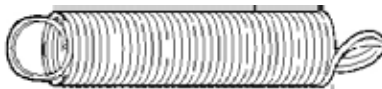

**110# EXTENSION SPRING  
W/CABLE  
NATIONAL 7688**

10,000 cycle.  
Wood door 8'W x up to 6'5" high, 2 panels - 4 sections.  
Fiberglass door 16'W x up to 7' high, 4 sections. White

GD-12191  
(470059) N281-022  
pk 1



**130# EXTENSION SPRING  
W/CABLE  
NATIONAL 7690**

10,000 cycle.  
Wood door 8'W x 7' High;  
4 panels - 4 sections. Yellow

GD-12193  
(470060) N281-071  
pk 1

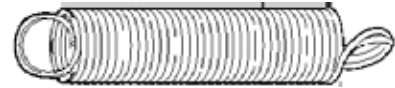

**140# EXTENSION SPRING  
W/CABLE  
NATIONAL 7690**

10,000 cycle heavy duty extension springs. Wood door 9'W x 7' high 2 panels - 4 sections. Wood door 16'W x 7' high; 2 panels - 4 sections. Blue

GD-12194  
(470065) N281-089  
pk 1

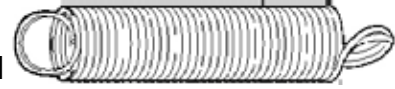

**1  
W/CABLE  
NATIONAL 7690**

10,000 cycle.  
Wood door 9'W x 7' high;  
4 panels - 4 sections. Wood door 16'W x 7' high; 4 panels - 4 sections. Red

GD-12195  
(470070) N281-105  
pk 1





BUILDERS HARDWARE



**UNIVERSAL PIN PADLOCKS & KEYING TOOL**

**MASTER LOCK**

Item	Pack	Part #	HDI #
<ul style="list-style-type: none"> <li>Locks pinned to customer's key in minutes</li> <li>Operates with same key as Master Lock padlocks Nos. 1-6</li> <li>Laminated steel body for superior strength</li> <li>Hardened steel shackle for superior cut resistance</li> <li>4-pin tumbler cylinders helps prevent picking</li> <li>Great choice for keyed alike applications</li> <li>Use No. 376 Universal Pin Keying Tool</li> </ul>			
<b>1 3/4" Body, 5/16" Shackle Diameter</b>			
15/16" Shackle Length	6	1UP	460011
2 1/2" Shackle Length	6	1UPLJ	460012
<b>1 9/16" Body, 9/32" Shackle Diameter</b>			
3/4" Shackle Length	6	3UP	460052
1 1/2" Shackle Length	6	3UPLF	460053
<b>2" Body, 9/32" Shackle Diameter</b>			
1" Shackle Length	6	5UP	460081
1 1/2" Shackle Length	6	5UPLF	460082
<b>Padlock Keying Tool</b>			
<ul style="list-style-type: none"> <li>Produces custom-pinned locks in minutes</li> <li>Keying tool for on-site use with Universal Pin Padlocks</li> </ul>			
	1	376	460300



**LAMINATED STEEL PIN TUMBLER PADLOCKS - GENERAL SECURITY**

*\*Keyed different unless noted*

**MASTER LOCK**

Item	Pack	Part #	HDI #
<ul style="list-style-type: none"> <li>Laminated steel body for superior strength</li> <li>Standard steel shackle</li> <li>4-pin cylinder helps prevent picking</li> <li>Minimal clearance helps prevent prying</li> <li>More than 1,500 key changes for maximum pick resistance</li> </ul>			
<b>No. 7 Padlocks, 1 1/8" Body, 3/16" Shackle Dia.</b>			
9/16" Shackle, Carded	6	7D	460085
9/16" Shackle, Keyed Alike	6	7KA	460090



**Thermoplastic Cover**

**LAMINATED STEEL PIN TUMBLER PADLOCKS**

*\*Keyed different unless noted*

**MASTER LOCK**

Item	Pack	Part #	HDI #
<ul style="list-style-type: none"> <li>Laminated steel body for superior strength</li> <li>Hardened steel shackle for extra cut resistance</li> <li>4-pin cylinder helps prevent picking</li> <li>Dual locking levers provide extra pry resistance</li> <li>More than 3,000 key changes for maximum pick resistance</li> </ul>			
<b>No. 1 Padlocks, 1 3/4" Body, 5/16" Shackle Diameter</b>			
15/16" Shackle, Carded	6	1D	460005
15/16" Shackle, Keyed Alike	6	1KA	460010
1 1/2" Shackle, Keyed Alike	6	1KALF	460020
2 1/2" Shackle, Carded	6	1DLJ	460033
2 1/2" Shackle, Keyed Alike	6	1KALJ	460030
2 1/2" Shackle, Keyed Alike 3 Pack Carded	6	1TRILJ	460034
<b>No. 3 Padlocks, 1 9/16" Body, 9/32" Shackle Dia.</b>			
3/4" Shackle, Carded	4	3D	460045
3/4" Shackle, Keyed Alike	6	3KA	460050
3/4" Shackle, Keyed Alike Twin Pack Carded	4	3T	460047
3/4" Shackle, Keyed Alike 4 Pack Carded	4	3008D	460051
1 1/2" Shackle, Carded	4	3DLF	460073
1 1/2" Shackle, Keyed Alike	6	3KALF	460070
2" Shackle, Keyed Alike	6	3KALH	460060
<b>No. 3 Padlocks, Thermoplastic Cover</b>			
3/4" Shackle, Carded	4	312D	460046
3/4" Shackle, Keyed Alike 3 Pack Carded	4	312TRI	460054
<b>No. 5 Padlocks, 2" Body, 3/8" Shackle Diameter</b>			
1" Shackle, Carded	4	5D	460075
1" Shackle, Keyed Alike	6	5KA	460080
1 1/2" Shackle, Carded	4	5DLFPF	460083

**Key Numbers In Stock:**

- 1KA Padlocks: 2001, 2002, 2396, 2402
- 3KA Padlocks: 0356, 0464, 0633, 0653, 3206, 3210, 3753
- 5KA Padlocks: A272
- 7KA Padlocks: P150



BUILDERS HARDWARE



**WARDER PADLOCKS**

*\*Keyed different unless noted*

**MASTER LOCK**

Item	Pack	Part #	HDI #
<b>Standard Warded Padlocks</b>			
<ul style="list-style-type: none"> <li>Laminated steel body</li> <li>Steel shackle provides strong cut resistance</li> <li>Warded locking mechanism minimizes jamming from dirt and grime</li> </ul>			
<b>No. 10 Padlocks, 1" Body, 5/32" Shackle Diameter</b>			
7/16" Shackle, Carded	4	10D	460105
<b>No. 105 Padlocks, 1 1/8" Body, 3/16" Shackle Dia.</b>			
1/2" Shackle, Carded	4	105D	460185
1/2" Shackle, Keyed Alike	6	105KA	460190
<b>No. 22 Padlocks, 1 1/2" Body, 1/4" Shackle Diameter</b>			
5/8" Shackle, Carded	4	22D	460135
5/8" Shackle, Keyed Alike	12	22KA	460140
5/8" Shackle, Keyed Alike Twin Pack Carded	4	22T	460141
<b>No. 500 Padlocks, 1 3/4" Body, 9/32" Shackle Dia.</b>			
13/16" Shackle, Carded	4	500D	460230
13/16" Shackle, Keyed Alike	12	500KA	460235
<b>Adjustable Warded Padlock</b>			
<ul style="list-style-type: none"> <li>Removable adjustable shackles provide maximum application flexibility</li> <li>Warded locking mechanism minimizes jamming from dirt and grime</li> <li>Adjustable shackle ensures snug fit to the locked item</li> </ul>			
<b>No. 510 Padlocks, 1 3/4" Body, 9/32" Shackle Dia.</b>			
5/8" - 2" Shackle, Carded	4	510D	460240
5/8" - 2" Shackle Keyed Alike	4	510KAD	460245
<b>No. 517 Padlock, 1 3/4" Body, 9/32" Shackle Dia.</b>			
2 3/4" - 5 3/8" Shackle, Carded	4	517D	460315



**ARMORLOCK PADLOCK**

**MASTER LOCK**

Item	Pack	Part #	HDI #
Specialty lock. Shackle guard and pin tumbler design offers extra protection against saws and bolt cutters. Shackle fits openings 15/16" in diameter. 4 pin cylinder. 1 1/2" body width. 9/32" shackle diameter.			
15/16" Shackle	6	37KA	460150

**SHROUDED PADLOCKS**



**MASTER LOCK**

Item	Pack	Part #	HDI #
<b>EX SERIES</b>			
<ul style="list-style-type: none"> <li>EXtra security, EXtra strong</li> <li>Fully shrouded body for additional pry and cut resistance</li> <li>Laminated steel body for superior strength</li> <li>Hardened steel shackle</li> <li>4-pin cylinder helps prevent picking</li> </ul>			
1 3/4" Body, 5/16" Shackle	4	1DEX	460006
<b>Fusion Padlocks</b>			
<ul style="list-style-type: none"> <li>Front access keyway for ease of use</li> <li>Shrouded shackle protects against cutting</li> <li>Available in multiple colors</li> <li>Matching covered key heads for easy identification</li> </ul>			
2" Body, 5/8" - 1 1/2" Shackle	6	194D	460415



**GUARD**

Item	Pack	Part #	HDI #
<ul style="list-style-type: none"> <li>Solid Brass 5 Pin Tumbler Cylinder</li> <li>Hardened Steel Case &amp; Shackle</li> <li>Pick Proof</li> </ul>			
Guard - 2 3/4	6	242KA	394235



BUILDERS HARDWARE



No. 120, 130,  
140, 150



576DLHPF

SOLID BRASS PADLOCKS

MASTER LOCK

Item	Pack	Part #	IBM #
<b>General Security</b>			
<ul style="list-style-type: none"> <li>Stylish and strong solid brass lock body</li> <li>Brass, standard steel and hardened steel shackles</li> </ul>			
<b>No. 120 Padlock, 3/4" Body, 5/32" Shackle Diameter Standard Steel Shackle</b>			
7/16" Shackle, Carded	4	120D	460195
7/16" Shackle, Twin Pack - Carded	4	120T	460196
<b>No. 130 Padlock, 1 3/16" Body, 3/16" Shackle Dia. Hardened Steel Shackle</b>			
5/8" Shackle, Carded	4	130D	460200
<b>No. 140 Padlock, 1 9/16" Body, 1/4" Shackle Dia. Hardened Steel Shackle</b>			
7/8" Shackle, Carded	4	140D	460210
<b>No. 150 Padlock, 2" Body, 9/32" Shackle Diameter Hardened Steel Shackle</b>			
1" Shackle, Carded	4	150D	460220
<b>High Security</b>			
<ul style="list-style-type: none"> <li>Hardened steel shackle for superior cut resistance</li> <li>Dual ball bearing locking for maximum protection from prying and hammering</li> <li>5-pin cylinder for maximum pick resistance</li> </ul>			
<b>No. 576DLHPF Padlock, 1 3/4" Body, 5/16" Shackle Dia</b>			
2" Shackle, Carded	4	576DL-HPF	460244



RUSTOLEUM LAMINATED PADLOCKS

MASTER LOCK

Item	Pack	Part #	IBM #
<ul style="list-style-type: none"> <li>Rust-Oleum® certified protection guarantees the lock body from rusting</li> <li>Hardened steel shackle for superior cut resistance</li> <li>Dual locking levers provide extra pry resistance</li> <li>4-pin cylinder helps prevent picking</li> </ul>			
<b>No. 380 Padlock, 1 9/16" Body, 9/32" Shackle Dia.</b>			
1 1/8" Shackle, Carded	4	380D	460225



132DCM 141D 911DPF 527  
COVERED PADLOCKS

MASTER LOCK

Item	Pack	Part #	IBM #
<ul style="list-style-type: none"> <li>Blue vinyl covered body for scratch resistance</li> <li>Made of corrosion resistant materials</li> <li>Hardened steel shackle for extra cut resistance</li> <li>4-pin cylinder for added pick resistance</li> <li>Matching colored key head for added convenience</li> </ul>			
<b>No. 132DCM Padlock, 1 3/16" Body, 3/16 Shackle Dia</b>			
5/8" Shackle, Carded	4	132DCM	460205
<ul style="list-style-type: none"> <li>Black vinyl covered body for scratch resistance</li> <li>Made of corrosion resistant materials</li> <li>Hardened steel shackle for extra cut resistance</li> <li>4-pin cylinder for added pick resistance</li> <li>Matching colored key head for added convenience</li> </ul>			
<b>No. 141 Padlock, 1 9/16" Body, 1/4" Shackle Dia.</b>			
7/8" Shackle, Carded	4	141D	460215
<b>Weatherproof - Rekeyable</b>			
<ul style="list-style-type: none"> <li>Weatherproof cover and keyway protection</li> <li>Hardened boron alloy shackle for maximum cut resistance</li> <li>5-pin cylinder for superior pick resistance</li> <li>Dual ball bearing locking for maximum pry resistance</li> <li>FlexFit™ keyway cover minimizes jamming</li> <li>Removable cylinder - ability to rekey your lock</li> </ul>			
<b>No. 911 Padlock, 2 1/8" Body, 5/16" Shackle Dia.</b>			
1 1/8" Shackle, Carded	4	911DPF	460248
<b>Adjustable Shackle</b>			
<ul style="list-style-type: none"> <li>Removable adjustable-length shackle</li> <li>Vinyl-clad steel shackle helps prevent surface marring</li> <li>4-pin cylinder for added pick resistance</li> </ul>			
<b>No. 527 Padlock, 2" body, 5/16" Shackle Dia</b>			
2 3/8" Shackle, Carded	4	527D	460239



BUILDERS HARDWARE



**SOLID STEEL PADLOCKS**

**MASTER LOCK**

Item	Pack	Part #	HDI #
<b>Chrome Steel</b>			
<ul style="list-style-type: none"> <li>• Chrome plated solid steel lock body is strong, durable and resists rust and corrosion</li> <li>• Hardened steel shackle for superior cut resistance</li> <li>• Dual ball bearing locking for maximum protection from prying and hammering</li> <li>• 5-pin cylinder for maximum pick resistance</li> </ul>			
<b>No. 532 Padlock, 2" Body, 3/8" Shackle Dia.</b>			
1 1/4" Shackle, Carded	4	532DPF-SEN	460241
<b>Contractor Grade</b>			
<ul style="list-style-type: none"> <li>• Dual ball bearing locking for maximum protection from prying and hammering</li> <li>• Hardened boron alloy shackle for maximum cut resistance</li> <li>• 5-pin tumbler cylinder for added security</li> <li>• Removable cylinder - ability to rekey your lock</li> </ul>			
<b>No. 930 Padlock, 2 1/2" Body, 7/16" Shackle Dia.</b>			
2" Shackle, Carded	4	930DL-HPF	460249

**SOLID ALUMINUM PADLOCKS**



**MASTER LOCK**

Item	Pack	Part #	HDI #
<ul style="list-style-type: none"> <li>• Solid aluminum body is lightweight, durable and resists corrosion</li> <li>• Hardened steel shackle for superior cut resistance</li> <li>• Dual ball bearing locking for maximum protection from prying and hammering</li> <li>• 5-pin cylinder for maximum pick resistance</li> <li>• Key retaining feature ensures padlock is not left unlocked</li> </ul>			
<b>No. 570 Padlock, 1 1/2" Body, 9/32" Shackle Dia.</b>			
2" Shackle, Carded	4	570DL-HPF	460243



**TITANIUM SERIES PADLOCK**

**MASTER LOCK**

Item	Pack	Part #	HDI #
<ul style="list-style-type: none"> <li>• Titanium Series™ shrouded padlocks reinforced for maximum strength</li> <li>• "Bolt Cutter Tough" and "Crowbar Resistant" hardened steel shrouded shackle offers extreme cut and pry resistance</li> <li>• Weather Tough™ sliding keyway cover keeps dirt and grime from jamming the locking mechanism</li> <li>• Scratch proof and durable ABS plastic bumper</li> <li>• Stainless steel construction -No Rust Lifetime Guarantee</li> <li>• Key retaining feature ensures padlock is not left unlocked</li> </ul>			
<b>No. 185 Padlock, 1 15/16" Body, 9/32" Shackle Dia</b>			
5/8" Shackle, Carded	4	185D	460224
<b>No. 187 Padlock, 2 5/16" Body, 5/16" Shackle Dia</b>			
15/16" Shackle, Carded	4	187XD	460223



**TSA ACCEPTED PADLOCKS**

**MASTER LOCK**

Item	Pack	Part #	HDI #
<b>Luggage Lock</b>			
<ul style="list-style-type: none"> <li>• Allows TSA screeners to inspect and relock baggage, without damaging the lock</li> <li>• Keyed alike - same key opens all four locks</li> <li>• Solid metal body</li> </ul>			
<b>No. 4683 Padlock, 7/8" Body, 3/32" Shackle Dia</b>			
7/16" Shackle, 4 per Carded Keyed Alike	4	4683Q	460277
<b>Combination Luggage Lock</b>			
<ul style="list-style-type: none"> <li>• Allows TSA screeners to inspect and relock baggage, without damaging the lock</li> <li>• 4 dial, set-your-own combination convenience</li> <li>• Easy to set &amp; reset</li> <li>• Unique side window for easy combination viewing</li> </ul>			
<b>No. 4680 Padlock, 1 3/16" Body, 1/8" Shackle Dia.</b>			
3/4" Shackle, Carded	4	4680DNKL	460278



**COMBINATION PADLOCKS**

**MASTER LOCK**

Item	Pack	Part #	HDI #
<ul style="list-style-type: none"> <li>World's best selling combination lock</li> <li>Patent Pending BlockGuard® Anti-Shim Technology withstands attempts to violate the latch mechanism</li> <li>Easy 3-number dialing with automatic scrambling feature to prevent reopening of lock</li> </ul>			
<b>No. 1500 Padlock, 1 7/8" Body, 9/32" Shackle Dia</b>			
3/4" Shackle, Carded	6	1500D	460250
1-7/8-inch wide body 2-pack	4	1500T	460251
<b>Adjustable Shackle</b>			
<ul style="list-style-type: none"> <li>Removable adjustable-length shackle provides maximum application flexibility</li> <li>Vinyl covered shackle prevents scratches</li> <li>Combination security for keyless convenience</li> <li>3-digit dialing</li> <li>Hardened steel shackle for extra cut resistance</li> </ul>			
<b>No. 1517 Padlock, 1 7/8" Body, 9/32" Shackle Dia</b>			
4 1/2" - 4 3/4" Shackle, Carded	6	1517D	460320
<b>Password Plus Combination Locks - Assorted Colors</b>			
<ul style="list-style-type: none"> <li>Easy to set &amp; reset - use letters, numbers, symbols or mix them!</li> <li>Interchangeable, removable dials offer over 25 million personalized combinations</li> <li>5 position combination allows for maximum customization</li> <li>Soft touch dials with 2 grip points for no-slip grip</li> <li>Hardened steel shackle for extra cut resistance</li> </ul>			
<b>No. 1534 Padlock, 2 1/2" Body, 1/4" Shackle Dia.</b>			
1 1/8" Shackle, Carded	4	1534D	460256



**SOLID BRASS COMBINATION PADLOCKS**

**MASTER LOCK**

Item	Pack	Part #	HDI #
<ul style="list-style-type: none"> <li>Set your own 4 digit combination for convenience &amp; security</li> <li>Solid brass case for strength &amp; weatherability</li> <li>Hardened steel shackle for cut resistance</li> </ul>			
<b>No. 175 Padlock, 2" Body, 5/16" Shackle Dia</b>			
1" Shackle, Carded	6	175D	460385
<b>No. 177 Padlock, 2" Body, 5/16" Shackle Dia.</b>			
1" Shackle, Shrouded, Carded	6	177D	460226



**COMBINATION LUGGAGE LOCK**

**MASTER LOCK**

Item	Pack	Part #	HDI #
<ul style="list-style-type: none"> <li>Set-your-own combination convenience</li> <li>Easy to set &amp; reset</li> <li>Durable metal body with upscale black finish</li> <li>Steel shackle for cut resistance</li> </ul>			
<b>No. 646 Padlock, 13/16" Body, 1/8" Shackle Dia</b>			
11/16" Shackle, Carded	4	646D	460246



BUILDERS HARDWARE



CABLE & CHAIN LOCKS

MASTER LOCK

Item	Pack	Part #	HDI#
<b>3' Cable with Keyed Padlock</b> <ul style="list-style-type: none"> <li>Keyed cable lock</li> <li>1-1/8" (29mm) laminated steel body for superior strength</li> <li>3' (0.9m) long x 3/16" (5mm) diameter steel cable with protective vinyl sleeve</li> </ul>			
4-Pin Cylinder	6	719D	460360
<b>4' Cable with Barrel Combination Lock</b> <ul style="list-style-type: none"> <li>Fixed combination cable lock</li> <li>Combination locking mechanism for keyless convenience</li> <li>4' (1.2m) long x 5/16" (8mm) diameter cable</li> <li>Flexible steel cables for strong cut resistance</li> <li>Protective vinyl coating helps prevent scratching</li> </ul>			
	6	8143D	460345
<b>5' Cable with Barrel Combination Lock</b> <ul style="list-style-type: none"> <li>Set-your-own combination cable lock</li> <li>Combination locking mechanism for keyless convenience</li> <li>Easy to set and reset</li> <li>5' (1.5m) long x 3/8" (10mm) diameter flexible steel cable for strong cut resistance</li> <li>Protective vinyl coating helps prevent scratching</li> </ul>			
	4	8119DPF	460362
<b>6' Python Adj. Keyed Cable Lock</b> <ul style="list-style-type: none"> <li>6-foot adjustable locking cable</li> <li>Multipurpose lock for bikes, grills, trailers, ladders, chain-link applications</li> <li>Patented locking mechanism adjusts from 1 to 6 feet and holds steel cable tight</li> <li>Re-keyable cylinders for keyed alike convenience</li> <li>3/8-inch cable; lifetime warranty</li> </ul>			
	4	8413XDPF	460395

CABLE & CHAIN LOCKS

MASTER LOCK

Item	Pack	Part #	HDI #
<b>6' Looped End Cable</b> <ul style="list-style-type: none"> <li>6' (1.8m) long x 3/8" (10mm) diameter looped end cable</li> <li>Ideal for securing large or bulky items.</li> <li>Braided steel for superior strength and flexibility</li> <li>Protective vinyl coating helps prevent scratching</li> <li>Recommend for use with laminated locks, solid steel locks and mini-U-locks</li> </ul>			
	4	78DPF	460151
<b>6' Cable with Keyed Lock</b> <ul style="list-style-type: none"> <li>Keyed cable lock</li> <li>Integrated keyed locking mechanisms for strong pick resistance</li> <li>6' (1.8m) long x 3/8" (10mm) diameter flexible steel cable for strong cut resistance</li> <li>Protective vinyl coating helps prevent scratching</li> </ul>			
	4	8154DPF	460368



BUILDERS HARDWARE



730DPF

HASPS & HASPLOCKS

MASTER LOCK

Item	Pack	Part #	HDI #
<b>Hasp Straight Bar</b> <ul style="list-style-type: none"> <li>7-1/4" (18cm) long x 1-5/8" (41mm) wide heavy duty straight bar hasp</li> <li>Accepts shackle diameter up to 7/16" (11mm)</li> <li>Zinc plated hardened steel for maximum strength and weatherability</li> <li>Hardened steel staple resists cutting, sawing and hammering</li> <li>Hasp body conceals mounting hardware</li> <li>Mounting hardware included</li> <li>Ideal for utility vans, trailers, gang boxes, vending machines</li> </ul>	4	730DPF	460247



GUN LOCK

MASTER LOCK

Item	Pack	Part #	HDI #
<ul style="list-style-type: none"> <li>Keyed alike - one key opens all locks</li> <li>The world standard in trigger lock design</li> <li>Steel and zinc body for maximum durability</li> <li>4-pin tumbler cylinder helps prevent picking</li> <li>Special rubber pads protect gun's finish from marring or scratching</li> <li>Fits many handguns, rifles and shotguns</li> </ul>	6	90KAD-SPT	460155



BACK PACK & LUGGAGE LOCK

MASTER LOCK

Item	Pack	Part #	HDI #
<ul style="list-style-type: none"> <li>Black case with chrome thumbpiece</li> <li>Rugged metal construction</li> <li>3-wheel set-your-own combination locking for keyless convenience</li> </ul>	4	1547DCM	460363



SHOWCASE LOCK

NATIONAL

Item	Pack	Part #	HDI #
Adjustable lock for 1/4" sliding glass door. Disc tumbler. Adjustable 1 to 4". Polished nickel.	5	N183-798	455155



**HARDWARE DISTRIBUTORS, INC.**

**BUILDERS HARDWARE**

Page: G48

Date: 05/30/12





BUILDERS HARDWARE



**SOLID BRASS HINGE**  
NATIONAL V1810  
Hand polished - 5/8 x 2 3/4"

**2 per card**

Bright Brass 7XC  
(405005) N211-417  
Antique Brass  
(405006) N211-425  
pk 5



**SOLID BRASS HINGE**  
NATIONAL V1816  
Hand polished - 5/8 x 1"

**2 per card**

Bright Brass 18XC  
(405010) N211-441  
Antique Brass  
(405011) N211-458  
pk 5

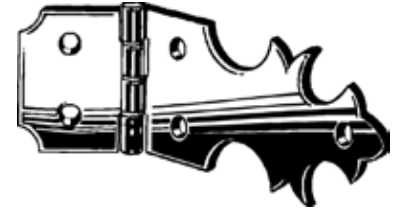

**SOLID BRASS HINGE**  
NATIONAL V1811  
Hand polished - 5/8 x 1 7/8"

**2 per card**

Bright Brass 22XC  
(405015) N211-433  
pk 5



**SOLID BRASS HINGE**  
NATIONAL V1814  
Hand polished - **2 per card**

**1 11/16 x 3 1/16"**

Bright Brass 75XC  
(405020) N211-847  
Antique Brass  
(405021) N211-854

**1 5/16" x 2 1/4"**

Bright Brass 76XC  
(405025) N211-821  
Antique Brass  
(405026) N211-839  
pk 5



**BRASS PLATED HINGE**  
NATIONAL V1812  
1 5/16 x 2 7/8"

**2 per card**

Bright Brass 077XC  
(405030) N211-805  
pk 5

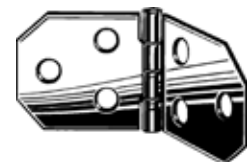

**SOLID BRASS HINGE**  
NATIONAL V1818  
Hand polished - 3/4 x 1 7/8"

**2 per card**

Bright Brass 93XC  
(405035) N211-862  
pk 5



**SOLID BRASS HINGE**  
NATIONAL V1813

**2 per card**  
Antique Brass  
1 1/8 x 1 1/8"  
(405031) N211-813  
pk 5



**CHEST HANDLES**  
NATIONAL V1864  
Brass plated - 1 3/8 x 3 1/2"

**2 per card**  
Bright Brass 0234XC  
(405040) N213-421  
pk 5

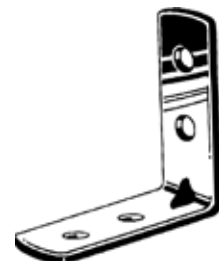

**SOLID BRASS BRACKETS**  
NATIONAL V1875  
4 per card

Bright Brass  
1/2 x 1" 401XC  
(405045) N213-389  
5/8 x 1 1/2" 4011/2XC  
(405050) N213-397  
pk 5



BUILDERS HARDWARE



**BRASS PLATED CORNERS**

NATIONAL V1854  
1 1/4 x 1 1/4"

4 per card

0476XC  
(405055) \_\_\_\_\_ N213-470  
pk 5

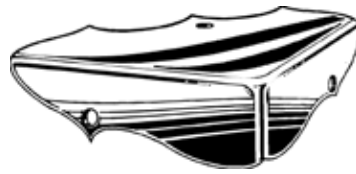

**SOLID BRASS CORNERS**  
NATIONAL V1851

4 per card

5/8 x 1 3/4"  
Bright Brass 479XC  
(405060) \_\_\_\_\_ N213-447

9/16 X 1 1/4"  
Bright Brass 480XC  
(405065) \_\_\_\_\_ N213-454  
Antique Brass  
(405061) \_\_\_\_\_ N213-462  
pk 5



**CHAIN DOOR GUARD**

NATIONAL V807  
Polished brass - 1 3/8 x 3 1/2"  
1 per card

Bright Brass 583XC  
(405075) \_\_\_\_\_ N183-590

Satin Chrome Finish  
(465446) \_\_\_\_\_ N274-407  
pk 5

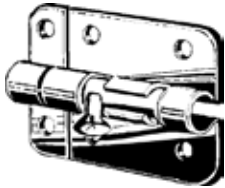

**BRASS DOOR BOLT**  
NATIONAL V1834

1 1/2 x 2"

1 per card

Bright Brass 766XC  
(405090) \_\_\_\_\_ N213-405  
pk 5



**SOLID BRASS HASP**  
NATIONAL V1824

Hand polished - 5/8 x 1 7/8"  
1 per card

Bright Brass 802XC  
(405100) \_\_\_\_\_ N211-466  
Antique Brass  
(405101) \_\_\_\_\_ N211-477  
pk 5



**SOLID BRASS HASP**  
NATIONAL V1826

Hand polished - 3/4 x 2 3/4"  
1 per card

0 804XC  
(405105) \_\_\_\_\_ N211-896  
Antique Brass  
(405102) \_\_\_\_\_ N211-904  
pk 5



**SOLID BRASS HASP W/HOOK**

NATIONAL V1828  
Hand polished - 3/4 x 2 3/4"  
1 per card

Bright Brass 840XC  
(405110) \_\_\_\_\_ N211-912  
Antique Brass  
(405107) \_\_\_\_\_ N211-920  
pk 5

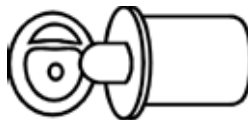

**BULLET CATCHES**  
NATIONAL V1845

Spring loaded friction catch.  
3/8" hole.

4 per card

Bright Brass  
(405128) \_\_\_\_\_ N219-055  
pk 5



**DECORATIVE CATCHES**  
NATIONAL V1846

1 3/8 x 7/8"

1 per card

Antique Brass  
(405129) \_\_\_\_\_ N211-961  
pk 5



BUILDERS HARDWARE

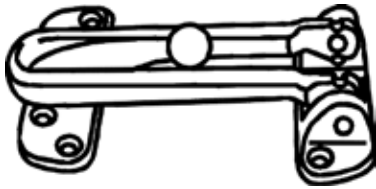

**DOOR SECURITY GUARD**

**NATIONAL V804**  
4 1/8 x 2 1/2"

**1 per card** with screws

Brass finish  
(405071) \_\_\_\_\_ N199-679

Satin Chrome finish  
(465444) \_\_\_\_\_ N273-649  
pk 5



**KEYED CHAIN DOOR LOCKS**

**NATIONAL V806**  
Opens from inside with or without key.

**1 per card** with screws

Brass finish  
(405072) \_\_\_\_\_ N183-582  
pk 5



**DOOR FLIP LOCKS NATIONAL V808**

Privacy door lock for interior or exterior doors.

**1 per card** with screws

Brass finish  
(405073) \_\_\_\_\_ N183-608  
pk 5

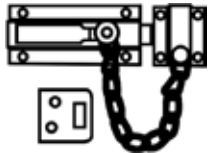

**DEADBOLT AND CHAIN GUARD**

**NATIONAL V837S**  
Combination deadbolt and chainguard.  
**1 per card** with screws

Brass finish  
(405074) \_\_\_\_\_ N199-703  
pk 5



**SELECT-A-LINK CHAIN DOOR FASTENERS**

**NATIONAL V838**  
Adjustable chain door guard.  
**1 per card** with screws

Brass finish  
(405076) \_\_\_\_\_ N152-181  
pk 5



**SLIDE BOLT NATIONAL V860**

Lightweight slide bolt - 3"  
Concealed plastic spring. Holds bolt in any position.

**1 per card** with screws

Brass finish  
(405077) \_\_\_\_\_ N152-850  
pk 5

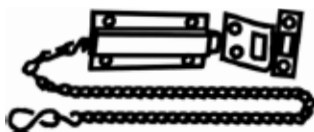

**CHAIN BOLT NATIONAL V862**

Lightweight chain bolt for doors, transom windows, etc.  
Chain release.

**1 per card** with screws

Brass finish  
(405078) \_\_\_\_\_ N155-762  
pk 2

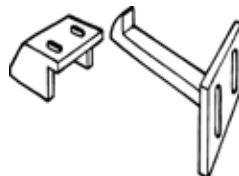

**CHILD SAFETY LOCK NATIONAL V824**

Child guard latch for most cabinets. White plastic.  
2 per card

(405079) \_\_\_\_\_ N183-749  
pk 5

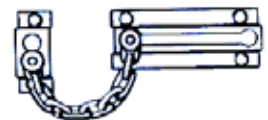

**CHAIN DOOR GUARD ULTRA**

Stamped steel w/harden steel chain

**1 per card**

(394202) \_\_\_\_\_ 29010-U  
pk 6



BUILDERS HARDWARE



**SOLID BRASS CATCHES**  
NATIONAL V1840

3/4 x 1 7/8"

2 per card

Bright Brass 865XC  
(405125) N211-946

Antique Brass  
(405126) N211-953  
pk 5



**HOOK AND STAPLES -  
SOLID BRASS**  
NATIONAL V1841

2 per card with screw

Bright Brass  
(405127) N211-938  
pk 5



**CABINET KNOBS  
W/POLISHED BRASS  
TOPS**

NATIONAL V1861

2 per card

1/2" 903XC  
(405140) N213-488

5/8" 904XC  
(405145) N213-496  
pk 5



**MINIATURE SOLID BRASS  
PADLOCK**  
NATIONAL V1880

1 per card

Antique Brass finish  
(405084) N213-520  
pk 5



**FLUSH RING PULL**  
NATIONAL V1870  
Solid Brass - 1 3/8"

1 per card

Bright Brass  
(405041) N219-063  
pk 5



**DECORATIVE KNOBS**  
NATIONAL V1862

2 per card

Antique Brass  
(405149) N213-504  
pk 5



**HANGER PLATE**  
NATIONAL V1873

Brass plated steel  
9/16 x 2" .040 gauge

4 per card

0706BP  
(405085) N213-413  
pk 5

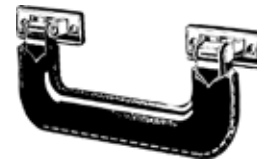

**PLASTIC HANDLE**  
NATIONAL V1863

Brown - 6" length

1 per card

1281XC  
(405160) N213-512  
pk 5



BUILDERS HARDWARE

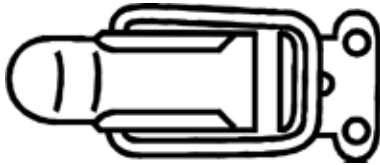

**DRAW CATCH**  
NATIONAL V1842  
3 1/16" length

2 per card

Bright Brass  
(405410) \_\_\_\_\_ N208-561  
pk 5

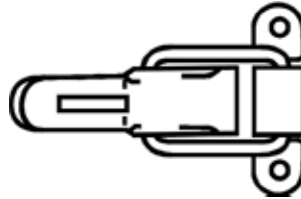

**LOCKABLE DRAW CATCH**  
NATIONAL V1843  
3 7/16" length

**2 per card**

Zinc  
(405411) \_\_\_\_\_ N208-579  
pk 5

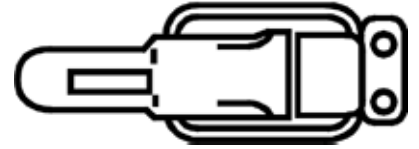

**LOCKABLE DRAW CATCH**  
NATIONAL V1844  
5" length

2 per card

Zinc  
(405412) \_\_\_\_\_ N208-587  
pk 5

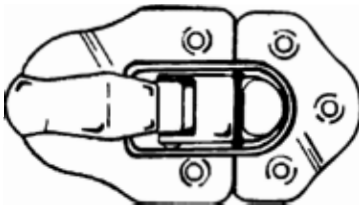

**DECORATIVE DRAW CATCH**  
NATIONAL V1848  
2 7/8" length

2 per card

Bright Brass  
(405413) \_\_\_\_\_ N208-595  
pk 5

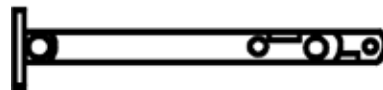

**FOLDING SUPPORTS - RIGHT**  
NATIONAL V1890R  
Support table legs, chest lids, etc.

**1 per card**

Bright Brass  
(405414) \_\_\_\_\_ N208-629  
pk 5

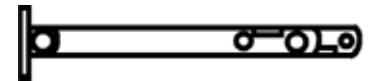

**FOLDING SUPPORTS - LEFT**  
NATIONAL V1890L  
Supports table legs, chest lids, etc.

**1 per card**

(405415) \_\_\_\_\_ N208-611  
pk 5



**CENTER LID SUPPORT**  
NATIONAL V1893C  
Allows smooth and easy opening of lids. Provides protection against slamming.

1 per card

Antique Brass 1088XC  
(405325) \_\_\_\_\_ N208-686  
pk 5



**LEFT LID SUPPORT**  
NATIONAL V1893L  
Allows smooth and easy opening of lids. Provides protection against slamming.

**1 per card**

Antique Brass L1089XC  
(405335) \_\_\_\_\_ N208-660  
pk 5

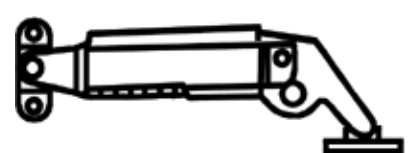

**RIGHT LID SUPPORT**  
NATIONAL V1893R  
Allows smooth and easy opening of lids. Provides protection against slamming.

**1 per card**

Antique Brass R1089XC  
(405330) \_\_\_\_\_ N208-678  
pk 5



BUILDERS HARDWARE



**FELT ADHESIVE PADS**  
NATIONAL V1719

Neutral  
16 per card  
7/8"

(405443) \_\_\_\_\_ N237-107

1 1/4"  
(405444) \_\_\_\_\_ N237-115

8 per card  
1 3/4"  
(405445) \_\_\_\_\_ N237-123

**2 per card**  
3 1/2 x 4"  
(405446) \_\_\_\_\_ N237-131  
pk 5



**FELT ADHESIVE PADS**  
NATIONAL V1716

Black  
**42 per card**  
3/8"

(405439) \_\_\_\_\_ N237-057

**24 per card**  
3/4"  
(405440) \_\_\_\_\_ N237-065

**3 per card**  
3 1/4 x 4"  
(405441) \_\_\_\_\_ N237-073  
pk 5



**FELT ADHESIVE PADS**  
NATIONAL V1717

Black  
**64 per card** Assorted Sizes

(405442) \_\_\_\_\_ N237-081  
pk 5



**FRICITION LID SUPPORTS**  
NATIONAL

Adjustable tension. Lid support.

1 per card V1891  
Bright Brass  
(405416) \_\_\_\_\_ N208-637

**LEFT**  
1 per card V1891L  
Bright Brass  
(405417) \_\_\_\_\_ N208-645

**RIGHT**  
1 per card V1892R  
Bright Brass  
(405418) \_\_\_\_\_ N208-652  
pk 5



BUILDERS HARDWARE

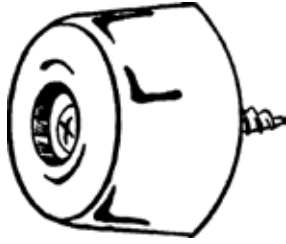

**SCREW ON BUMPERS**  
**NATIONAL V1700**

Designed for furniture, cabinets, sliding doors.

**4 per card** with screws

- 1/4 x 1/2" Brown  
(405428) \_\_\_\_\_ N225-342
  - 1/4 x 1/2" White  
(405429) \_\_\_\_\_ N225-359
  - 3/8 x 3/4" Brown  
(405430) \_\_\_\_\_ N225-367
  - 1/2 x 7/8" Brown  
(405431) \_\_\_\_\_ N225-375
  - 1/2 x 7/8" White  
(405432) \_\_\_\_\_ N225-383
- pk 5

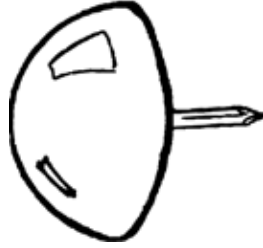

**TACK BUMPERS**  
**NATIONAL V1705**

Designed for furniture, cabinets, sliding doors.

**4 per card**

- 3/8" Black  
(405433) \_\_\_\_\_ N225-391
  - 3/4" Black  
(405434) \_\_\_\_\_ N225-409
  - 3/4" White  
(405435) \_\_\_\_\_ N225-417
- pk 5



**SELF ADHESIVE BUMPERS**

**NATIONAL V1708**

Designed for furniture, cabinets, sliding doors, etc.

**8 per card**

- 3/16 x 1/2" Brown  
(405051) \_\_\_\_\_ N225-425
- 3/16 x 1/2" White  
(405436) \_\_\_\_\_ N225-433

**4 per card**

- 5/16 x 3/4" Brown  
(405052) \_\_\_\_\_ N225-441
  - 5/16 x 3/4" White  
(405437) \_\_\_\_\_ N225-458
- pk 5



**SELF ADHESIVE BUMPER**  
**NATIONAL V1710**

Designed for furniture, cabinets, toy chests, etc.

**8 per card**

- Clear  
(405438) \_\_\_\_\_ N225-466
- pk 5



BUILDERS HARDWARE

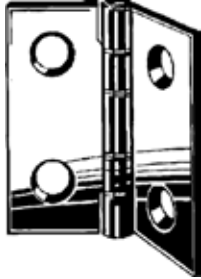

**SOLID BRASS NARROW BUTT HINGE**

**NATIONAL V1800**

Brass screws included

**4 per card**

3/4 x 5/8" 5075XC  
(405182) N211-193

1 x 3/4" 5100XC  
(405185) N211-177

**2 per card**

1 1/2 x 7/8" 5150XC  
(405190) N211-219

2 x 1" 5200XC  
(405195) N211-235

2 1/2 x 1 1/8" (405188) N211-250

Antique Brass Finish

2 per card

3/4 x 5/8" (405183) N211-201

1 x 3/4" (405180) N211-185

1 1/2 x 7/8" (405184) N211-227

2 x 1" (405186) N211-243

2 1/2 x 1 1/8" (405187) N211-268

pk 5

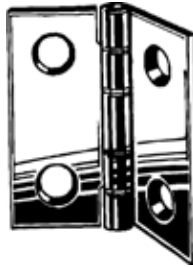

**SOLID BRASS MIDDLE BUTT HINGE**

**NATIONAL V1801**

Brass screws included

4 per card

3/4 x 11/16" 6075XC  
(405200) N211-276

1 x 13/16" 6100XC  
(405205) N211-284

**2 per card**

1 1/2 x 1" 6150XC  
(405210) N211-292

2 x 1 13/16" 6200XC  
(405215) N211-300

2 1/2 x 1 9/16" 6250XC  
(405220) N221-318

pk 5

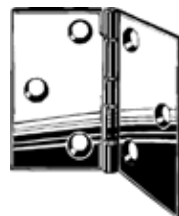

**SOLID BRASS DESK BUTT HINGE**

**NATIONAL V1805**

Brass screws included

**2 per card**

1 1/2 x 2" 8150XC  
(405245) N211-870

2 x 3 1/16" 8200XC  
(405250) N211-888

pk 5

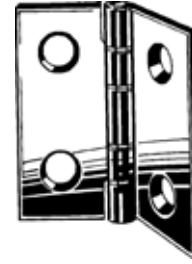

**SOLID BRASS BROAD BUTT HINGE**

**NATIONAL V1802**

Brass screws included

4 per card

3/4 x 1" 7075XC  
(405225) N211-326

1 x 1" 7100XC  
(405230) N211-334

**2 per card**

1 1/2 x 1 1/4" 7150XC  
(405235) N211-359

2 x 1 3/8" 7200XC  
(405240) N211-375

2 1/2 x 1 3/4" (405239) N211-391

Antique Brass Finish

**2 per card**

1 x 1" (405231) N211-342

1 1/2 x 1 1/4" (405236) N211-367

2 x 1 3/8" (405237) N211-383

2 1/2 x 1 3/4" (405238) N211-409

pk 5





BUILDERS HARDWARE



**BALL TIP HINGES**

NATIONAL V1806

Solid Brass

**2 per card**

Antique Brass Finish

1 1/2 x 7/8"

(405251) \_\_\_\_\_ N213-546

1 1/2 x 1 1/4"

(405252) \_\_\_\_\_ N213-538

2 x 1 3/8"

(405254) \_\_\_\_\_ N213-553

pk 5



BUILDERS HARDWARE



**PULL SASH LIFT**

**IVES**

For double hung windows and other general utility applications.

**1 per poly bag** w/screws

Satin Brass Aluminum

(485035) SP-026A3

pk 25



**SASH LIFT**

**NATIONAL V-135**

Traditional lift for double hung and sliding windows.

**2 per card** with screws.

Brass finish

(485031) N115-691

pk 5



**PULL SASH LIFT**

**NATIONAL V-170**

4" bar type sash lift for windows, etc.

**1 per card** with screws.

Brass finish

(485032) N116-558

Nickel finish

(485033) N116-616

Antique Brass

(485034) N116-848

White finish

(465421) N248-484

Satin Chrome finish

(465431) N274-316

pk 5



BUILDERS HARDWARE

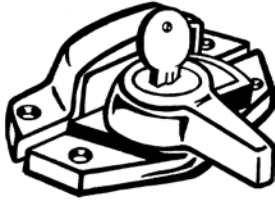

VKA821  
**KEYED SASH LOCKS  
NATIONAL**

Keyed sash lock for double hung windows and other cabinets.  
1 per card with screws.

Brass Finish  
(485040) N183-723  
pk 5

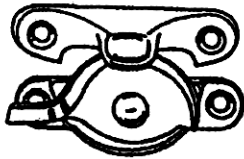

**SASH LOCK**

Zinc die cast metal.  
1 per poly bag w/screws  
Ives

Antique Brass Aluminum  
(485030) SP-07-A5  
pk 25

Antique Nickel (Pewter)  
(485023) SP-07-MB15A  
pk 20



**SASH LOCK  
NATIONAL - TIGHT SEAL**  
Spring action.  
Pulls sashes together for a tight seal.

1 per card with screws.  
Brass finish V602  
(485039) N193-607  
White finish  
(465426) N248-476  
pk 5



V600  
**TRADITIONAL SASH  
LOCK  
NATIONAL**

Zinc die cast metal  
1 per card with screws.  
Brass Finish  
(485036) N148-684  
pk 8

Nickel Finish  
(485025) N148-767  
White finish  
(465425) N248-468  
Chrome finish  
(465432) N273-458  
pk 5



V601  
**CONTEMPORARY SASH  
LOCK  
NATIONAL**

Zinc die cast metal  
One per card with screws.  
Brass Finish  
(485037) N170-779

Antique Brass  
(485038) N170-761  
pk 5



BUILDERS HARDWARE



**HAND RAIL BRACKET**

**NATIONAL V112**

3" overall projection for supporting handrails.

**1 per card** with screws

Brass Finish  
(465548) \_\_\_\_\_ N112-888

Antique Brass  
(465549) \_\_\_\_\_ N159-566

White Finish  
(465417) \_\_\_\_\_ N248-351

Satin Chrome Finish  
(465438) \_\_\_\_\_ N274-258

Oil Rub Bronze  
(465900) \_\_\_\_\_ N330-738

Pewter  
(465901) \_\_\_\_\_ N325-530

Satin Nickel  
(465902) \_\_\_\_\_ N325-548

pk 5



**HAND RAIL BRACKET**

For supporting wood handrails at any required angle of stairway.

**1 per poly bag** with screws

**NATIONAL**

Satin Brass - (Alum) SP059-A3  
(485290) \_\_\_\_\_ N178-871  
pk 75

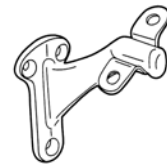

**DON-JO**

Cast aluminum. 1 per poly bag.

Satin Brass  
(427004) \_\_\_\_\_ 130-605

Antique Brass  
(427109) \_\_\_\_\_ 130-609

Satin Nickel  
(427005) \_\_\_\_\_ 130-619

Antique Pewter  
(427010) \_\_\_\_\_ 130-620

Oil Rubbed Bronze  
(427015) \_\_\_\_\_ 130-613

Bright Chrome  
(485291) \_\_\_\_\_ 130-625

Satin Chrome  
(427006) \_\_\_\_\_ 130-626

pk 20



BUILDERS HARDWARE

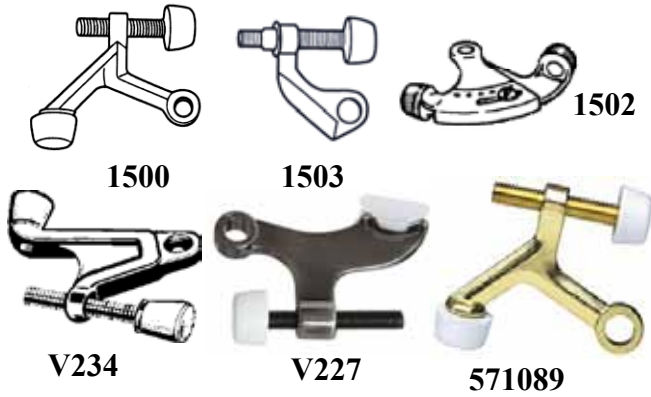

HINGE PIN DOOR STOPS

DON-JO

Item	Pack	Part #	HDI #
<b>Cast Zinc. 1 Per Poly Bag.</b>			
Satin Brass	100	1500-605	427044
Satin Nickel	100	1500-619	427045
Antique Pewter	100	1500-620	427050
Bright Chrome	100	1500-625	427041
<b>Cast Brass</b>			
Satin Brass	10	1503-605	427055
Satin Nickel	10	1503-619	427065
Antique Brass	10	1503-609	427080
<b>Steel - Adjustable</b>			
Satin Nickel	20	1502-619	427120
Satin Chrome	20	1502-626	427122

NATIONAL

Item	Pack	Part #	HDI #
<b>V234</b> - Adjustable, prevents wall damage. 1 per card.			
Bright Brass	5	N154-526	465539
Antique Brass	5	N157-046	465540
White Finish	5	N248-401	485277
Satin Chrome Finish	5	N274-084	465440
<b>V227</b> - Designed for hollow core doors; Easily adjustable by turning adjusting screw. 1 per card.			
Oil Rub Bronze	5	N331-124	465909
Pewter	5	N325-571	465910
Satin Nickel	5	N325-589	465911

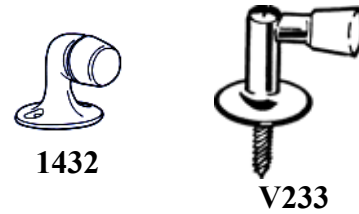

FLOOR DOOR STOPS

DON-JO

Item	Pack	Part #	HDI #
1 1/4" Base, 1 5/16" High			
Oil Rubbed Bronze	10	1432-613	427072
Satin Nickel	10	1432-619	427073

NATIONAL

Item	Pack	Part #	HDI #
<b>V233</b> - 1 1/4" High. 1 per card.			
Bright Brass	5	N154-500	465538



BUILDERS HARDWARE

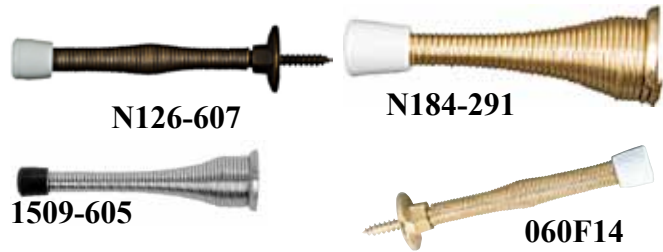

**SPRING DOOR STOPS**

**NATIONAL**

Item	Pack	Part #	HDI #
<b>V230</b> - 3" length. One piece construction. 2 per card.			
Bright Brass	5	N126-607	465533
Antique Brass	5	N159-020	465534
Satin Chrome Finish	5	N273-680	465449
Chrome Finish	5	N273-672	485281
<b>V232</b> - 3" projection. Detachable base for easy installation. 2 per card.			
Bright Brass	5	N184-291	465537
Oil Rub Bronze	5	N331-132	465912
Pewter	5	N326-009	465913
Satin Nickel	5	N331-140	465914
White	5	N265-256	465915

**DON JO**

Item	Pack	Part #	HDI #
1 per poly bag.			
<b>3-1/8" Projection</b>			
Satin Brass	50	1509-605	427033
Antique Brass	50	1509-609	427034
Satin Nickel	50	1509-619	427035
Antique Pewter	50	1509-620	427040
Bright Chrome	50	1509-625	427101
<b>3-3/4" Projection</b>			
Brass	50	1510-605	427039
Antique Brass	50	1510-609	427036
Satin Nickel	50	1510-619	427037
Bright Chrome	50	1510-625	427102

**IVES**

Item	Pack	Part #	HDI #
3" projection. Flexible for safety and easy cleaning. Die cast design will not deform.			
Bright Nickel (Chrome)	20	060F14	485296



BUILDERS HARDWARE

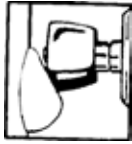

**"SOFSTOP" DOOR STOPS**

**NATIONAL V337**

Soft plastic cushion type shock-absorbing door stop. Self adhesive.

**2 per card**

White  
(465578) N213-561

Brown  
(465579) N213-587

Almond  
(465581) N213-579  
pk 5



**WALL DOOR STOPS**

**NATIONAL V1932**

1 7/8" diameter.  
1 1/8" projection.  
**1 per card with screws**

Satin Chrome Finish  
(405420) N215-863  
pk 5



**"SOFSTOP" COVER-UP DOOR STOP**

**NATIONAL V336**

Cushion style door stop to cover up previous wall damage. Self adhesive.

**1 per card**

Almond  
(465577) N213-595

White  
(465430) N246-041  
pk 2



**WALL DOOR STOPS**

**NATIONAL V1935**

2 5/16" diameter.  
1 1/8" projection.  
**1 per card with screws**

Satin Chrome Finish  
(405421) N215-848

Bright Brass US3 CD80-4010  
(465935) N198-069  
pk 5



**FLOOR DOOR STOPS**

**NATIONAL V1940**

High dome style. 1 11/16" high.  
**1 per card with screws**

Satin Chrome Finish  
(405423) N215-814  
pk 5



**FLOOR DOOR STOP**

**NATIONAL V1936**

Low dome style. 1 1/8" high.

**1 per card with screws**

Satin Chrome Finish  
(405422) N215-830

Bright Brass  
(465544) N198-077  
pk 5



**WALL BUMPER DOOR STOPS**

**DON-JO**

2 1/2"

Brass  
(427063) 1407-605

Satin Nickel  
(427064) 1407-619

Satin Chrome  
(427067) 1407-626  
pk 10

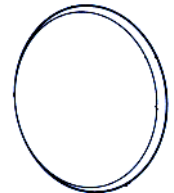

**DOOR KNOB PROTECTORS**

**ULTRA**

Protects walls from door knobs. Self stick adhesive foam back, white finish, can be painted.

Bulk  
3" Round

(394203) 57701-U  
pk 100



BUILDERS HARDWARE



**KICKDOWN DOOR STOP**  
NATIONAL V238/239

Rubber foot with spring design holds holder in up position.

**1 per card**

**4"**

Bright Brass

(390643) N184-259

Chrome

(465543) N184-275

White

(465424) N248-435

Satin Chrome Finish

(465443) N273-532

**5"**

#239 Chrome Finish (Heavy)

(465450) N184-234

#239 Satin Chrome (Heavy)

(465442) N273-557

pk 5



**REPLACEMENT TIP**  
NATIONAL V238TS

Rubber tip fits National V238 door stop.

**2 per card**

(465334) N225-557

pk 5



**SOLID BRASS KICKDOWN DOOR STOP**

NATIONAL V1938

5" rubber tipped.

**1 per card**

Polished Brass

(465545) N198-085

pk 5

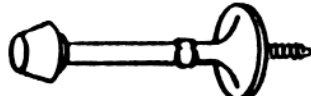

**RIGID DOOR STOP**  
IVES

3" projection.

**1 per poly pack**

Antique Brass - Aluminum

(485261) SP-61-A5

pk 25

Antique Nickel (Pewter) - Brass

(428410) SP-61-MB15A

Oil Rubbed Bronze - Brass

(428441) 61MB-10B

pk 10



**RIGID DOOR STOP**  
DON-JO

3" projection. 1 per poly bag.  
Cast Aluminum

Satin Brass

(427009) 1504-605

Satin Nickel

(427025) 1504-619

Antique Pewter

(427030) 1504-620

Oil Rubbed Bronze

(427020) 1504-613

Satin Chrome

(427031) 1504-626

pk 50

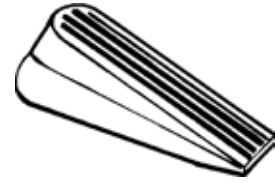

**RUBBER DOOR WEDGE**  
NATIONAL V334/V335

Wedge style door stop - brown.

**2 per card**

**4"**

(085110) 9132  
N225-987

**5"**

(465576) N213-603

pk 5





BUILDERS HARDWARE

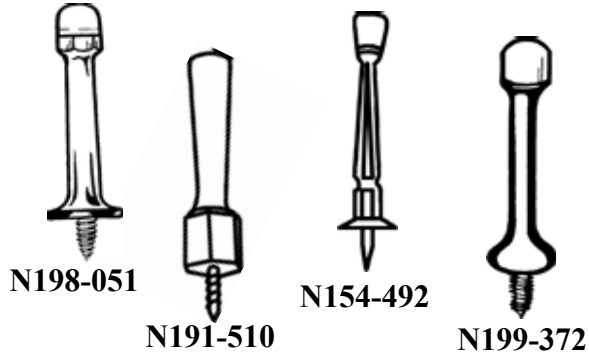

**RIGID DOOR STOPS**

NATIONAL

Item	Pack	Part #	HDI #
<b>Solid Brass V1931</b> - Slotted tip design for easy installation. Use on wall at base of door to prevent damage from door knob. 1 per card.			
Bright Brass US3	5	N198-051	465940
<b>Soft Jamb V235</b> - 3/4" projection. One piece flexible design. 2 per card.			
White	5	N191-510	465541
<b>Rigid V231</b> - 3" projection. 2 per card.			
Bright Brass	5	N154-492	465536
<b>Heavy Duty Rigid V236</b> - 3" projection. Heavy duty design. 2 per card			
Bright Brass	10	N199-372	465542



BUILDERS HARDWARE



**WARDROBE HOOK  
NATIONAL V1962**

Solid Brass. 3 5/8" projection-upper. Contemporary design for use in bedrooms, bathrooms, closets, and foyers. 1 per card with screws.

Polished Brass 80-4035  
(465960) N198-135  
pk 5



**DOUBLE HOOK  
NATIONAL V1963**

Solid Brass. 1" projection. Complements finest interior decors. Use in foyers and reception areas. 1 per card with screws

Polished Brass 80-4030  
(465955) N198-127  
pk 5



**HEAVY COAT & HAT  
HOOK (WARDROBE)  
NATIONAL V164**

Cast zinc alloy. Built to handle heavy outerwear. 5" projection. 1 per card with screws

Brass Finish 81-9179  
(485015) N199-265  
White Finish  
(465420) N248-393  
pk 5



**DOUBLE CLOTHES HOOK  
NATIONAL V163**

1 1/2" projection. Cast zinc. 2 per card

Brass Finish  
(465558) N199-224  
Nickel Finish  
(465557) N199-232  
White Finish  
(465419) N248-385  
Satin Chrome Finish  
(465437) N274-217  
Oil Rub Bronze  
(465906) N330-829  
Pewter  
(465907) N325-514  
Satin Nickel  
(465908) N325-522  
pk 5

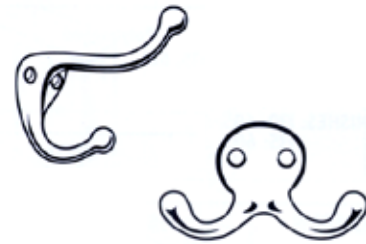

**COAT & HAT HOOKS  
DON-JO**

**Single**  
Brass  
(427013) 300-605  
Oil Rub Bronze  
(427014) 300-613  
Satin Nickel  
(427007) 300-619  
Antique Nickel  
(427016) 300-620  
Satin Chrome  
(427110) 300-626  
pk 20

**Double**  
Oil Rub Bronze  
(427018) 302-613  
Satin Nickel  
(427019) 302-619  
Brass  
(427017) 302-605  
pk 20



BUILDERS HARDWARE



**COAT & HAT HOOK  
NATIONAL V1960**

Solid brass. 2-7/8" projection upper.  
1-21/32" projection - lower. Use in  
bedrooms,  
bathrooms, closet and foyers.

**Polished Brass** 80-4020  
(465945) N198-101  
pk 5



**ECONOMY COAT & HAT  
HOOK**

**NATIONAL MPB160**  
Aluminum Cast - poly bag

**2 per Poly Bag  
Brass**  
(485005) N243-717  
pk 10

**Ives - 1 per Poly Bag**  
Antique Brass  
(485007) SP-571-A5  
Antique Nickel (Pewter)  
(428416) SP-571-CB-15A  
pk 25

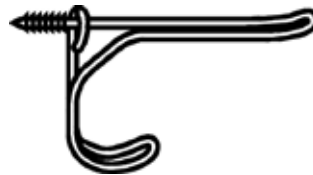

**WIRE COAT & HAT HOOK  
NATIONAL V161**

One piece wire that easily screws into  
a wall.  
**2 per pack**

Zinc  
(485012) N234-757  
pk 20

Brass  
(485011) N243-725

Bright Brass  
(465554) N186-866  
pk 5



**COAT & HAT HOOKS  
NATIONAL V160**

Zinc die cast  
**2 per card**

Brass Finish  
(465552) N154-575  
Nickel Finish  
(465553) N192-781  
White Finish  
(485006) N248-369  
Satin Chrome Finish  
(465434) N274-134  
Oil Rub Bronze  
(465903) N330-761  
Pewter  
(465904) N325-472  
Satin Nickel  
(465905) N325-480  
pk 5



BUILDERS HARDWARE



**SINGLE ROBE HOOK**  
**NATIONAL V1962**

Solid Brass. 1-9/16" hook projection.  
For use where a single hook or a series  
of single hooks is desired.  
1 per card w/screws

Polished Brass                    80-4025  
(465946)                            N198-119  
pk 5



**SINGLE CLOTHES HOOK**  
**NATIONAL V162**

1-9/16" projection. Cast zinc.  
2 per card

Brass Finish  
(465556)                            N199-182  
Nickel Finish  
(465555)                            N199-190  
White Finish  
(465418)                            N248-377  
Satin Chrome Finish  
(465433)                            N274-175  
pk 5



**HEAVY DUTY**  
**GARMENT HOOKS**  
**NATIONAL V167**

1 per card

Brass Finish  
(465415)                            N248-245  
Nickel Finish  
(465416)                            N248-252  
Satin Chrome Finish  
(465436)                            N273-508  
pk 5



**UNDERSHELF COAT**  
**HOOKS**

**NATIONAL V165**  
For use undershelves.  
2 per card with screws

White Finish  
(465410)                            N245-852  
Brass Finish  
(465411)                            N245-811  
Nickel Finish  
(465412)                            N245-837  
pk 5



**HEAVY DUTY COAT &**  
**HAT HOOKS**

**NATIONAL V166**  
1 per card with screws.

Brass Finish  
(465413)                            N248-229  
Nickel Finish  
(465414)                            N248-237  
Satin Chrome Finish  
(465435)                            N273-524  
pk 5



**GARMENT HOOKS**  
**NATIONAL V2707**

FasTac™ plastic adhesive hook. White  
finish. 1 per card

Large  
(840240)                            N308-213  
pk 3



BUILDERS HARDWARE



41433                      41615                      41519



41605                      41521                      41535

**BRASS FINISH CABINET KNOBS  
ULTRA**

Item	Pack	Part #	HDI #
1 1/4" Polished Brass Finish High Density Zinc w/Porcelain	25	41433	391009
1 1/4" Polished Brass Finish High Density Zinc w/Plastic	25	41615	394022
1" Polished Brass Finish High Density Zinc	25	41519	394018
1 3/4" Polished Brass Finish High Density Zinc	50	41605	394021
1 1/4" Polished Brass Finish High Density Zinc	25	41521	394019
1 1/4" Polished Brass Finish High Density Zinc	25	41535	394101



41497                      41510

**BRASS FINISH CABINET KNOBS  
ULTRA**

Item	Pack	Part #	HDI #
1" Polished Brass Finish High Density Zinc	25	41519	394018
1 3/4" Polished Brass Finish High Density Zinc	50	41605	394021
1 1/4" Polished Brass Finish High Density Zinc	25	41521	394019
1 7/16" Polished Brass Finish - High Density Zinc	25	41625	394027
1 1/4" Polished Brass Finish High Density Zinc	25	41535	394101
1 1/4" Polished Brass/ Clear Finish Acrylic w/High Density Zinc	25	41497	394099
1 1/4" Polished Brass Finish Solid Brass	25	41510	394049



BUILDERS HARDWARE



41618



41610



41655



41660



41708



41752



41509



41709



41545

ANTIQUÉ FINISH CABINET KNOBS

ULTRA

Item	Pack	Part #	HDI #
1 1/4" Antique English Finish High Density Zinc w/Ceramic	25	41618	394024
1 1/2" Antique Brass Finish High Density Zinc	25	41610	394112
1 3/8" Antique Brass Finish High Density Zinc	25	41655	394029
1 1/4" Antique Brass Finish Hollow Steel	25	41660	394030
1 5/16" Antique Brass Finish High Density Zinc	25	41708	394118
1 1/4" Polished Antique Copper Finish - High Density Zinc	25	41752	394127
1 1/8" Polished Antique Copper Finish - High Density Zinc	25	41509	394100
1 5/16" Antique Steel Finish High Density Zinc	25	41709	394119
1 5/32" Polished Antique Copper Finish - Solid Brass	25	41545	394052



41446



41447



41448



41457



41458

WOODEN CABINET KNOBS

ULTRA

Item	Pack	Part #	HDI #
1 1/2" Unfinished Beech	25	41446	391010
1 3/4" Unfinished Beech	25	41447	394011
2" Unfinished Beech	25	41448	394012
1 1/4" Unfinished Beech	25	41457	394016
1 1/2" Unfinished Beech	25	41458	394017



41427

PORCELAIN / CERAMIC CABINET KNOBS

ULTRA

Item	Pack	Part #	HDI #
1 1/2" Black Porcelain	25	41427	394008



WHITE CABINET KNOBS

ULTRA

Item	Pack	Part #	HDI #
1 1/4" White Finish Solid Zinc	25	41835	394182



BUILDERS HARDWARE



41536

STEEL CABINET KNOBS

ULTRA

Item	Pack	Part #	HDI #
1 1/8" Black Hammered	25	41536	394102



41583

41911

OIL RUBBED BRONZE CABINET KNOBS

ULTRA

Item	Pack	Part #	HDI #
1 1/8" Oil Rubbed Bronze Finish - Solid Brass	12	41583	394105
1 1/4" Oil Rubbed Bronze Finish - Solid Brass	25	41911	394178



41591

41649

41543



41737

41661

41906

NICKEL FINISH CABINET KNOBS

ULTRA

Item	Pack	Part #	HDI #
1 1/8" Black Nickel Finish High Density Zinc	25	41591	394108
1 1/4" Satin Nickel Finish High Density Zinc	25	41779	394133
1 1/8" Satin Nickel Finish Solid Brass	12	41649	394113
1 1/4" Satin Nickel Finish Solid Brass	25	41543	394050
1 1/4" Satin Nickel Finish Solid Brass	12	41737	394159
1 1/4" Satin Nickel Finish Solid Brass	12	41661	394064
1 1/4" Satin Nickel Finish Solid Brass	25	41906	394156



BUILDERS HARDWARE



41778



41598



41616



41553



41570



41905

CHROME FINISH CABINET KNOBS

ULTRA

Item	Pack	Part #	HDI #
1¼" Satin Chrome Finish High Density Zinc	25	41778	394132
1¼" Polished Chrome Finish High Density Zinc	25	41598	394020
1¼" Polished Chrome Finish High Density Zinc w/Plastic	25	41616	394023
1¼" Polished Chrome Finish Solid Brass	25	41553	394058
1¼" Polished Chrome Finish Solid Brass	25	41570	394060
1¼" Satin Chrome Finish Solid Brass	25	41905	394065



41744



41745



41747



41748

RESIN CABINET KNOBS

ULTRA

Item	Pack	Part #	HDI #
1¼" Rose Knob	25	41744	394121
1¼" Baseball Knob	25	41745	394122
1¼" Football Knob	25	41747	394124
1¼" Basketball Knob	25	41748	394125





BUILDERS HARDWARE



BRASS FINISH CABINET PULLS

BRASS FINISH CABINET PULLS

ULTRA

ULTRA

Item	Pack	Part #	HDI #
3" Polished Brass Finish Zinc Die Cast	25	59145	394032
3" Polished Brass Finish Zinc Die Cast	25	59551	394145
3" Polished Brass Finish Zinc Die Cast w/White Porcelain	25	59636	394151

Item	Pack	Part #	HDI #
3" Polished Brass Finish Solid Brass	25	59100	394134
3½" Polished Brass Finish Solid Brass	25	59105	394066
3½" Polished Brass Finish Zinc Die Cast	25	59543	394074



BUILDERS HARDWARE



59537 59542 59621 59525



59565 59213

ANTIQUÉ FINISH CABINET PULLS

ULTRA

Item	Pack	Part #	HDI #
3" Antique Brass Finish Zinc Die Cast	25	59537	394036
3" Antique Brass Finish Zinc Die Cast	25	59542	394037
3" Antique Brass Finish Zinc Die Cast	25	59621	394040
3" Antique Brass Finish Zinc Die Cast	25	59525	394143
3" Antique Brass Finish Zinc Die Cast	25	59565	394038
3" Antique Steel Finish Zinc Die Cast	25	59213	394138



59464 59600 59613 59219



59599 59575 59615 59188

NICKEL FINISH CABINET PULLS

ULTRA

Item	Pack	Part #	HDI #
3" Brushed Nickel Finish Zinc Die Cast	25	59464	394141
3" Satin Nickel Finish Zinc Die Cast	25	59600	394149
3" Satin Nickel Finish Zinc Die Cast	25	59613	394080
3" Satin Nickel Finish Solid Brass	10	59219	394139
3" Satin Nickel Finish Zinc Die Cast	25	59599	394157
3½" Satin Nickel Finish Zinc Die Cast	25	59575	394076
3½" Satin Nickel Finish Zinc Die Cast	25	59615	394081
3" Black Nickel Finish Solid Brass	25	59188	394070



BUILDERS HARDWARE



59651

WOODEN CABINET PULLS

ULTRA

Item	Pack	Part #	HDI #
3" Unfinished Oak	25	59651	394042



59688

PEWTER CABINET PULLS

ULTRA

Item	Pack	Part #	HDI #
3 1/2" Pewter Finish Zinc Die Cast	25	59688	394154



59485

PLASTIC CABINET PULLS

ULTRA

Item	Pack	Part #	HDI #
4" White Plastic	50	59485	394035



59626

OIL RUBBED BRONZE CABINET PULLS

ULTRA

Item	Pack	Part #	HDI #
3" Oil Rubbed Bronze Finish Zinc Die Cast	25	59626	394158



59221

STEEL CABINET PULLS

ULTRA

Item	Pack	Part #	HDI #
3 1/4" Black Steel	25	59221	394140



BUILDERS HARDWARE



**CHROME FINISH CABINET PULLS**

ULTRA

Item	Pack	Part #	HDI #
3" Polished Chrome Finish Steel	25	59115	394067
3" Polished Chrome Finish Solid Brass	25	59596	394079
3" Polished Chrome Finish Zinc Die Cast	25	59150	394033
3½" Satin Chrome Finish Steel	25	59135	394135
4" Satin Chrome Finish Steel	25	59140	394136



BUILDERS HARDWARE



**POLISHED BRASS  
SELF-CLOSING HINGE**  
ULTRA HARDWARE  
3/8" Inset

(394090) 34915  
pk 50



**POLISHED CHROME  
SELF-CLOSING HINGE**  
ULTRA HARDWARE  
3/8" Inset

(394093) 34921  
pk 50



**OIL RUBBED BRONZE  
SELF-CLOSING HINGE**  
ULTRA HARDWARE  
3/8" Inset

(394174) 34908  
pk 50



**WHITE SELF-CLOSING  
HINGE**  
Ultra Hardware  
3/8" Inset

(394091) 34918  
pk 50



**ANTIQUE BRASS  
SELF-CLOSING HINGE**  
ULTRA HARDWARE  
3/8" Inset

(394087) 34905  
pk 50



**SATIN NICKEL  
SELF-CLOSING HINGE**  
ULTRA HARDWARE  
3/8" Inset

(394171) 34906  
pk 50



BUILDERS HARDWARE



**POLISHED BRASS  
SELF-CLOSING HINGE**  
ULTRA HARDWARE  
Flush

(394088) 34910  
pk 50



**WHITE SELF-CLOSING  
HINGE**  
ULTRA HARDWARE  
Flush

(394089) 34912  
pk 50

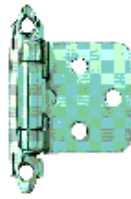

**POLISHED CHROME  
SELF-CLOSING HINGE**  
ULTRA HARDWARE  
Flush

(394092) 34920  
pk 50



**NICKEL PLATED  
CONCEALED HINGE**  
ULTRA HARDWARE

105° full overlay  
(394085) 34880  
105° half overlay  
(394179) 34875  
pk 10

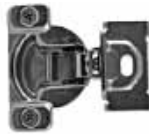

**EURO HINGE**  
ULTRA HARDWARE  
Hinge cup; Furnished w/premouted  
doweled screws.

(394181) 34850  
pk 10



**ANTIQUE BRASS  
SELF-CLOSING HINGE**  
ULTRA HARDWARE  
Flush

(394086) 34900  
pk 50



**OIL RUBBED BRONZE  
SELF-CLOSING HINGE**  
ULTRA HARDWARE  
Flush

(394177) 34901  
pk 50



**SATIN NICKEL  
SELF-CLOSING HINGE**  
ULTRA HARDWARE  
Flush

(394172) 34904  
pk 50



**NICKEL PLATED  
CONCEALED HINGE**  
ULTRA HARDWARE

170° full overlay  
(394170) 34865  
pk 10



BUILDERS HARDWARE



**BROWN MAGNETIC CATCH**

ULTRA HARDWARE  
2 3/8" x 5/8"

(394001) 13504  
pk 50



**BROWN MAGNETIC CATCH**

Ultra Hardware  
1 3/4" x 1/2"

(394160) 13500  
pk 50



**ZINC PLATED DOUBLE ROLLER CATCH**  
ULTRA HARDWARE

(394162) 13505  
pk 100



**WHITE MAGNETIC CATCH**  
ULTRA HARDWARE

1 3/4" x 1/2"  
(394161) 13502  
pk 50

2 per pack  
2 3/8 x 3/8"  
(394180) 13494  
pk 25



**BLACK MAGNETIC LATCH**  
ULTRA HARDWARE  
Square

(394003) 13615  
pk 50



**BALL CATCH**  
NATIONAL V716  
1" x 2-1/8"  
1 per card

Chrome Finish  
(465439) N273-474  
pk 5

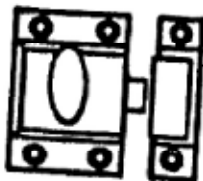

**CUPBOARD CATCH**  
NATIONAL V699

Turn type. Positive action keeps cabinet door securely closed. With fasteners.

**Brass** CD6429  
(485250) N149-625  
pk 5



**BALL LATCHES**  
DON-JO

Adjustable with wide and narrow strike - 2 1/8" x 1"

**Satin Nickel**  
(427057) 1712-619  
**Antique Pewter**  
(427106) 1712-620  
pk 20



**DRAWER SLIDE  
KNAPE & VOGT**

Medium duty for general applications.  
3/4 extension under drawer mounting.  
High density polypropylene rollers.  
Zinc coated steel. Mounts with staples  
or screws.  
1 set per poly bag.

50# class

22-5/8"

(455175)

1175PZC

pk 10





BUILDERS HARDWARE



**1 1/2" CONTINUOUS HINGE NATIONAL**

1/2" joints  
Screw holes on 2" centers  
1 per poly bag - fasteners included

**Bright Nickel**

12"	
<u>(405253)</u>	<u>N265-389</u>
30"	O1303NP-30
<u>(405300)</u>	<u>N148-171</u>
48"	O1303NP-48
<u>(405305)</u>	<u>N148-320</u>
72"	O1303NP-72
<u>(405310)</u>	<u>N148-486</u>
pk 1	

**Bright Brass**

12"	
<u>(405248)</u>	<u>N265-363</u>
30"	O1303BP-30
<u>(405285)</u>	<u>N148-155</u>
48"	O1303BP-48
<u>(405290)</u>	<u>N148-304</u>
72"	O1303BP-72
<u>(405295)</u>	<u>N148-460</u>
pk 1	



**1-1/16" CONTINUOUS HINGE NATIONAL**

1/2" screw joints  
Screw holes on 2" centers  
1 per poly bag - fasteners included

**Bright Nickel**

12"	
<u>(405247)</u>	<u>N265-371</u>
30"	O1301NP-30
<u>(405270)</u>	<u>N148-221</u>
48"	O1301NP-48
<u>(405275)</u>	<u>N148-379</u>
72"	O1301NP-72
<u>(405280)</u>	<u>N148-536</u>
pk 1	

**Bright Brass**

12"	
<u>(405249)</u>	<u>N265-355</u>
30"	O1301BP-30
<u>(405255)</u>	<u>N148-205</u>
48"	O1301BP-48
<u>(405260)</u>	<u>N148-353</u>
72"	O1301BP-72
<u>(405265)</u>	<u>N148-510</u>
pk 1	



BUILDERS HARDWARE

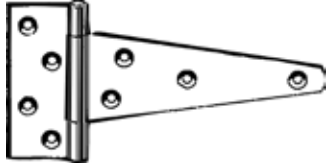

**HEAVY DUTY TEE HINGE**

Bulk Pack. For all types of exterior work on barn doors, large gates, etc. Fasteners not included. Zinc plated. US2C

sold / price each hinge

National 286BC

4"	14-5600
(465066)	N129-023
5"	14-4920
(465068)	N129-072
6"	14-5020
(465070)	N129-171
pk 10	
8"	14-5160
(465072)	N129-221
10"	14-5252
(465074)	N128-900
12"	14-5355
(465076)	N128-959
pk 5	

**Ultra Hardware**

4"	06284
(425205)	60812-U
5"	6908-5
(425210)	60813-U
6"	06286
(425215)	60814-U
8"	6908-8
(425220)	60815-U
10"	6908-10
(425225)	60811-U
pk 10	

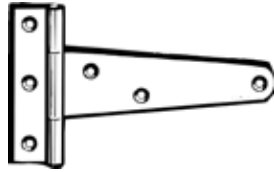

**LIGHT TEE HINGE**

Bulk pack. For general purpose interior and exterior use. Fasteners not included. Zinc plated - US2C

sold / price each hinge

National 284

2"	14-2300
(465056)	N128-421
3"	14-2450
(465058)	N128-504
4"	14-2600
(465060)	N128-579
6"	14-2900
(465064)	N128-694
pk 10	

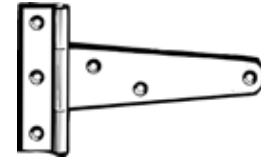

**LIGHT TEE HINGE  
NATIONAL V284**

Designed for applications with narrow frame or post. Zinc plated  
**1 pair per card** with screws

2"	
(465525)	N128-439
3"	
(465526)	N128-512
4"	
(465527)	N128-587
5"	
(465528)	N128-652
pk 5	

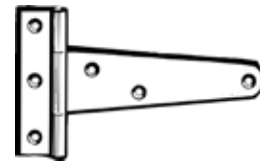

**LIGHT TEE HINGE  
ULTRA HARDWARE**

Pair per card with fasteners. Zinc plated.

sold / price per pair card

2"	CD6904-2
(485115)	60937-U
3"	CD6904-3
(485120)	60938-U
4"	CD6904-4
(485125)	60939-U
pk 10	



BUILDERS HARDWARE



**LIGHT STRAP HINGE**

Pair per card with fasteners. Zinc plated.

**sold / price pair card**

**National V280**

1 pair per card with screws. Zinc plated.

2"	
(465521)	N127-365
3"	
(465522)	N127-449
4"	
(465523)	N127-514
5"	
(465524)	N127-605
pk 5	

**Ultra Hardware**

2"	05262
(485225)	60933-U
3"	18203
(485230)	60934-U
4"	18204
(485235)	60935-U
pk 10	



**LIGHT STRAP HINGE**

Bulk pack  
For basement cupboards, tool boxes and interior uses. Fasteners not included. Zinc plated. US2C

**sold / price each hinge**

**National 280**

2"	14-0150
(465002)	N127-357
3"	14-0300
(465004)	N127-431
4"	14-0450
(465006)	N127-506
6"	14-0800
(465008)	N127-639
pk 10	

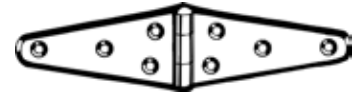

**HEAVY STRAP HINGE**

Bulk pack  
For all types of exterior work on barn doors, large gates, etc. Fasteners not included. Zinc plated. US2C

**sold / price each hinge**

**National 282BC**

4"	14-1270
(465010)	N127-969
5"	14-1370
(465012)	N128-017
6"	14-1500
(465014)	N128-074
pk 10	
8"	14-1620
(465016)	N128-157
10"	14-1720
(465018)	N127-878
12"	14-802
(465020)	N127-910
pk 5	

**Ultra Hardware**

4"	06224
(425135)	60807-U
5"	06225
(425140)	60808-U
6"	06226
(425145)	60809-U
8"	06228
(425150)	60810-U
pk 10	



BUILDERS HARDWARE



**LIGHT NARROW HINGES  
NATIONAL V508**

Removable pin. For light cabinet and general work. Pair per card with screws.

Zinc plated US2C

1"	
(465626)	N141-606
1½"	
(465627)	N141-739
2"	
(465628)	N141-838
2½"	
(465629)	N141-945
3"	
(465631)	N142-034
pk 5	

Brass Finish - DB

1"	
(465646)	N141-622
1½"	
(465647)	N141-754
2"	
(465648)	N141-879
2½"	
(465649)	N141-960
3"	
(465651)	N142-067
pk 5	



BUILDERS HARDWARE

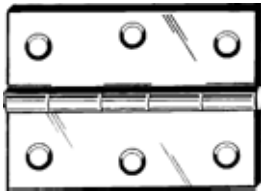

**LIGHT NARROW HINGE  
ULTRA HARDWARE**

Non-removable pin. Pair per poly bag with fasteners. Zinc plated.

sold/price per pair - card

1"	52001
(485133)	60923-U
1½"	52015
(485135)	60924-U
2"	52002
(485140)	60925-U
2½"	52025
(485145)	60926-U
3"	52003
(485150)	60927-U
pk 10	

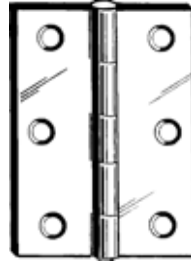

**V518 LIGHT NARROW  
HINGE - NON  
REMOVABLE PIN  
NATIONAL**

For light cabinet and general work. Pair per card with fasteners.

sold/price per card

Zinc plated - US2C

1"	75-4500
(465625)	N145-920
1½"	75-1560
(465630)	N146-043
2"	75-1820
(465635)	N146-159
2½"	75-1950
(465640)	N146-258
3"	75-2060
(465645)	N146-373
pk 5	

Brass Finish - DB

1"	80-2000
(465650)	N145-946
1½"	80-2010
(465655)	N146-068
2"	80-2020
(465660)	N146-175
2½"	80-2030
(465665)	N146-290
3"	80-2040
(465670)	N146-399
pk 5	

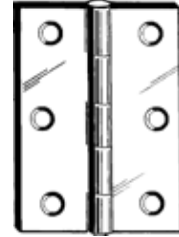

**V518 LIGHT NARROW  
HINGE - NON  
REMOVABLE PIN  
NATIONAL**

For light cabinet and general work. Fasteners not included. Zinc plated - US2C Bulk pack

sold/price each hinge

1"	11-2550
(465022)	N145-912
2"	11-3500
(465026)	N146-146
2½"	11-3700
(465028)	N146-241
3"	11-3900
(465030)	N146-365
pk 20	

Ultra Hardware  
Sold/Price by pair

1"	06661
(425275)	96529-F
1½"	06661-H
(425280)	96531-F
2"	06662
(425285)	96533-F
2½"	06662-H
(425290)	96535-F
3"	06663
(425295)	96537-F
pk 12	



BUILDERS HARDWARE



**SWING N' STAY CAFE  
DOOR HINGE  
NATIONAL V-130**

Heavy duty, gravity action hinge for 3/4" to 1-3/8" thick cafe style door up to 50#. 1 set per card

Brass Finish  
(465551) \_\_\_\_\_ N173-823  
pk 4



**DOUBLE ACTING SPRING  
HINGE  
ULTRA HARDWARE**

Adjustable. No hanging strip required. Fasteners included. Brass Plated.

**sold/ price per pair**  
thickness of doors

	Wood	Metal	Min.	
3"	1"	7/8"	3/4"	6007-3
(425300)				35590-U
4"	1 1/4"	1-1/8"	7/8"	6007-4
(425305)				35595-U
5"	1 1/2"	1-3/8"	1-1/8"	6007-5
(425310)				35596-U
6"	1 3/4"	1 3/4"	1 1/4"	6007-6
(425315)				35597-U

pk 3

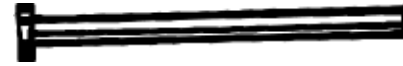

**FLUSH HINGE PIN  
NATIONAL**

Replacement pin for 3 1/2" butts. Satin Brass (US4) hinges. 2 per pack

(465052) \_\_\_\_\_ N234-872  
pk 15

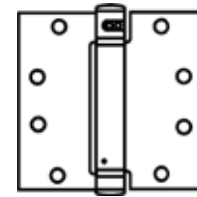

**AUTOMATIC DOOR  
CLOSING HINGE  
NATIONAL V520**

Ideal for residential work. Anti-friction bearings. Non-handed Fully adjustable from free swinging to full tension. 1 hinge per card with fasteners.

Satin Brass Finish  
3 1/2" \_\_\_\_\_ 53-0743  
(465100) \_\_\_\_\_ N184-556  
4" \_\_\_\_\_ N184-572  
(465043) \_\_\_\_\_  
pk 2



BUILDERS HARDWARE



512RC



35226

**ROUND CORNER HINGE**

**NATIONAL**

Item	Pack	Part #	HDI #
For use on interior doors when hollow core or other light-weight doors are used. Non-rising removable pin. Hole in bottom tip for easy pin removal. Pair per box with screws.			
<b>512RC - 1/4" Round Corners</b>			
3" - Satin Brass - pair	5	N143-966	465045
3 1/2" - Satin Brass - each	15	N830-263	465094
4" - Satin Brass - each	15	N830-264	465051
3 1/2" - Satin Chrome - each	15	N830-236	465097
3 1/2" - Satin Nickel - each	15	N830-245	465923
4" - Satin Nickel - Pair	5	N325-027	465924
3 1/2" - Satin Brass - Visual Pac	5	N186-916	465073
4" - Satin Brass - Visual Pac	5	N186-932	465075
3 1/2" - Bright Brass - Visual Pac	5	N190-231	465047
4" - Bright Brass - Visual Pac	5	N190-249	465049

**ULTRA HARDWARE**

Item	Pack	Part #	HDI #
For use on interior doors when hollow core or other light-weight doors are used. Non-rising removable pin. Hole in bottom tip for easy pin removal. Pair per box with screws.			
<b>5/8" Radius Corner</b>			
3 1/2" - Bright Brass US3	25	35226	420700
3 1/2" - Satin Brass US4	25	35220	420701
3 1/2" - Satin Nickel US15	25	35042	420702
3 1/2" - Oil Rubbed Bronze US10B	25	35041	420703
3 1/2" - Antique Pewter US15A	25	35043	420704
3 1/2" - Polished Chrome US26	25	35044	420705



**SQUARE CORNER HINGE**

**NATIONAL**

Item	Pack	Part #	HDI #
For use on interior doors when hollow core or other light-weight doors are used. Non-rising removable pin. Hole in bottom tip for easy pin removal.			
<b>512/V512 - Square Corners</b>			
3" - Satin Brass - Boxed	15	N830-232	465044
3 1/2" - Satin Brass - Boxed	15	N830-230	465046
4" - Satin Brass - Boxed	5	N143-040	465050
3 1/2" - Satin Brass - Visual Pac	5	N176-628	465065
4" - Satin Brass - Visual Pac	5	N176-644	465067
3 1/2" - Antique Brass - Visual Pac	5	N176-636	465069
4" - Antique Brass - Visual Pac	5	N176-651	465071
3 1/2" - Bright Brass - Visual Pac	5	N190-082	465053
4" - Bright Brass - Visual Pac	5	N190-108	465055
3 1/2" - White - Visual Pac	5	N240-457	465057
4" - White - Visual Pac	5	N240-465	465077
3" - Black - Visual Pac	5	N241-182	465059
3 1/2" - Black - Visual Pac	5	N241-190	465061
4" - Black - Visual Pac	5	N241-208	465062



BUILDERS HARDWARE

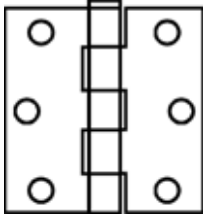

**BROAD REMOVABLE PIN HINGE**

**NATIONAL 504**

For general utility work. Not recommended for use on regular weight doors. All sizes have five knuckles.

**sold/ price each hinge**

Zinc Plated US2C

2" 12-0100  
(465034) N139-683  
pk 5

2 1/2" 12-0300  
(465036) N139-766

3" 12-0550  
(465038) N139-832  
pk 20

3 1/2" 12-0800  
(465040) N139-915

4" 12-1000  
(465042) N140-020  
pk 10

**2 per card with screws**

2 1/2" 12-0300  
(465580) N195-644

3" 12-0550  
(465569) N195-651

3 1/2" 12-0800  
(465570) N195-669

pk 5

**1 per card with screws**

4" 12-1000  
(465571) N195-677

pk5

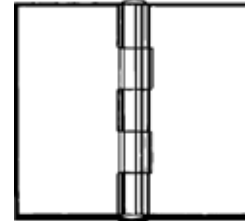

**EXTRA HEAVY FULL SURFACE HINGE**

**NATIONAL 560**

No hole construction and non-removable pin. Not swagged for full surface on weld applications. For window grills, steel shutters, iron gates or for general utility heavy duty requirements. All sizes have five knuckles.

**sold / price each hinge**

Plain steel - PS

2" 12-7400  
(465120) N147-504

2 1/2" 12-7600  
(465121) N147-579

3" 12-7850  
(465122) N147-694

pk 20

3 1/2" 12-8100  
(465124) N147-777

4" 12-8350  
(465126) N147-884

pk 10





BUILDERS HARDWARE

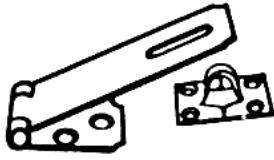

**SAFETY HASP**  
**ULTRA HARDWARE**  
Fixed staple, Poly Pack

Fasteners included

2 1/2"	11225P
(425115)	96460-F
3 1/2"	11235P
(425120)	96461-F
4 1/2"	11245P
(425125)	96462-F
pk 12	

**1 per card** with fasteners  
Zinc - US2C

2 1/2"	11225
(485095)	32000-U
pk 10	
3 1/2"	11235
(485100)	32005-U
4 1/2"	11245
(485105)	32010-U
6"	11206
(485110)	32015-U
pk 10	

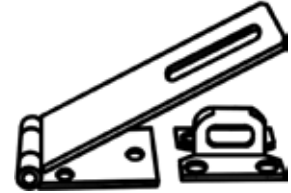

**SAFETY HASP**  
**NATIONAL 30**

Ribbed for added strength. Hot-dipped galvanized coating.  
**bulk pack** without fasteners

Zinc - US2C

2 1/2"	51-1250
(465132)	N102-137
3 1/2"	51-1500
(465134)	N102-269
4 1/2"	51-1650
(465136)	N102-376
6"	51-1800
(465138)	N102-442
pk 10	

**carded** with fasteners

Zinc - US2C

1 3/4"	
(465677)	N102-020
2 1/2"	75-4550
(465680)	N102-145
pk 5	
3 1/4"	75-4543
(465685)	N102-277
4 1/2"	75-4579
(465690)	N102-384
pk 8	

6"	
(465695)	N102-459
pk 5	

Brass Finish

1 3/4"	
(465676)	N102-053
2 1/2"	80-1600
(465675)	N102-178
pk 5	



BUILDERS HARDWARE

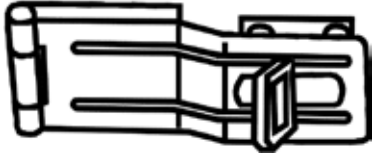

**SAFETY HASP  
NATIONAL 32**

Swivel post. Latchable without padlock or can be locked with padlock. Ribbed leaf for strength.

**Carded** with fasteners  
Zinc US2C

3 1/4" 75-5200  
(465705) N102-855

4 1/2" 75-5210  
(465710) N102-921

pk 5

**Bulk pack** without fasteners  
Zinc US2C

3 1/4" 51-6150  
(465152) N226-480

pk 20

4 1/2" 51-6300  
(465154) N102-905

pk 50

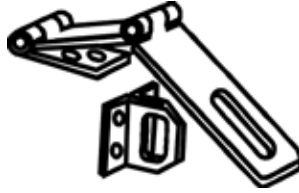

**DOUBLE HINGE  
SAFETY HASP  
NATIONAL V34**

For chests, tool boxes, sliding doors, etc. Slotted portion has turned up end. When fastened, all screws are concealed.

**1 per card** with screws  
Zinc US2C

3 1/4" 75-5250  
(465357) N103-259

4 1/2" 75-5250  
(465358) N103-291

pk 5

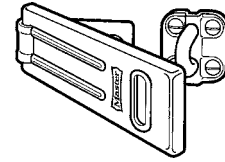

**SECURITY HASP  
MASTER LOCK CO.**

Heavy, steel construction for use with padlocks. Case hardened steel locking eye. High security pinless hinge. Fully enclosed mounting screws.

3 1/2" 75-5250  
(460285) 703-D

4 1/2" 75-5250  
(460290) 704-D

6" case hardened steel  
(460295) 706-D

pk 4



BUILDERS HARDWARE



**WIRE STAPLE**

**NATIONAL 2080**

Heavy duty construction. Sharp diamond points.

Zinc (US2C)  
2 1/2" 29-3720  
(465290) N121-947  
pk 50



**NATIONAL V30S**

For use to replace damaged staples. Can be used in custom applications.

**Bulk pack** without fasteners  
Zinc US2C  
#3 (3 1/4", 4" and 6" hasps)  
1 5/8W x 1 1/4"L 14-6501  
(465160) N102-624  
pk 20



**HINGE HASP**

**NATIONAL V288**

For full surface application. Slotted portion has turned up end. Strap may be bent to fit installation.

**carded** with screws

Zinc US2C  
3" 51-2500  
(465140) N129-577  
pk 10  
4" 51-2800  
(465142) N129-627  
pk 5



BUILDERS HARDWARE

V118



V119



MENDING PLATES / BRACES

ULTRA HARDWARE

Item	Pack	Part #	HDI #
Reinforces joints, seams, cracks. Zinc			
<b>4 Per Card w/Fasteners</b>			
2"	10	60964-U	485155
2½"	10	60966-U	485170
3"	10	60968-U	485160
4"	10	60970-U	485165
<b>Bulk - No Fasteners</b>			
2"	48	97039-U	425005
2½"	48	97042-U	425010
3"	48	97045-U	425015
4"	48	97048-U	425020
5"	20	60821	425025
6"	24	97054-F	425030

NATIONAL

Item	Pack	Part #	HDI #
<b>V118</b> - Reinforces joints, seams, cracks. Zinc			
<b>4 Per Card w/Fasteners</b>			
2" x ½"	10	N114-314	465725
3" x 5/8"	10	N114-355	465730
4" x 5/8"	5	N114-405	465735
<b>Bulk - No Fasteners</b>			
N114-306 2" x ½"	40	N272-716	465218
N114-348 3" x 5/8"	40	N272-724	465220
N114-397 4" x 5/8"	20	N272-732	465222
N114-439 5" x 5/8"	20	N272-740	465224
6" x ¾"	10	N220-285	465226
8" x 7/8"	10	N220-293	465227
10" x 1"	5	N220-327	465229
12" X 1 1/8"	5	N220-335	465231
<b>V119</b> - For reinforcing, attaching connecting or splicing.			
<b>4 Per Card w/Screws</b>			
1½" x 1 3/8"	5	N220-087	465724
2½" x 1 3/8"	5	N220-103	465588
3½" x 1 3/8"	5	N220-111	465589



T PLATES

NATIONAL

Item	Pack	Part #	HDI #
<b>V116</b> - Provides strong reinforcement to wood boxes, crates, toys, furniture, screens and windows. Reinforces joints, seams and cracks. Zinc			
<b>2 Per Card w/Screws</b>			
3"	5	N113-704	465766
4"	5	N113-753	465767
<b>Bulk - No Fasteners</b>			
N113-696 3"	20	N286-429	465230



BUILDERS HARDWARE



**FLAT CORNER IRON**

ULTRA HARDWARE

Item	Pack	Part #	HDI #
Reinforces flat right angle corner joints. For corner joints of wood boxes, crates, screens, windows and doors. Zinc US2C			
<b>4 Per Card w/Fasteners</b>			
1½"	10	60985-U	485203
2"	10	60987-U	485205
2½"	10	60989-U	485210
3"	10	60991-U	485215
<b>Bulk - No Fasteners</b>			
96044-F 1½"	48	61126	425235
96047-F 2"	48	61127	425240
96049-F 2½"	48	61128	425245
96056-F 4"	20	60830	425260
5"	24	96058-F	425265
96061-F 6"	10	60832	425270

NATIONAL

Item	Pack	Part #	HDI #
<b>117</b> - Reinforces flat right angle corner joints. For corners on wood boxes, crates, screens, windows & doors. Zinc US2C			
<b>4 Per Card w/Fasteners</b>			
1½"	5	N113-795	465770
2"	5	N113-845	465775
2½"	5	N113-928	465780
3"	5	N113-969	465785
3½"	5	N114-025	465786
4"	5	N114-116	465787
<b>Bulk - No Fasteners</b>			
N113-787 1½"	40	N266-460	465202
N113-837 2"	40	N266-486	465204
N113-910 2½"	40	N266-502	465206
N114-017 3½"	20	N266-544	465210
N114-108 4"	20	N266-569	465212
N114-140 5"	20	N235-955	465214
N114-199 6"	25	N235-963	465216



**CHAIR CORNER BRACE**

NATIONAL

Item	Pack	Part #	HDI #
<b>V120</b> - 1 x ¾". 4 per card with screws			
Zinc Finish	5	N229-112	465590
Antique Bronze Finish	5	N176-347	465768



**BUILDERS HARDWARE**



**CORNER BRACES**

**ULTRA HARDWARE**

Item	Pack	Part #	HDI #
Reinforces right angle corner joints. Zinc			
<b>4 Per Card w/Fasteners</b>			
1"	10	16400-U	485175
1½"	10	16405-U	485180
2"	10	16410-U	485185
2½"	10	16415-U	485190
3"	10	16420-U	485195
<b>Bulk - No Fasteners</b>			
95989-F 1"	48	61120	425160
95993-F 1½"	48	61121	425165
95996-F 2"	48	61122	425170
95999-F 2½"	24	61123	425175
3"	24	96002-F	425180
96005-F 3½"	24	61125	425185
96008-F 4"	10	60826	425190
96011-F 5"	10	60827	425195
96014-F 6"	10	60828	425200



V113



V114



V115

**CORNER BRACES**

**NATIONAL**

Item	Pack	Part #	HDI #
<b>V113</b> - Designed for furniture, countertops, shelving supports. Zinc			
<b>4 Per Card w/Screws</b>			
1½" x ¾"	5	N206-920	465748
2½" X ¾"	5	N220-061	465585
3½" X ¾"	5	N220-079	465586
<b>V114</b> - Repair Corner Brace. Two sided corner brace for right angle reinforcement. Zinc Plated			
<b>4 Per Card w/Screws</b>			
2" x 5/8"	5	N245-704	465406
2½" X 5/8"	5	N245-720	465407
3" X 5/8"	5	N245-407	465408
4" X 5/8"	5	N245-415	465409
<b>V115</b> - Reinforces right angle corner joints. Screw holes are staggered in 5" and larger.			
<b>2 Per Card</b>			
1"	5	N113-050	465749
1½"	5	N113-154	465750
2"	5	N113-308	465755
2½"	5	N113-233	465760
3"	5	N113-456	465765
3½"	5	N113-399	465761
<b>Bulk - No Fasteners</b>			
N113-035 1"	40	N266-270	465182
N113-118 1½"	40	N266-304	465184
N113-282 2"	40	N266-361	465186
N113-217 2½"	40	N266-338	465188
N113-431 3"	40	N266-395	465190
N113-506 4"	10	N220-145	465194
N113-563 5"	10	N220-152	465196
N113-613 6"	10	N220-160	465198
N113-654 8"	5	N220-178	465200
N113-175 10"	5	N220-186	465201



BUILDERS HARDWARE

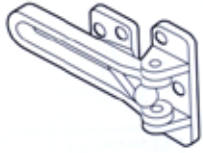

**DOOR FLIP GUARDS**

Don-Jo

**Brass**

(427008) 1603-605

**Satin Chrome**

(427032) 1603-626

pk 10



BUILDERS HARDWARE

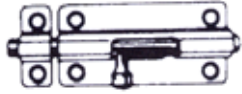

**BRASS BARREL BOLT  
ULTRA HARDWARE**

Decorative barrel bolt for average weight doors. 1 per card with screws.

2½	41325
(425065)	60876-U
3"	41303
(425070)	60877-U
4"	41304
(425075)	60879-U
5"	41305
(425080)	60883-U
6"	41306
(425085)	60881-U
pk 10	



**HEAVY DUTY BARREL  
BOLT  
NATIONAL V831**

For use on cabinets, doors, and gates requiring greater security. 1 per card with screws.

Zinc Plated US2C

4"	22-7110
(465176)	N162-370
6"	22-7210
(465178)	N162-388
pk 5	

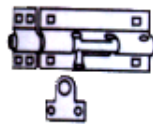

**EXTRA HEAVY BARREL  
BOLT  
NATIONALV832**

Designed for heavy-duty installation. 1 per card with screws

Zinc Plated US2C

5"	
(465177)	N151-118
pk 2	
8"	
(465180)	N151-167
pk 2	



**BARREL BOLT  
NATIONAL V834**

Multi-purpose barrel bolt for average weight doors. Reversible strike engages at either end of bolt. 1 per poly bag with screws.

Zinc Plated US2C

2½"	81-3200
(465166)	N227-314
3"	81-3220
(465168)	N227-330
4"	81-3240
(465170)	N227-355
pk 20	

1 per card with screws

2½"	75-7820
(465820)	N151-449
3"	75-7950
(465825)	N151-555
4"	75-8080
(465830)	N151-654
pk 10	

5"	
(465172)	N151-738
pk 5	

Brass Finish DB

2½"	75-7802
(465805)	N151-480
3"	75-7931
(465810)	N151-589
4"	75-8062
(465815)	N151-688
pk 10	





BUILDERS HARDWARE

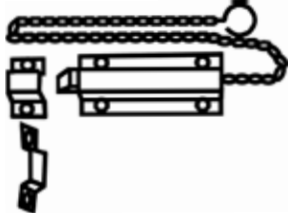

**CHAIN BOLT**  
NATIONAL V820

For doors of garages & industrial buildings. Can be used on doors opening in by reversing bolt. Automatic spring operated bolt return. 21" chain.

**1 per card** with screws

Zinc Plated

6" 81-2550  
(465306) N150-771  
pk 2



**FOOT BOLT**  
NATIONAL V830

For garages & industrial buildings. Operated by pressure of the foot on the cap and released by pressure on the trip.

**1 per card** with screws

Zinc Plated

6" 81-2650  
(465310) N151-027  
pk 2



**CHEST HANDLE**  
NATIONAL V175

For chest or boxes where a sturdy handle is required. Vertical corrugations reinforce the top. 2-11/16 x 2" plate width x length. 2 3/4" bail inside diameter.

**1 per card** with screws

Zinc Plated

2 3/4" 33-1301  
(465320) N203-760  
3 1/2" 33-4180  
(465323) N117-002  
pk 5

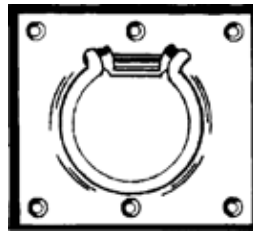

**TRAP DOOR RING**  
NATIONAL V177

Mortised design for flush installation. Bail stores flush with mounting plate. Helps minimize danger of tripping.

3 x 3 1/2" plate width x length.  
1 1/2" inside bail diameter.  
1/2" mortise depth.

**1 per card** with screws

Zinc Plated

57-4800  
(465322) N203-752  
pk 5

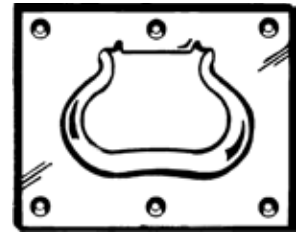

**FLUSH DOOR AND CHEST HANDLE**  
NATIONAL V176

Flush mount handle. 5 1/4 x 4 1/4" plate size. 2 3/4" grip opening.

**1 per card** with screws

Zinc Plated

(465321) N185-975  
pk 5



BUILDERS HARDWARE



**FULL SURFACE SCREEN  
DOOR HINGE  
NATIONAL V122**

For full surface applications on light residential screen doors. Self-closing. Tight pin

2 13/16" x 2 3/4"

Pair per card with screws

Zinc Plated US2C      81-0317  
(465236)                      N190-736  
pk 5



**SCREEN DOOR HINGE  
NATIONAL V129**

Will accommodate door thicker than jamb. Applications of either full surface or half surface. Pair per card with screws

Zinc Plated US2C                      81-4550  
3 x 2 1/2"                                      N115-519  
(465242)

Brass Finish                                      N115-477  
(465249)  
pk 5



**FULL SURFACE SPRING  
SCREEN DOOR HINGE  
NATIONAL V123**

Self-closing. Tension of spring factory set. Pair per card with screws

Satin Brass                                      N114-785  
3"    (465240)  
pk 5



**ADJUSTABLE FULL  
SURFACE SPRING HINGE  
NATIONAL V125**

Self-closing. Adjustable to provide desired closing speed. Pair per card with screws

Zinc Plated                                      81-0350  
3"    N192-773  
(465243)                                      N115-055

Brass Finish                                      N115-006  
3"    (465241)  
pk 2



**SCREEN DOOR CATCH  
NATIONAL V1367**

For holding screen and storm door shut. 1 per card with screws

Zinc Plated US2C                      81-0350  
(465260)                                      N192-773  
pk 3



**SCREEN & STORM DOOR  
SET  
NATIONAL V90**

Everything needed to hand and equip a screen or storm door. Set includes one pair of hinges, one door pull, one hook and eye, and one coil spring. 1 set per pack with screws.

Zinc Plated US2C                      81-4542  
(465246)                                      N107-425  
pk 5



BUILDERS HARDWARE

FULL TURN BUTTON



NATIONAL

Item	Pack	Part #	HDI #
<b>83</b> - 3/4" length. For use on storm sash, screens and cupboard doors.			
Zinc Plated 4 per card with screws	10	N106-815	465255
57-0450 Bulk pack with screws	100	N106-807	465254

SCREEN HANGER



NATIONAL

Item	Pack	Part #	HDI #
<b>V80</b> - For full length screens and storm sash. <b>Pair per card</b> with screws.			
81-4500 Zinc Plated US2C	5	N106-682	465248

WINDOW PINS



ULTRA

Item	Pack	Part #	HDI #
For sliding patio doors 1/4" pin 1 per poly bag			
	100	57000-U	394204



SNAP FASTENER

NATIONAL

Item	Pack	Part #	HDI #
<b>V82</b> - Seals windows against drafts, saves fuel. Spring tension stops rattles and vibrations. Many other holding applications.			
PB-36 - 4 per card with screws	5	N192-179	440150



WINDOW SPRING BOLT

STANLEY

Item	Pack	Part #	HDI #
<b>1697</b> - 3 1/4" Plated.			
	25	57-6090	465401



HALF TURN BUTTON

NATIONAL

Item	Pack	Part #	HDI #
<b>83 1/2</b> - 1 1/4" length. Use on storm sash, screens and cupboard doors.			
4 per card with screws.	100	N106-906	465257
Bulk pack with screws	100	N106-898	465256

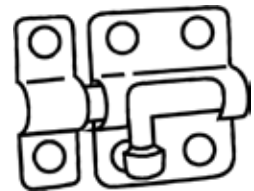

WINDOW BOLTS

NATIONAL

Item	Pack	Part #	HDI #
<b>V833</b> - Designd for security for windows, cabinets and doors. <b>1 per card</b> with screws			
2" Zinc Plated	10	N151-225	465816
2" Brass Finish	10	N151-266	465817
2" White Finish	5	N248-492	465427



BUILDERS HARDWARE



DOOR PULL

NATIONAL

Item	Pack	Part #	HDI #
<b>200</b> - For screen doors, storm doors and drawers. 4¾" length			
<b>1 per card</b> with screws V200			
75-1180 Zinc Plated US2C	10	N117-713	465600
Brass Finish	10	N117-754	465605
<b>Bulk with screws</b> SPB200			
32-1920 Zinc Plated US2C	20	N226-928	465250
32-1680 Brass Finish	30	N226-936	465252



DOOR AND GATE SPRING

NATIONAL

Item	Pack	Part #	HDI #
<b>V850</b> - Adjustable tension spring for gates and doors. 12" length. 1 per card with screws.			
Black Finish	5	N165-498	465871



ADJUSTABLE DOOR AND GATE SPRING

NATIONAL

Item	Pack	Part #	HDI #
<b>V75</b> - Adjustable spring suitable for project using #3 - #6 spring sizes. <b>1 per card</b> with hooks.			
Zinc Plated	10	N175-114	465247

HEAVY DUTY SCREEN DOOR TURNBUCKLES



NATIONAL

Item	Pack	Part #	HDI #
<b>V196</b> - 49-13/16" extended. 47-5/16" closed. To brace, raise or eliminate sag on doors. <b>1 per card</b> with screws.			
Zinc Plated	5	N117-580	465251



DOOR SRRING

NATIONAL

Item	Pack	Part #	HDI #
<b>76BC</b> - 16" length. Steel, zinc painted			
#4 3/8" diameter	10	N235-002	440010
#5 7/16" diameter	10	N235-010	440015
#6 1/2" diameter	10	N235-028	440020



BUILDERS HARDWARE



**STORM DOOR GRILLS**

PRIME-LINE

Item	Pack	Part #	HDI #
<b>Poly Injection Molded Screen &amp; Storm Door Grill</b> - Molded from high quality, rugged polymer plastic. Resist fading, cracking and chipping. Easy to install, no tools required (when mounting with double back tape). Fits doors 30 - 32 - 36" wide. Fasteners included: screws and double backed foam tape.			
20" Black Finish	6	PL15518	495706
20" White Finish	6	PL15517	495707
20" Dark Brown Finish	6	PL15516	495708
<b>Aluminum Screen &amp; Storm Door Grill</b> - Exceptional strength. Extruded frame construction. "Close weave" mesh keeps children's fingers from getting caught. Fits doors 30 - 32 - 36" wide. Screws provided.			
16" Mill Finish	6	PL15925	495715
24" White Finish	6	PL15933	495713



**STORM DOOR STRIKE PLATES**

NATIONAL

Item	Pack	Part #	HDI #
<b>V1350 Strike Plate</b> - Replacement strike with slotted holes for universal use. With screws			
Aluminum	10	N162-016	440120
Black	10	N162-057	440125
White	10	N213-322	440126



**STORM DOOR LOCKS / LATCHES**

NATIONAL

Item	Pack	Part #	HDI #
<b>V1307 Tulip Knob Latch</b> - For outswinging doors 7/8 to 1 1/8" thick. 3" hole spacing. Installs in three 1/4" holes. Backset from jamb (door stop) 1". Spring loaded strike plate			
Aluminum	10	N178-814	440050
Black	10	N178-798	440055
White	3	N212-993	440056
<b>V1308 Knob Latch w/Key</b> - For outswinging door 1 3/8 to 2". 1 1/2", 1 3/4", 3" hole spacing. Keyed lock (2 keys)			
Aluminum	3	N178-822	440042
Black	3	N178-806	440041
White	3	N213-033	440043
<b>V1316 Push Button Latch</b> - For outswinging doors 1 to 1 1/4" thick. 1 3/4" installation hole spacing. Installs in three 1/4" holes. Has "No Lock-Out" feature. Two shims and strikes for latch adjustment.			
Aluminum	3	N178-368	440030
Black	3	N178-350	440035
White	3	N213-074	440037
<b>V1317 Push Button Latch w/Key</b> - For outswinging doors 1 to 1 1/4" thick. 1 3/4" installation holes. Installs in three 1/4" holes. Has "No Lock-Out" feature. Two strikes and shims for latch adjustment			
Aluminum	3	N178-384	440040
Black	3	N178-376	440045
White	3	N213-124	440046
<b>V1326 Push Button Latch</b> - For outswinging doors 1 to 1 1/4" thick. 1 3/4" installation hole spacing. Installs in three 1/4" holes. Free hanging handle. Has "No Lock-Out" feature. Two strikes and shims for latch adjustment			
Aluminum	3	N178-400	440086
Black	3	N178-392	440081
White	3	N213-165	440087



BUILDERS HARDWARE



STORM DOOR HARDWARE

NATIONAL

Item	Pack	Part #	HDI #	
<b>V1355 Spring &amp; Chain Door Stop</b> - Wind chain and spring for storm and screen doors. Helps prevent door closer damage. Mounting brackets and screws included.	5	N162-024	440135	
<b>V1362 Window Control</b> - For new or old double hung wood windows. Made of polished stainless steel for maximum wearing qualities and smooth operation. Controls windows when sash cords are broken. 1 1/4" wide.	1 Pair Per Card	3	N191-544	440145
<b>V1369 Storm Door Clips</b> - For metal installations. Heavy extruded aluminum clips fit most screen or storm door panels. Clips and screws are aluminum, will not rust. 8 per card	Aluminum	5	N192-161	440140

PRIME-LINE

Item	Pack	Part #	HDI #
<b>Storm Door Panel Clips</b> - Aluminum. 3/4" x 1/2" x 1/4"			
8/Card w/Thumb Screws	6	PL7939 P25	495610
25/Tub - No Screws	10	PL14750 B25	495681
<b>Self-Locking Storm Door Panel Clips</b> - Aluminum clips. 1/2" x 3/4"			
8 Per Card w/Thumb Screws	6	PL7955 P54	495611
25/Tub - w/Screws	10	PL14798 B54	495679
<b>Self-Locking Storm Door Panel Clips</b> - Aluminum clips. 1/2" x 3/16" x 3/4"			
25/Tub w/Screw	10	PL14786 B91	495680
<b>Thumb Screws</b> - For use with storm door panel clips. 9/16" x #8-32			
25/Tub	10	PL14768 P832	495682
<b>Aluminum Storm Door Panel Clips</b> - 1" x 1/2", 3/8" x 1/8"			
25/Tub	1	PL14840	495685



STORM DOOR CLOSERS

NATIONAL

Item	Pack	Part #	HDI #
<b>V1333 Pneumatic</b> - Adjustable closing speed. Positive latching assures that the door completely shuts in the latch. Door will swing open approximately 90°.			
Aluminum	3	N181-602	440095
Black	3	N181-610	440100
White	3	N213-207	440102
<b>V1337 Posi-Glide</b> - Adjustable closing speed. Positive latching assures that the door completely shuts in the latch. Door will swing open approximately 90°. Patented Posi-Glide shock-absorbing system for resisting wind damage. Patented design.			
Aluminum	3	N181-628	440092
Black	3	N181-636	440091
White	3	N213-249	440093
<b>V1342 Hydraulic</b> - Adjusts easily by rotating the tube to increase or decrease door closing power. Door will swing open approximately 85°. Offers smooth, no-bounce operation.			
Aluminum	3	N189-704	440105
Black	3	N189-696	440110
White	3	N213-280	440111
<b>V1345 Touch N Hold</b> - For wood or metal outswinging doors. Automatic hold open feature. Full 90° opening. Adjustable closing speed.			
Aluminum	4	N279-778	440115
Black	4	N279-786	440117
White	4	N279-794	440116



BUILDERS HARDWARE



500S

COMMERCIAL DOOR CLOSERS

ULTRA HARDWARE

Item	Pack	Part #	HDI #
<b>500S Series</b> - Meets Grade 2 standards; Dual valve; Atlas brand door closer; UL listed; Narrow design; Furnished w/parallel arm bracket			
#4 Aluminum Finish	10	16126	440215



HINGE PIN DOOR CLOSERS

ULTRA HARDWARE

Item	Pack	Part #	HDI #
Designed to close interior doors automatically. Use on 512 3-1/2" & 4" Hinge and on the 504 3-1/2" & 4" Hinge.			
Satin Brass	10	N208-003	440203



BUILDERS HARDWARE



P7505



P7629

SPLINE TOOLS

PRIME-LINE

Item	Pack	Part #	HDI #
<b>Standard Duty</b> - Wood Handle & Steel Wheel. 1 5/16" x 3/32" Convex Wheel & Concave Wheel			
Carded	10	P7505	495501
<b>Professional</b> - Wood Handle & Steel Ball Bearing Wheel. 2 1/2" x 1/16" Convex Wheel, 2" x 1/8" Concave Wheel			
Carded	5	P7629	495502



SPLINE

PRIME-LINE

Item	Pack	Part #	HDI #
<b>Round Screen</b> - For aluminum and fiberglass screening. Top quality vinyl, round, hollow core, serrated.			
<b>Gray</b>			
1/8" x 250'	1	P7649	495503
9/64" x 250'	1	P7661	495504
5/32" x 500'	1	P7670	495509
11/64" x 250'	1	P7673	495505
3/16" x 250'	1	P7945	495506
<b>Black</b>			
1/8" x 500'	1	P7552	495511
9/64" x 500'	1	P7564	495512
5/32" x 500'	1	P7568	495517
11/64" x 500'	1	P7572	495513
3/16" x 500'	1	P7946	495514
1/4" x 250'	1	P7604	495516
<b>Flat Glass Retainer Spline</b>			
.344 x 200' Gray	1	P8086	495751
.344 x 200' Black	1	P8338	495753
<b>"T" Glass Retainer Spline</b>			
.244 x 200'	1	P8218	495795
<b>"U" Glass Retainer Spline</b>			
.230 x .225 x 200'	1	P7732	495565



PL15302  
PL15300



PL15306  
PL15304

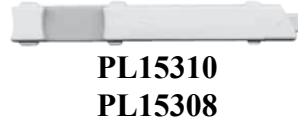

PL15310  
PL15308

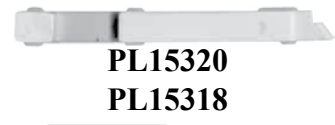

PL15320  
PL15318



PL15324  
PL15322

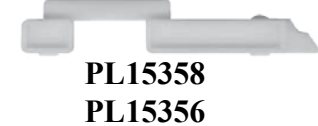

PL15358  
PL15356



PL15362  
PL15360

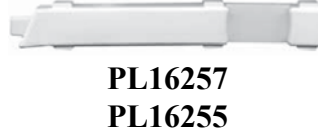

PL16257  
PL16255

SLIDE BOLTS

PRIME-LINE

Item	Pack	Part #	HDI #
<b>Nylon Slide Bolts</b> - 20/Tub			
Right Hand	1	PL15302	495694
Left Hand	1	PL15300	495693
Right Hand	1	PL15306	495692
Left Hand	1	PL15304	495691
Right Hand	1	PL15310	495767
Left Hand	1	PL15308	495765
Right Hand	1	PL15320	495771
Left Hand	1	PL15318	495769
Right Hand	1	PL15324	495775
Left Hand	1	PL15322	495773
Right Hand	1	PL15358	495779
Left Hand	1	PL15356	495777
Right Hand	1	PL15362	495783
Left Hand	1	PL15360	495781
Right Hand	1	PL16257	495787
Left Hand	1	PL16255	495785

SCREEN MOUSE



PHIFER WIRE

Item	Pack	Part #	HDI #
Spline feeds through roller for quick screen installation. Cuts repair time in half. Ergonomic design. Works with any screening project using round spline up to .250" diameter.			
	20	73064	495499





BUILDERS HARDWARE

CORNER KEYS

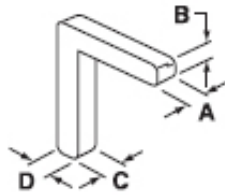

PRIME-LINE

Item	Pack	Part #	HDI #
<b>Nylon Corner Keys - Sold/Price Per Tub - 20/Tub</b>			
3/16"A x 3/16"B	1	PL14950	495650
7/32"A x 3/16"B	1	PL14952	495651
5/32"A x 1/4"B	1	PL14954	495652
5/32"A x 1/4"B	1	PL14956	495653
5/32"A x 7/32"B x 3/32"C x 7/32"D Left Hand	1	PL14960	495655
5/32"A x 7/32"B x 3/32"C x 7/32"D Right Hand	1	PL14962	495656
3/16"A x 3/16"B	1	PL14964	495657
7/32"A x 7/32"B	1	PL14966	495658
3/16"A x 3/16"B x 1/8"C x 3/16"D Right Hand	1	PL14970	495660
3/16"A x 3/16"B	1	PL14974	495757
3/16"A x 3/16"B	1	PL16352	495759
1/4"A x 3/16"B	1	PL16284	495761
<b>Aluminum Corner Keys - Sold/Price Per Package</b>			
3/16"A x 3/16"B - 20/Tub	1	PL15030	495661
3/16"A x 3/16"B - 20/Tub	1	PL15052	495747
3/8" Corners - 100/Box	1	PL14282	495727
1" Corners - 20/Tub	1	PL14252	495719
1 1/4" Corners - 20/Tub	1	PL14250	495717
<b>Plastic Corner Keys - Sold/Price Per Package</b>			
3/8" Gray - 100/Box	1	PL14272	495721
3/8" Bronze - 100/Box	1	PL14273	495723
3/8" White - 100/Box	1	PL14274	495725
3/4" x 5/16" Gray - 100/Box	1	PL14284	495729
3/4" x 5/16" Bronze 100/Box	1	PL14285	495731
3/4" x 5/16" White -100/Box	1	PL14286	495733
3/4" x 5/16" White - 20/Tub 10 Left & 10 Right	1	PL16156	495735
3/4" x 5/16" Brown - 20/Tub 10 Left & 10 Right	1	PL16157	495737
5/8" x 1/4" White - 20/Tub	1	PL14336	495739
3/8" Gray - 20/Tub	1	PL14312	495741
3/8" Bronze - 20/Tub	1	PL14313	495743
3/8" White - 20/Tub	1	PL14314	495745



PL14950



PL14952



PL14954



PL14956



PL14960



PL14962



PL14964

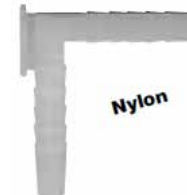

PL14966



PL14970



PL14974



PL16352



PL16284



PL15030



PL15052



PL14282



PL14252



PL14250



PL14272

PL14273

PL14274



Plastic Square Cut

PL14284

PL14285

PL14286

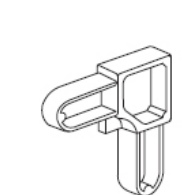

Plastic Square Cut

PL14336



Plastic Square Cut

PL14312

PL14313

PL14314



BUILDERS HARDWARE

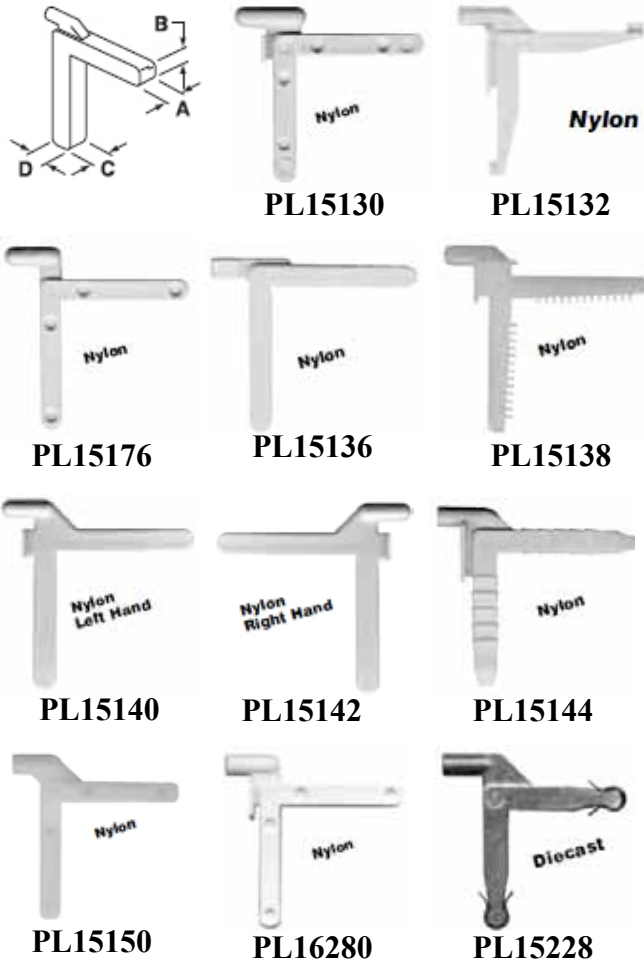

TILT KEYS

PRIME-LINE

Item	Pack	Part #	HDI #
<b>Nylon Tilt Keys - Sold/Price Per Tub - 20/Tub</b>			
3/16"A x 3/16"B	1	PL15130	495663
7/32"A x 3/16"B	1	PL15132	495662
5/32"A x 5/32"B	1	PL15176	495664
3/16"A x 3/16"B	1	PL15136	495666
5/32"A x 1/4"B	1	PL15138	495667
5/32"A x 3/16"B x 3/32"C x 3/16"D Left Hand	1	PL15140	495668
5/32"A x 3/16"B x 3/32"C x 3/16"D Right Hand	1	PL15142	495669
7/32"A x 7/32"B	1	PL15144	495670
3/16"A x 3/16"B	1	PL15150	495671
3/16"A x 3/16"B	1	PL16280	495763
<b>Aluminum Tilt Keys - Sold/Price Per Tub - 20/Tub</b>			
3/16"A x 3/16"B	1	PL15228	495749

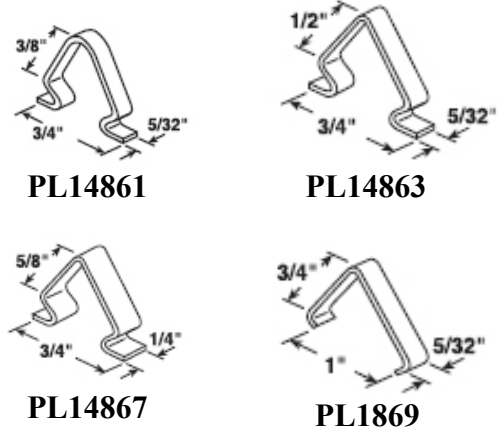

INSERT CLIPS

PRIME-LINE

Item	Pack	Part #	HDI #
<b>Zinc Plated Steel Clips - 25/Tub</b>			
3/8" x 3/4" x 5/32"	1	PL14861	495674
5/8" x 3/4" x 5/32"	1	PL14863	495676
5/8" x 3/4" x 1/4"	1	PL14867	495677
3/4" x 1" x 5/32"	1	PL14869	495678



BUILDERS HARDWARE

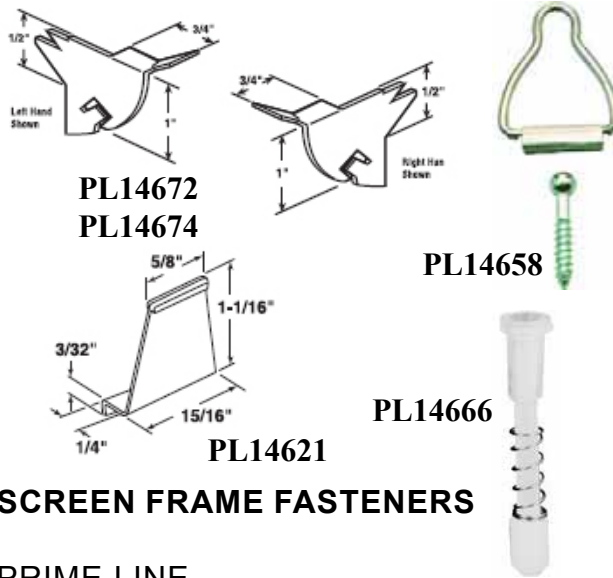

SCREEN FRAME FASTENERS

PRIME-LINE

Item	Pack	Part #	HDI #
<b>Knife Latches</b> - Aluminum. 25/Tub			
Right	1	PL14672	495791
Left	1	PL14674	495793
<b>Spline Channel Bail Latches</b> - Aluminum. Includes fasteners. 25/Tub			
	1	PL14658	495789
<b>Plunger Latches</b> - Nylon. For 3/4" x 3/8" (or 7/16") Frame.			
	1	PL14666	495689
<b>Spline Channel Pull Tabs</b> - Plastic, Black.			
	1	PL14621	495690



PL7738



PL14518

PLASTIC SCREEN CLIPS

PRIME-LINE

Item	Pack	Part #	HDI #
Flush - White, 12 per card	6	PL7738	495613
Flush - White, 25/Tub	1	PL14518	495684
5/16" - White, 25/Tub	1	PL14566	495687
7/16" - White, 25/Tub	1	PL14590	495688

NYLON PANEL CLIPS



PRIME-LINE

Item	Pack	Part #	HDI #
<b>Screen Frame Fasteners</b> - Includes screws.			
Flush, White - 8/Card	6	PL-7919	495612
Flush, White - 25/Tub	1	PL14634	495683

B512

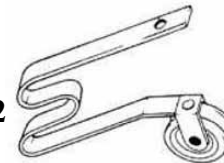

B518



SCREEN DOOR ROLLERS

PRIME-LINE

Item	Pack	Part #	HDI #
Most popular style. Adjustable to fit in many doors. 1" wheel. 2 per pkg	6	B512	495614
Very popular style. Adjustable 1" wheel. 2 per pkg.	6	B518	495615



BUILDERS HARDWARE



**FLEX-O-GLAZE**

WARPS

Item	Pack	Part #	HDI #
.100 (1/10") acrylic safety glazing. Crystal clear, non-yellowing. For windows, kick plates shower door, storm window and door, dust cover, etc. <b>Sold in Full Cartons Only</b> (except 48" x 72", 48" x 96", +12% for less than full carton)			
18" x 24"	10	100M-1824	480241
20" x 28"	5	100M-2028	480243
24" x 28"	5	100M-2428	480245
24" x 48"	5	100M-2448	480247
28" x 30"	5	100M-2830	480249
28" x 32"	5	100M-2830	480251
28" x 38"	5	100M-2838	480253
30" x 32"	5	100M-3032	480255
30" x 34"	5	100M-3034	480257
30" x 36"	5	100M-3036	480259
30" x 60"	5	100M-3060	480261
32" x 40"	5	100M-3240	480263
32" x 44"	5	100M-3244	480265
36" x 36"	5	100M-3636	480260
36" x 72"	5	100M-3672	480271
48" x 72"	5	100M-4872	480275
48" x 96"	5	100M-4896	480277



**PLASTIC & FORMICA CUTTERS**

WARPS

Item	Pack	Part #	HDI #
<b>Cutting Tool for Plastic Glass</b> - Fast accurate cutting of plastic sheet, tile board, vinyl tile, thin aluminum and brass. Carded			
	12	CT-12	480281

FLETCHER

Item	Pack	Part #	HDI #
<b>Plastic Cutter</b> - Double edge plastic cutting tool with two scoring tips for normal or extra pressure scoring of plastics.			
	10	05-111	480283
<b>Cutter for Plastic &amp; Formica</b> - Professional quality heavy duty cutter works on acrylic plastics, plexiglass, formica, tile and most fracture sensitive plastics. Comfortable die cast pistol grip metal handle minimizes fatigue from repeated scoring. Replaceable blade.			
	5	05-120	480285



ALUMINUM SCREEN

PHIFER

Item	Pack	Part #	HDI #
<b>Brite-Kote</b> - Insect screen. Standard of the industry. The aluminum finish is free of streaks, easy to fabricate, and long lasting. 18 x 16 mesh			
24" x 100'	1		495220
28" x 100'	1		495230
30" x 100'	1		495235
32" x 100'	1		495240
36" x 100'	1		495250
48" x 100'	1		495270
60" x 100'	1		495280
72" x 100'	1		495285
<b>Black Aluminum</b> - Black finish is electrodesposition coated for strength and durability. Virtually invisible when looking outward from inside. Ideal for screen porches, decks, or for any window where outward visibility is of prime importance. 18 x 16 mesh			
24" x 100'	1		495481
30" x 100'	1		495482
36" x 100'	1		495483
48" x 100'	1		495484
60" x 100'	1		495485
72" x 100'	1		495486
<b>Charcoal Aluminum</b> - Vista-Weave. Coated with a charcoal finish using our new electrodesposition coating method. Finish is extremely strong and offers improved outward visibility and reduces glare. 18 x 16 mesh			
24" x 100'	1		495300
28" x 100'	1		495310
30" x 100'	1		495315
32" x 100'	1		495320
36" x 100'	1		495330
48" x 100'	1		495350
60" x 100'	1		495355
72" x 100'	1		495360



FIBERGLASS SCREEN

PHIFER

Item	Pack	Part #	HDI #
<b>Phiferglass</b> - Fiberglass screening is woven from permanent glass yarn, which has been coated with a protective vinyl to ensure lasting beauty, color and flexibility. It is produced under the most exacting conditions to meet extremely rigid specifications. Noncombustible and will not rust, corrode, or stain. 18 x 16 mesh.			
<b>Charcoal</b>			
24" x 100'	1		495375
28" x 100'	1		495385
30" x 100'	1		495390
32" x 100'	1		495395
36" x 100'	1		495405
42" x 100'	1		495420
48" x 100'	1		495425
54" x 100'	1		495430
60" x 100'	1		495435
72" x 100'	1		495440
<b>Silver Gray</b>			
24" x 100'	1		495449
30" x 100'	1		495458
36" x 100'	1		495467
48" x 100'	1		495479
<b>BETTER VUE Fiberglass Screen</b> - Improved visibility insect screen (iVis) for windows, doors, and porches. Smaller holes for increased insect protection.			
<b>Charcoal</b>			
36" x 100'	1		495443
48" x 100'	1		495447



BUILDERS HARDWARE



**PET SCREEN**

PHIFER

Item	Pack	Part #	HDI #
Pet resistant insect screening. Seven times stronger than regular insect screening. Resists damage by dogs and cats. Made from strong vinyl coated polyester.			
<b>Black DIY Rolls</b>			
48" x 84"	6		495492
36" x 84"	6		495494
<b>Black Rolls</b>			
36" x 50'	1		495495
36" x 100'	1		495491
48" x 50'	1		495496
48" x 100'	1		495493



CO615



CO600



CO400

**CARBON MONOXIDE DETECTORS**

**FIRST ALERT**

Item	Pack	Part #	HDI #
<b>Plug-In Style</b> - Plug-in carbon monoxide detectors with battery operated backup and backlit digital display. These detectors plug into standard outlets without additional mounting. Plug-in cord offers multiple placement options. Battery operated backup ensures alarm works even during power outages. 5 Year Limited Warranty. Meets UL Standards.			
	3	CO615	391182
<b>Plug-In Style (120V)</b> - The First Alert plug in carbon monoxide detector easily plugs into any standard outlet with no additional mounting necessary. Mute button silences any nuisance alarms. Single button also tests detector functions. This detector utilizes an electrochemical sensor for increased accuracy. 5-year limited warranty. Meets UL standards.			
	3	CO600	391186
<b>Battery Powered</b> - Battery powered carbon monoxide detector from First Alert with mute button to silence any nuisance alarms. Single button also tests alarm functions. Utilizes electrochemical sensor for increased accuracy. Easy, front access to the battery. 5-year limited warranty. Meets UL standards.			
	3	CO400	391184



SA340CN



9120B



SA303CN3



FG200

**SMOKE & FIRE DETECTORS**

**FIRST ALERT**

Item	Pack	Part #	HDI #
<b>Tamper Proof, Battery Operated</b> - The First Alert tamperproof lithium powered alarm is the only one available proven to last at least 10 years without needing to replace power source. 10-year lithium power cells and tamper proof design meet code regulations where required. Mute feature silences nuisance alarms from cooking smoke or shower steam. Single button also tests alarm functions. Easy access battery drawer: no need to remove alarm from ceiling to change battery. 10-year limited warranty. Meets UL standards.			
	3	SA340CN	391162
<b>120V AC/DC</b> - The 9120 Series smoke alarms have been designed to install faster 2C perform better and be even smarter than before. These improvements help reduce nuisance alarms and save you time and money. With battery backup.			
	12	9120B	391104
<b>Battery Operated</b> - This Battery Smoke Alarm is ideal for detecting fast flaming fires. It has a mute button, which silences unnecessary alarms often caused by cooking smoke or shower steam. The Battery Smoke Alarm is best suited to detect smoke from a fast flaming fire. It has a mute button that silences unnecessary alarms often caused by cooking smoke or shower site.			
	6	SA303CN3	391101
<b>Family Gard, Battery Operated</b> - Battery operated ionization smoke alarm with test button, 9 volt battery included. Ionization smoke sensors are generally more sensitive at detecting small particles, which tend to be produced in greater amounts by flaming fires. Beeping signal warns when the battery needs replacing. Hinged cover for easy battery replacement. Meets ANSI/UL217 standard. 3-year limited warranty.			
	6	FG200	391105



BUILDERS HARDWARE



HOME1 GARAGE1 REC5 PRO5



7102

FIRE EXTINGUISHERS

FIRST ALERT

Item	Pack	Part #	HDI #
<b>Home</b> - Rechargeable home fire extinguisher. Monoammonium phosphate extinguishing agent. Effective against fires involving paper, wood, textiles, and plastics as well as flammable liquid fires and electrical fires. US Coast Guard approved. Mounting bracket and strap included.			
1A:10-B:C	4	HOME1	391160
<b>Garage</b> - Corrosion resistant metal valve and trigger, large, easy-to-read color coded pressure gauge. Sodium bicarbonate extinguishing agent. Used to fight flammable liquids and electrical fires. US Coast Guard approved when used with included plastic mounting bracket and strap.			
10-B:C	4	GARAGE1	391168
<b>Recreational</b> - Corrosion resistant metal valve and trigger, large, easy-to-read pressure gauge. Sodium bicarbonate extinguishing agent. Used to fight flammable liquids and electrical fires. U.S. coast guard approved when used with included plastic mounting bracket with strap.			
5-B:C	4	REC5	391161
<b>Heavy Duty</b> - Dry chemical fire extinguisher containing monoammonium phosphate fire extinguishing agent. Commercial grade metal valve and trigger. For use in home offices, small businesses, and light industrial manufacturing applications. Effective against fires involving paper, wood, textiles and plastics as well as flammable liquid and electrical fires. Rechargeable, with large, easy to read color coded pressure gauge.			
3-A:40-BC	2	PRO5	391169

MAX PROFESSIONAL

Item	Pack	Part #	HDI #
<b>Fire Gone</b> - It is a fire extinguisher packaged in a compact and cleverly designed aerosol can. It delivers a strong targeted stream that goes right to the source of the fire, coating it with special formulated, fire fighting foam. Easy to use and simple to clean-up. Made from biodegradable materials. For home, auto, marine, and RV.			
16 oz	6	7102	285105





BUILDERS HARDWARE

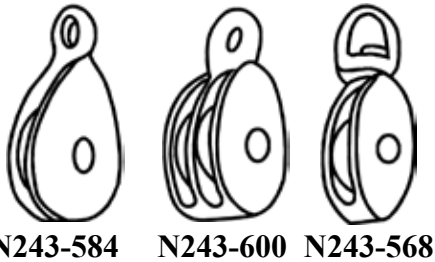

**AWNING PULLEYS**

**STEEL PULLEYS**

**NATIONAL**

**NATIONAL**

Item	Pack	Part #	HDI #
<b>0174 Fixed Eye Awning Pulley</b> - One piece cast construction with triple nickel plating and brass sheaves. (Rope Size)			
1/2" (5/16) T765-5062, 3203BC	10	N243-584	415075
3/4" (1/4) T765-5100, 3203BC	10	N243-592	415077
1" (5/16) T765-5112, 3203BC	10	N223-404	415079
<b>0176 Fixed Eye Double Awning Pulley</b> - One piece construction with triple nickel plating and brass sheaves. (Rope Size)			
3/4" (1/4) T765-5202, 3204BC	5	N243-600	415110
1" (5/16) T765-5212, 3204BC	5	N223-420	415100
<b>0173 Swivel Single Awning Pulley</b> - One piece cast construction with triple nickel plating and brass sheaves. (Rope Size)			
1/2" (5/16) T765-5052, 3201BC	10	N243-568	415087
3/4" (1/4) T765-5002, 3201BC	10	N243-576	415089
1" (5/16) T765-5012, 3201BC	10	N223-370	415091

Item	Pack	Part #	HDI #
<b>3211BC Swivel Eye Single Pulley</b> - Swivel eye helps eliminate tangling. Weatherproof zinc finish. (Rope Size)			
T7550301 1 1/2" (3/8)	5	N195-784	415095
T7550402 2" (1/2)	5	N195-792	415097
T7550303 2 1/2"	2	N219-998	415298
T7550304 3"	2	N220-004	415291
<b>3213BC Fixed Eye Single Pulley</b> - Fixed eye. Weatherproof zinc finish. (Rope Size)			
T765-5132 1 1/2" (3/8)	5	N195-800	415083
T765-5142 2" (1/2)	5	N195-818	415085
T7550403 2 1/2"	2	N220-012	415299
T7550404 3"	2	N220-020	415300
<b>0178 Fixed Eye Double Pulley</b> - One piece cast construction with triple zinc plating and brass sheaves. (Rope Size)			
T7550421 3214BC 1 1/2" (3/8)	5	N199-810	415284

**CAMPBELL**

Item	Pack	Part #	HDI #
<b>Swivel Eye Rope Pulley</b> - Steel body and die cast zinc sheave. Zinc plated to protect against rust & corrosion. Powder metal bushing to extend pulley life and provide smooth operation. For rope up to 3/8" or 1/2" [max. cable size/work load limit]			
1 1/2" [420#]	1	T7550301	415150
2" [480#]	1	T7550302	415151
2 1/2" [550#]	1	T7550303	415152
<b>Fixed Eye Rope Pulley</b> - Steel body and die cast zinc sheave. Zinc plated to protect against rust & corrosion. Powder metal bushing to extend pulley life and provide smooth operation. For rope up to 3/8" or 1/2" [max. cable size/work load limit]			
1 1/2" [420#]	1	T7550401	415153
2" [480#]	1	T7550402	415154
2 1/2" [550#]	1	T7550403	415155



BUILDERS HARDWARE



N233-247



T7550501

WALL / CEILING PULLEYS

NATIONAL

Item	Pack	Part #	HDI #
<b>3219BC Wall/Ceiling Mount Single Pulley</b> - Steel body and axle with zinc die cast sheave. Designed for use with rope or cord. Wall or ceiling mount. Weatherproof. Zinc Finish			
1½"	5	N233-247	415294
2" V3219	5	N233-254	415297

CAMPBELL

Item	Pack	Part #	IBM #
Mount with 3 ach 1½" x 12 screws of #10 bolts with nuts & washers. [max. cable size/work load limit]			
1½" [100#]	1	T7550501	415156
2" [100#]	1	T7550502	415157



JOIST MOUNT SINGLE PULLEY

NATIONAL

Item	Pack	Part #	HDI #
<b>3221BC Joist Mount Single Pulley</b> - Steel body and axle with zinc die cast sheave. Designed for rope or cord. Hook over 1-1/2" dimensional lumber. Weatherproof. Zinc Finish			
2"	2	N233-262	415295



N225-607



N225-573



N223-270

PULLEYS WITH HOOKS

NATIONAL

Item	Pack	Part #	HDI #
<b>3217BC Scissors Hook Single Pulley</b> - Steel body and axle with zinc die cast sheave. Designed for use with rope or cord. Scissor hook for easy rigging. Weatherproof. Zinc Finish			
1½"	5	N225-607	415288
2"	5	N224-615	415289
2½"	2	N225-623	415290
3"	2	N229-013	415293
<b>3215BC Swivel Hook Single Pulley</b> - Steel body and axle with zinc die cast sheave. Designed for use with rope or cord. Weatherproof. Zinc Finish			
1½"	5	N225-573	415285
2"	5	N225-581	415286
2½"	2	N225-599	415287
3"	2	N229-005	415292
<b>3223BC Latching Swivel Hook Single Pulley</b> - Steel body and axle with zinc die cast sheave. Designed for rope or cord. Latching hook. Weatherproof. Zinc Finish			
2"	5	N223-270	415296

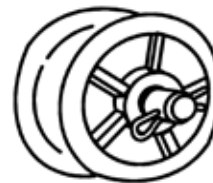

PULLEY SHEAVE ASSEMBLY

NATIONAL

Item	Pack	Part #	HDI #
<b>V3211 Pulley Sheave Assembly</b> - Replacement pulley sheave with pin and cotter key. <b>1 per card</b> Zinc Plated			
1½"	3	N245-886	410850
2"	3	N245-894	410851
2½"	3	N245-902	410852
3"	3	N245-910	410853



**STANDARD SHELF BRACKET**

**NATIONAL 211BC**

Item	Pack	Part #	HDI #
Improved stronger tip design. Sizes that fit standard wall studs and lumber widths. <b>Sold/Price Each</b>			
White Finish			
6 x 8	20	N218-925	465379
8 x 10	20	N218-925	465384
10 x 12	20	N218-958	465389
Fruitwood			
4 x 6	20	N185-017	465376
6 x 8	20	N185-025	465381
8 x 10	20	N185-033	465386
12 x 14	20	N185-058	465396
Gray Finish			
4 x 6	20	N172-601	465375
6 x 8	20	N171-066	465380
8 x 10	20	N171-074	465385
10 x 12	20	N171-082	465390
12 x 14	20	N172-619	465395



**CENTER CLOSET ROD SUPPORT**

**NATIONAL V109C**

Item	Pack	Part #	HDI #
	5	N112-599	465402

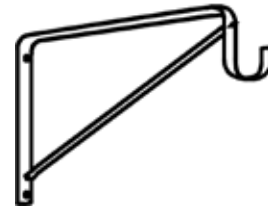

**SHELF AND CLOSET POLE SUPPORT**

**NATIONAL 208BC**

Item	Pack	Part #	HDI #
For use with 1 3/8" diameter rods. Sturdy two piece corrugated design for extra strength. Interlocking brace removes easily to provide access to screwholes. Does not include fasteners			
White Finish	20	N224-501	465400

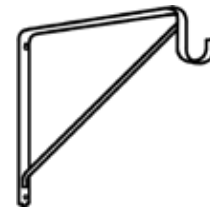

**HEAVY DUTY SHELF AND ROD BRACKET**

**NATIONAL 108BC**

Item	Pack	Part #	HDI #
White	20	N224-428	455190



**SCREWS FOR SHELF BRACKETS**

**NATIONAL V211S**

Item	Pack	Part #	HDI #
7 x 1 1/2 12 per card			
Zinc Plated	10	N206-102	465397



BUILDERS HARDWARE



**SHELF SUPPORT NATIONAL**

*Bulk pack.* Steel for use with 255 or 157 standards.

<b>Brass</b>	256-BR
(455110)	<u>N189-183</u>
<b>White</b>	256S-WH
(455112)	<u>N225-185</u>

pk 100



**SHELF SUPPORT NATIONAL**

*Packaged.* Steel. For use the 255 or 157 standards. (8 per pack)

<b>Silver (zinc)</b>	256P-ZC
(455115)	<u>N170-480</u>

pk 10

<b>Brass</b>	256P-BR
(455125)	<u>N189-175</u>

pk 10



**SHELF SUPPORT NATIONAL 159**

Steel shelf support for drilled holes. 1/4" pin size x 3/8" long.

<b>Brass</b>	346BR
(455138)	<u>N224-675</u>
<b>Anochrome</b>	346ANO
(455135)	<u>N189-589</u>

pk 100



BUILDERS HARDWARE



**TABLE LEG BRACE**  
**NATIONAL V8194**  
2 per card with screws

9 1/2" Brass Finish  
(405419) \_\_\_\_\_ N242-230  
pk 5



**CLOSET POLE SOCKET**  
Accommodates rods up to 1-3/8" diameter.

**Ultra Hardware**  
White plastic  
pair per pkg  
(485300) \_\_\_\_\_ 69000-U  
pk 50

**National**  
Brass Finish  
Pair per card w/screws  
(465546) \_\_\_\_\_ N191-551  
pk 10

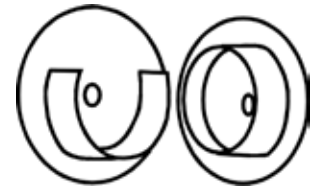

**CLOSET POLE SOCKET**  
**NATIONAL**

White plastic. Accommodates rods up to 1-3/8" in diameter.  
Pair per pkg

Carded with screws  
V-107  
(465547) \_\_\_\_\_ N154-567  
pk 8

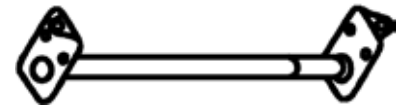

**ADJUSTABLE CLOSET**  
**ROD**

**NATIONAL DPV-209**  
Adjustable telescoping tubing. Easy to install. 1 per pack with screws.

Zinc - US2C  
18" - 30" \_\_\_\_\_ N338-301  
(465500) \_\_\_\_\_ N189-621

30 - 48" \_\_\_\_\_ N338-319  
(465505) \_\_\_\_\_ N189-639

48 - 72" \_\_\_\_\_ N338-323  
(465510) \_\_\_\_\_ N189-647

72 - 120" \_\_\_\_\_ N338-335  
(465515) \_\_\_\_\_ N189-654

pk 10



BUILDERS HARDWARE

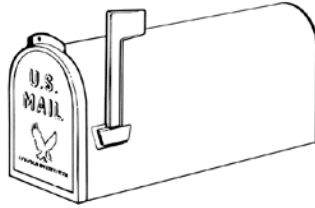

**PLASTIC RURAL MAIL BOX**  
**SOLAR GROUP**

Sturdy, rustproof, 100% copolymer will not warp, chip, crack, dent, fade or peel. Fully assembled for easy post mounting.

#1 Standard Size  
Black

(770055) \_\_\_\_\_ PL10B0201

White

(770056) \_\_\_\_\_ PL10W020

pk 1



**DECORATIVE #1**  
**STANDARD SIZE**

Realistic graphics screened on a polycarbonate sheeting.

American Flag

(770058) \_\_\_\_\_ 6530US

pk 1



**STEEL RURAL MAILBOX**  
**SOLAR GROUP**

Made of galvanized steel with a ribbed design.

#1 Standard Size

18½L x 7½H x 6½W

Silver Gray

(770011) \_\_\_\_\_ ST10000

Black

(770013) \_\_\_\_\_ E1100B00

PK 1

#1½ Medium Size

21L x 10½H x 8W

White

(770015) \_\_\_\_\_ E1000W00

Black

(770017) \_\_\_\_\_ E1600B00

pk 1

#2 Large Size

23½L x 14H x 11W

Silver Gray

(770019) \_\_\_\_\_ ST200000

Black

(770021) \_\_\_\_\_ ST200B00

pk 1





BUILDERS HARDWARE



**PACKAGED NUMBERS**

HY-KO

2" mylar numbers  
Gold on a black background  
Self adhesive  
Durable  
One card covers one job

(430126) MM-3N  
pk 10



**PACKAGED NUMBERS & LETTERS**

HY-KO

1" numbers and letters  
Gold on a black background  
Self adhesive  
Durable  
One card covers one job

(430124) MM-2  
pk 10



**PACKAGED LETTERS**

HY-KO

3" vinyl letters  
Black on a white background  
Self adhesive  
Durable  
One card covers one job

(430128) MM-4L  
pk 10



**PACKAGED NUMBERS**

HY-KO

3" vinyl numbers  
Black on a white background  
Self adhesive  
Durable  
One card covers one job

(430131) MM-4N  
pk 10



BUILDERS HARDWARE



3" Black  
30411



1 1/2"  
GR10-A

**PRESSURE SENSITIVE (BOAT) LETTERS AND NUMBERS**

Self adhesive characters made from mylar. Press into place on any clean surface. Ideal for boats, snowmobiles, trucks, mailboxes, etc. 10 per pkg. *sold/price per pkg.*

Item	Pack	Part #	HDI #
<b>Black - Hyko 3"</b>			
A	1	30411	435001
B	1	30412	435002
C	1	30413	435003
D	1	30414	435004
E	1	30415	435005
F	1	30416	435006
G	1	30417	435007
H	1	30418	435008
I	1	30419	435009
J	1	30420	435010
K	1	30421	435011
L	1	30422	435012
M	1	30423	435013
N	1	30424	435014
O	1	30425	435015
P	1	30426	435016
Q	1	30427	435017
R	1	30428	435018
S	1	30429	435019
T	1	30430	435020
U	1	30431	435021
V	1	30432	435022
W	1	30433	435023
X	1	30434	435024
Y	1	30435	435025
Z	1	30436	435026
1	1	30401	435027
2	1	30402	435028
3	1	30403	435029
4	1	30404	435030
5	1	30405	435031
6	1	30406	435032
7	1	30407	435033
8	1	30408	435034
9	1	30409	435035
0	1	30410	435036

Item	Pack	Part #	HDI #
<b>White - Hyko 3"</b>			
A	1	30511	435037
B	1	30512	435038
C	1	30513	435039
D	1	30514	435040
E	1	30515	435041
F	1	30516	435042
G	1	30517	435043
H	1	30518	435044
I	1	30519	435045
J	1	30520	435046
K	1	30521	435047
L	1	30522	435048
M	1	30523	435049
N	1	30524	435050
O	1	30525	435051
P	1	30526	435052
Q	1	30527	435053
R	1	30528	435054
S	1	30529	435055
T	1	30530	435056
U	1	30531	435057
V	1	30532	435058
W	1	30533	435059
X	1	30534	435060
Y	1	30535	435061
Z	1	30536	435062
1	1	30501	435063
2	1	30502	435064
3	1	30503	435065
4	1	30504	435066
5	1	30505	435067
6	1	30506	435068
7	1	30507	435069
8	1	30508	435070
9	1	30509	435071

**PRESS ON ANODIZED GOLD ALUMINUM NUMBERS/LETTERS**

**HY-KO**

Self adhesive - no fasteners needed. Peel off tab from bottom, press onto clean, dry surface. Ideal for mailbox, office doors, luggage, auto doors, etc. Black on gold background. 10 per pkg.

Item	Pack	Part #	HDI #
<b>1 1/2" - sold/price per pkg.</b>			
A	1	GR10-A	430041
B	1	GR10-B	430042
C	1	GR10-C	430043
D	1	GR10-D	430044
E	1	GR10-E	430045
F	1	GR10-F	430046
G	1	GR10-G	430047
H	1	GR10-H	430048
I	1	GR10-I	430049
J	1	GR10-J	430050
K	1	GR10-K	430051
L	1	GR10-L	430052
M	1	GR10-M	430053
N	1	GR10-N	430054
O	1	GR10-O	430055
P	1	GR10-P	430056
Q	1	GR10-Q	430057
R	1	GR10-R	430058
S	1	GR10-S	430059
T	1	GR10-T	430060
U	1	GR10-U	430061
V	1	GR10-V	430062
W	1	GR10-W	430063
X	1	GR10-X	430064
Y	1	GR10-Y	430065
Z	1	GR10-Z	430066
Blank	1	blank	430067
Hyphen	1	hyphen	430068
Period	1	period	430069
Comma	1	comma	430070
1	1	GR10-1	430071
2	1	GR10-2	430072
3	1	GR10-3	430073
4	1	GR10-4	430074
5	1	GR10-5	430075
6	1	GR10-6	430076
7	1	GR10-7	430077
8	1	GR10-8	430078
9	1	GR10-9	430079
0	1	GR10-0	430080





BUILDERS HARDWARE

REFLECTIVE VINYL  
NUMBERS / LETTERS

HY-KO

Self adhesive. Long lasting. Weather resistant. Commercial, residential. Coast Guard approved. Black on silver background.

10 per pkg sold / price per pkg

1"

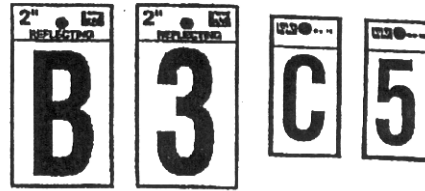

1"		2"		3"	
(430240)	RV15-A				
(430241)	RV-15B				
(430242)	RV-15C	(430355)	RV25-A	(430280)	RV50-A
(430243)	RV-15D	(430356)	RV-25B	(430281)	RV-50B
(430244)	RV-15E	(430357)	RV-25C	(430282)	RV-50C
(430245)	RV-15F	(430358)	RV-25D	(430283)	RV-50D
(430246)	RV-15G	(430359)	RV-25E	(430284)	RV-50E
(430247)	RV-15H	(430360)	RV-25F	(430285)	RV-50F
(430248)	RV-15I	(430361)	RV-25G	(430286)	RV-50G
(430249)	RV-15J	(430362)	RV-25H	(430287)	RV-50H
(430250)	RV-15K	(430363)	RV-25I	(430288)	RV-50I
(430251)	RV-15L	(430364)	RV-25J	(430289)	RV-50J
(430252)	RV-15M	(430365)	RV-25K	(430290)	RV-50K
(430253)	RV-15N	(430366)	RV-25L	(430291)	RV-50L
(430254)	RV15-O	(430367)	RV-25M	(430292)	RV-50M
(430255)	RV15-P	(430368)	RV-25N	(430293)	RV-50N
(430256)	RV15-Q	(430369)	RV25-O	(430294)	RV50-O
(430257)	RV15-R	(430370)	RV25-P	(430295)	RV50-P
(430258)	RV15-S	(430371)	RV25-Q	(430296)	RV50-Q
(430259)	RV15-T	(430372)	RV25-R	(430297)	RV50-R
(430260)	RV15-U	(430373)	RV25-S	(430298)	RV50-S
(430261)	RV15-V	(430374)	RV25-T	(430299)	RV50-T
(430262)	RV15-W	(430375)	RV25-U	(430300)	RV50-U
(430263)	RV15-X	(430376)	RV25-V	(430301)	RV50-V
(430264)	RV15-Y	(430377)	RV25-W	(430302)	RV50-W
(430265)	RV15-Z	(430378)	RV25-X	(430303)	RV50-X
(430266)	RV15-1	(430379)	RV25-Y	(430304)	RV50-Y
(430267)	RV15-2	(430380)	RV25-Z	(430305)	RV50-Z
(430268)	RV15-3	(430381)	RV25-1	(430306)	RV50-1
(430269)	RV15-4	(430382)	RV25-2	(430307)	RV50-2
(430270)	RV15-5	(430383)	RV25-3	(430308)	RV50-3
(430271)	RV15-6	(430384)	RV25-4	(430309)	RV50-4
(430272)	RV15-7	(430385)	RV25-5	(430310)	RV50-5
(430273)	RV15-8	(430386)	RV25-6	(430311)	RV50-6
(430274)	RV15-9	(430387)	RV25-7	(430312)	RV50-7
(430275)	blank	(430388)	RV25-8	(430313)	RV50-8
(430276)	hyphen	(430389)	RV25-9	(430314)	RV50-9
(430277)	period	(430390)	blank	(430315)	blank
(430278)	comma	(430391)	hyphen	(430316)	hyphen
pk 1		(430392)	period	(430317)	period
		pk 1		pk 1	



--	--



BUILDERS HARDWARE



**NUMBER & LETTER STENCIL SET**

**HY-KO PRODUCTS**

Reusable, flexible, water resistant.  
Made of heavy duty stencil board. Set per card includes:

- Numbers 0 - 9
- Letters A - Z
- Period, dash, comma
- ¢, &, \$
- Plus extra A, E O, R, S

1"  
(430222) \_\_\_\_\_ ST-1

2"  
(430224) \_\_\_\_\_ ST-2

3"  
(430226) \_\_\_\_\_ ST-3

4"  
(430228) \_\_\_\_\_ ST-4

5"  
(430230) \_\_\_\_\_ ST-5

6"  
(430232) \_\_\_\_\_ ST-6

pk 6



**4" SCRIPT STYLE 3-D NUMBERS**

**HY-KO PRODUCTS**

Plastic, raised numbers. Durable and weatherproof. Carded with mounting nails.

1  
(430321) \_\_\_\_\_ PN-29-1

2  
(430322) \_\_\_\_\_ PN-29-2

3  
(430323) \_\_\_\_\_ PN-29-3

4  
(430324) \_\_\_\_\_ PN-29-4

5  
(430325) \_\_\_\_\_ PN-29-5

6  
(430326) \_\_\_\_\_ PN-29-6

7  
(430327) \_\_\_\_\_ PN-29-7

8  
(430328) \_\_\_\_\_ PN-29-8

9  
(430329) \_\_\_\_\_ PN-29-9

0  
(430330) \_\_\_\_\_ PN-29-0

pk 10



BUILDERS HARDWARE

**4" SOLID BRASS NUMBERS NATIONAL**

Hand polished brass.

One per card.



**3" COLONIAL HAMMERED HOUSE NUMBERS**

HY-KO

Die cast. Ebony black.

Carded with nails.



Item	Pack	Part #	HDI #
<b>Brass - 4"</b>			
1	5	N211-599	405401
2	5	N211-607	405402
3	5	N211-615	405403
4	5	N211-623	405404
5	5	N211-631	405405
6	5	N211-649	405406
7	5	N211-656	405407
8	5	N211-664	405408
9	5	N211-672	405409
0	5	N211-581	405400

Item	Pack	Part #	HDI #
<b>Ebony Black - 3"</b>			
0	10	DC-3/0	485315
1	10	DC-3/1	485316
2	10	DC-3/2	485317
3	10	DC-3/3	485318
4	10	DC-3/4	485319
5	10	DC-3/5	485320
6	10	DC-3/6	485321
7	10	DC-3/7	485322
8	10	DC-3/8	485323
9	10	DC-3/9	485324

**4" SOLID BLACK NUMBERS NATIONAL**

Black finish.

One per card.



Item	Pack	Part #	HDI #
<b>Black - 4"</b>			
1	5	N238-634	465961
2	5	N238-642	465962
3	5	N238-659	465963
4	5	N238-667	465964
5	5	N238-675	465965
6	5	N238-683	465966
7	5	N238-691	465967
8	5	N238-709	465968
9	5	N238-717	465969
0	5	N238-626	465950



BUILDERS HARDWARE



**JUMBO PLASTIC SIGN  
15 X 19"**

HY-KO

Weatherproof. Greater visibility. All purpose. Bright fluorescent letters on a black background.

**For Sale**

(430198) \_\_\_\_\_ SP-100

**For Sale By Owner**

(430194) \_\_\_\_\_ SP-101

**For Rent**

(430201) \_\_\_\_\_ SP-102

**Yes We're Open**

(430190) \_\_\_\_\_ SP-108

**Sorry We're Closed**

(430195) \_\_\_\_\_ SP-109

**Garage Sale**

(430196) \_\_\_\_\_ SP-110

**House For Sale**

(430189) \_\_\_\_\_ SP-103

**Auto For Sale**

(430193) \_\_\_\_\_ SP-112

pk 5



**POSTED SIGN ROLL  
12 X 12" (LEGAL)**

HY-KO

Tyvek polyurethane fiber, not affected by water. Durable, weatherproof, inexpensive. 100 perforated signs per roll. Black letters on yellow background.

**Posted Private Property**

(430203) \_\_\_\_\_ TSR-100

pk 1



**HEAVY DUTY PLASTIC  
SIGN 11 X 11"**

HY-KO

Yellow background with black letters. Durable, weatherproof.

**Private Property**

(430200) \_\_\_\_\_ YP-1

pk 20



**PLASTIC SIGN  
10 X 14"**

HY-KO

Neon Signs

**For Sale Sign**

(430234) \_\_\_\_\_ 22103

**Auto For Sale Sign**

(430236) \_\_\_\_\_ 22104

pk 10



**ALUMINUM SIGN**

10 X 14"

HY-KO

Red letters on white background. Rounded corners. Prepunched holes.

**No Trespassing**

(430206) \_\_\_\_\_ SS-5

pk 12



**PLASTIC LAWN SIGN  
20 X 24"**

HY-KO

Two sided sign made from heavy corrugated plastic. Comes with frame. Black letters on white background.

**For Sale By Owner**

(430197) \_\_\_\_\_ LFS-1

**Garage Sale**

(430212) \_\_\_\_\_ LGS-2

pk 5



BUILDERS HARDWARE



TRAFFIC SIGNS

HY-KO

Item	Pack	Part #	HDI #
12" x 18" Aluminum. Bright, bold colors for maximum visibility. Extremely durable. Pre-punched mounting holes.			
No Parking	1	HW-1	430019
Handicapped Parking	1	HW-13	430021



911 REFLECTIVE ADDRESS PLATE

HY-KO

Item	Pack	Part #	HDI #
Pre-drilled, can be attached horizontally or vertically. 44-3" house numbers included.			
	5	911	430395



10" X 14" ALUMINUM SIGNS

HY-KO

Item	Pack	Part #	HDI #
Weather-resistant. Bright, bold colors for high visibility. Pre-punched mounting holes for easy installation. Rounded corners for finished look.			
For Sale	12	801	430003
No Trespassing	12	804	430005
No Hunting	12	806	430006
Keep Out	12	807	430007
Posted No Hunting	12	812	430009
Posted No Trespassing	12	813	430011
Open/Closed	12	820	430013
Private Property No Trespassing	12	848	430017



10" x 24" CORRUGATED PLASTIC SIGNS

HY-KO

Item	Pack	Part #	HDI #
Lawn Signs. Weather resistant. Double sided. Individually packaged in polybag with one 24" (H) steel mounting bracket.			
House For Sale	5	RS-801	430026
For Sale By Owner	5	RS-802	430028
Open House	5	RS-803	430030
Garage Sale	5	RS-804	430032



BUILDERS HARDWARE

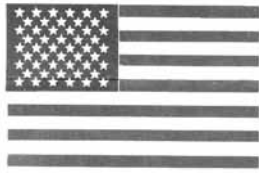

**USA FLAGS - FULL SIZE**  
HEATH

Full size bright poly knit printed  
AMERICAN FLAGS.

3 x 5' Header with grommets  
(500201) 25404  
pk 6



**FIXED BRACKET**  
HEATH  
Made in USA.

For 3/4" poles - White 63609  
(500240) 25092  
For 1" poles - White 63675  
(500235) 25093  
pk 12



**USA FLAG SET**  
HEATH

Deluxe Quality 5 Foot Decorative Flag  
Kit. Includes Wood Finial, 2-1/2 -by-4  
Feet Poly/Cotton U.S. Flag, 2 position  
Bracket, Mounting Hardware, and  
Anti-furling Tube.

(500210) 25169  
pk 12



**FLAG POLE**  
HEATH

Made in USA. 60" x 1" wood  
pole with sleeve and rope.

60" x 1" 63605  
(500230) 25108  
pk 4



**USA FLAG SET**  
HEATH

Includes a 3' x 5' US woven polyester  
flag plus a 6' 2-section durable tin  
plated pole. Rich colors with all-dyed  
design. Stamped steel bracket and  
hardware, halyard, 5" molded plastic  
eagle ornament. Strong white heading  
with brass grommets.

(500206) 25129  
pk 12



BUILDERS HARDWARE

9" X 12" PLASTIC SIGN  
KY-KO

Brightly Visible. Weatherproof.  
Brilliant fluorescent letter on a  
black background.



Apartment for Rent  
(430161) 3001

Beware of Dog  
(430162) 3002

Exit  
(430163) 3003

For Rent  
(430164) 3005

For Sale  
(430165) 3006

Garage Sale  
(430167) 3023

House For Sale  
(430168) 3004

Keep Off the Grass  
(430169) 3022

Keep Out  
(430171) 3010  
pk 10

No Dumping  
(430172) 3027

No Hunting  
(430173) 3021

Private Property - No Trespassing  
(430188) 3025

No Hunting or Trespassing  
(430174) 3011

No Hunting without Permission  
(430175) 3024

No Parking  
(430176) 3012

No Smoking  
(430177) 3013

No Trespassing  
(430178) 3014

Wet Paint  
(430184) 3032  
pk 10

Private Drive  
(430179) 3028

Private Property - Keep Out  
(430187) 3016

Sorry We're Closed  
(430180) 3018

Yes We're Open  
(430182) 3020

For Sale By Owner  
(430185) 3007

Yard Sale  
(430186) 3033

Store Hours  
(430191) 3030

Auto For Sale  
(430192) 3031

Help Wanted  
(430170) 3034  
pk 10





BUILDERS HARDWARE



DM80048 DM80054 DM100R-48 09-001  
DRIVEWAY MARKERS

HY-KO

Item	Pack	Part #	HDI #
Fiberglass Safety Marker - Made from durable fiberglass. 4 1/2" reflective tape is wrapped around each marker. Visible at all angles.			
Orange	36	DM80048	430145
<b>54" Heavy-Duty Safety Marker</b> - 1/2" diameter fiberglass reinforced rod. Wrapped in 8" reflective tape. Capped making it easy to pound into the ground.			
Orange	12	DM80054	430147
<b>Standard Aluminum Driveway Marker</b> - 48" twisted, aircraft grade aluminum rods. Rustproof, strong. 3" round two sided reflector.			
Red	24	DM100R-48	430150
Blue	24	DM100B-48	430151

REBOUND

Item	Pack	Part #	HDI #
Rebound Driveway Markers - Rebounds if hit by car or snow plow. 8" spike keeps marker in place all season. Flexible fiberglass rod & stainless steel spring.			
4' Orange	50	09-001	430135
<b>Basic Fiberglass Driveway Markers</b>			
4' Orange	200	10-001	430137
6' Tall Orange - Bulk	1	11-001	430140



MARKER MOUNT PLASTIC SPIKES

REBOUND DRIVEWAY MARKERS

Item	Pack	Part #	HDI #
Keeps markers upright all season long. Generous 2" strike area makes it easy to install. Works with all fiberglass markers 1/4" or 5/16" diameter. Guaranteed not to break when hammered. Reusable.			
6 per pack	24	14-024-06	430141



SLOW MOVING VEHICLE EMBLEMS

HY-KO

Item	Pack	Part #	HDI #
Aluminum. Highly reflective for top visibility day and night. Certified - meets federal and state requirements.			
	12	TA-1	430199



TAKE ONE TUBES

HY-KO

Item	Pack	Part #	HDI #
3" x 12" tube. Attaches to For Sales signs. Holds home sellers info sheets.			
	6	22130	430024



BRACKETED REFLECTOR

HY-KO

Item	Pack	Part #	HDI #
3 1/4" round reflector mounted in rugged unbreakable molded plastic brackets. Attach with screws, nails, or both. S.A.E. approved. Display carton.			
Red	24	DRF-3	430155
Amber	24	DAR-3	430160



BUILDERS HARDWARE



**RUBBER TIPS  
SHEPHERD**

Non-skid for hard floors. Use on tubular metal or wood furniture, angled or straight legs.  
24 per poly bag

**Black**

1/2" ID	T-16
(85420)	9758
5/8" ID	T-17
(85422)	9759
3/4" ID	T-18
(85424)	9760
7/8" ID	T-19
(85426)	9761
1" ID	T-20
(85428)	9762
1 1/8" ID	T-21
(85430)	9763
1 1/4" ID	T-22
(85432)	9746

pk 24

**White**

1/2" ID	T-16A
(85434)	9751
5/8" ID	T-17A
(85436)	9752
3/4" ID	T-18A
(85438)	9753
7/8" ID	T-19A
(85440)	9754
1" ID	T-20A
(85442)	9755
1 1/8" ID	T-21A
(85444)	9756
1 1/4" ID	T-22A
(85446)	9743

pk 24



**SWIVEL NAIL-ON GLIDES  
SHEPHERD**

For wooden legs.  
Brass plated. Non-rust white plastic base.  
4 per card

1 1/4"	
(400265)	9098
pk 6	



**CUSHION NAIL-ON  
GLIDES  
SHEPHERD**

For wooden legs. Non-rust nickel base.  
4 per card

**Rubber**

7/8"	
(400270)	9099
1 1/16"	
(400275)	9100
1 1/4"	
(400280)	9101
pk 6	

**Nylon**

5/8"	
(400295)	9445
3/4"	
(400300)	9446
7/8"	
(400305)	9447
1 1/8"	
(400310)	9448
pk 6	



**PLASTIC BASE TACK  
GLIDE  
SHEPHERD**

For wooden legs  
Non-rust white plastic base  
4 per card

7/8"	
(400285)	9102
pk 6	



BUILDERS HARDWARE



**CARPET BASE NAIL-ON GLIDE SHEPHERD**

For wooden legs on hard surface floors. Not for use on chair legs. 4 per card

1"  
(400290) 9103  
pk 6



**RUBBER CASTER CUP SHEPHERD**

Round  
Brown  
Prevent furniture leg dents in carpets and floors. 4 per card

2"  
(85102) 9077  
pk 24

1 9/16"  
(85104) 9075  
pk 6



**1 1/4" LIGHT DUTY SWIVEL BEARING FURNITURE CASTER SHEPHERD**

Plastic wheel for use on carpets and hard floors. Mounting height approx 1 7/8"  
4 per card  
50# per caster load rating.

Plate  
(400035) 9052

Stem  
(400025) 9053  
pk 6



**RUBBER CASTER CUP SHEPHERD**

Square  
Brown  
Cushioned rubber cups for use on hard floors. Prevent furniture leg dents in carpets and floors. 4 per card

1 5/8"  
(400405) 9074

2"  
(400400) 9076  
pk 6



**1 5/8" LIGHT DUTY SWIVEL BEARING FURNITURE CASTER SHEPHERD**

Plastic wheel for use on carpets and hard floors. Mounting height approx 2 1/2".  
4 per card  
60# per caster load rating

Plate  
(400040) 9054

Stem  
(400030) 9055  
pk 6



BUILDERS HARDWARE

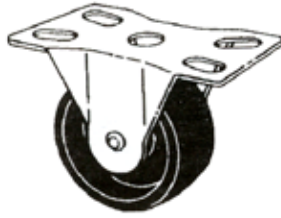

**MEDIUM DUTY  
POLYOLEFIN WHEEL  
RIGID CASTER  
SHEPHERD**

Zinc plated finish. Lightweight, non-marking wheels impervious to water and with good chemical resistance. Long wearing and low in cost. [capacity each caster]

2" [125#]  
(400336) 9396  
pk 36



**MEDIUM DUTY  
POLYOLEFIN WHEEL  
SWIVEL CASTER  
SHEPHERD**

Zinc plated finish. Lightweight, non-marking wheels impervious to water and good chemical resistance. Long wearing and low cost. [capacity each caster]

2" [125#]  
(400325) 9392  
pk 36

2½" [175#]  
(400330) 9393  
pk 12

3" [210#]  
(400335) 9394  
pk 8



BUILDERS HARDWARE



**MEDIUM DUTY SEMI-STEEL WHEEL SWIVEL CASTER SHEPHERD**

Zinc plated finish  
Exceptionally long wear life. Can withstand temperature extremes. Recommended for infrequently moved objects on rough wood and concrete floors where surface protection is not important.

2" 125#  
(400055) 9174  
pk 12



**MEDIUM DUTY RUBBER WHEEL RIGID CASTER SHEPHERD**

Zinc plated finish  
Soft rubber wheels give mobility to heavy load on smooth hard surfaces and finished concrete floors where quiet movement and maximum floor protection is needed.

2" 125#  
(400085) 9481  
pk 16

3" 210#  
(400095) 9483

4" 255#  
(400100) 9484  
pk 8



**MEDIUM DUTY RUBBER WHEEL SWIVEL CASTER SHEPHERD**

Zinc plated finish  
Soft rubber wheels give mobility to heavy load on smooth hard surfaces and finished concrete floors where quiet movement and maximum protection is needed.

2" 125#  
(400060) 9477  
pk 50

2" with brakes, 125#  
(400073) 9509

2½" 175#  
(400065) 9478  
pk 30

3" 210#  
(400070) 9479  
pk 20

4" 255#  
(400080) 9480  
pk 10



BUILDERS HARDWARE



**POLY TARP  
TEKTON**

**Silver**

8 x 10 weave per sq inch. UV shield coating. Resists damaging ultra violet rays for longer life. 2 layer reinforced laminated HD polyethylene fabric. Water, rot, mildew resistant. Reinforced corners and sealed in hems. Crack resistant to -20°F. Aluminum grommets on each corner and every 3 feet around hem.

6' x 8'  
(468010) 6290  
pk 40

8' x 10'  
(468020) 6295  
pk 25

9' x 12'  
(468060) 6300  
pk 20

10' x 12'  
(468030) 6315  
pk 18

10' x 20'  
(468070) 6325  
pk 10

12' x 16'  
(468040) 6330  
pk 12

16' x 20'  
(468050) 6350  
pk 8

20' x 20'  
(468075) 6375  
pk 5

20' x 30'  
(468080) 6380  
pk 3

20' x 40'  
(468085) 6385  
pk 2



**PLAST-O-MAT  
WARPS**

Ribbed floor runner and shelf liner. As floor runner it goes down quickly and lays flat. Ribs hold dirt until it can be wiped up or carried away. As shelf/drawer liner it is five times as thick as normal shelf liner. Won't tear, yet is easily cut to size. Not harmed by spills and wipes clean with damp cloth.

30" x 50'  
(480089) PM-50  
pk 1



BUILDERS HARDWARE

**POLY COVER SEAMLESS  
POLYETHYLENE  
SHEETING  
WARPS**

Guaranteed to be full weight and thickness. Each roll individually boxed with rigid core in every roll. Seals out moisture, wind and weather.



**2 MIL Clear**

8'4" x 200'  
 (480097) 2x84  
 20' x 200'  
 (480099) 2x20  
 pk 1

**4 MIL Clear**

3' x 100'  
 (480101) 4x3  
 4' x 100'  
 (480103) 4x4  
 6' x 100'  
 (480105) 4x6  
 8' x 100'  
 (480107) 4x8  
 10' x 100'  
 (480109) 4x10  
 12' x 100'  
 (480111) 4x12  
 14' x 100'  
 (480113) 4x14  
 16' x 100'  
 (480115) 4x16  
 20' x 100'  
 (480117) 4x20  
 24' x 100'  
 (480119) 4x24  
 pk 1

**6 MIL Clear**

12' x 100'  
 (480123) 6x12  
 16' x 100'  
 (480124) 6x16  
 20' x 100'  
 (480125) 6x20  
 pk 1

**4 MIL Black**

12' x 100'  
 (480127) 4x12-B  
 16' x 100'  
 (480129) 4x16-B  
 20' x 100'  
 (480131) 4x20-B  
 24' x 100'  
 (480133) 4x24-B  
 pk 1

**6 MIL Black**

12' x 100'  
 (480135) 6x12-B  
 24' x 100'  
 (480134) 6x24-B  
 28' x 100'  
 (480136) 6x28-B  
 32' x 100'  
 (480137) 6x32-B  
 40' x 100'  
 (480141) 6x40-B  
 pk 1  
 32' x 50'  
 (480139) 6Lx32-B  
 40' x 50'  
 (480143) 6Lx40-B  
 pk 1



BUILDERS HARDWARE

**POPULAR WEIGHT  
CARRYHOME COVERALL  
WARPS**

4 mil. Tough, for tear resistance and long life. Hundreds of uses.

Clear	
10 x 25'	
(480145)	12-4CH10
pk 12	
15 x 25'	
(480147)	4CH15
20 x 25'	
(480149)	4CH20
pk 4	
3 x 50'	
(480102)	4CH350
4 x 50'	
(480104)	4CH450
pk 6	
10 x 50'	
(480157)	4CH1050
15 x 50'	
(480159)	4CH1550
20 x 50'	
(480161)	4CH2050
pk 4	



Black	
10 x 25'	
(480165)	12-4CH10B
pk 12	
15 x 25'	
(480167)	4CH15B
20 x 25'	
(480169)	4CH20B
pk 4	
10 x 50'	
(480171)	4CH1050B
20 x 50'	
(480175)	4CH2050B
pk 4	

**HEAVY DUTY  
CARRYHOME COVERALL  
WARPS**

6 mil  
Super tough, resists abrasion. Use as vapor barrier under concrete, as a material cover outdoors, etc.

Clear	
10 x 25'	
(480151)	6CH10
15 x 25'	
(480153)	6CH15
20 x 25'	
(480155)	6CH20
pk 4	







BUILDERS HARDWARE



**NAIL-ON SINGLE WINDOW  
KIT  
WARPS**

2 mil  
36 x 72" Plastic sheet.  
Kit includes 18" water resistant  
molding, 35 nails.

(480051) \_\_\_\_\_ EZ36  
pk 36



**NAIL-ON TWO WINDOW  
KIT  
WARPS**

1 MIL  
Two 36 x 72" plastic sheets.  
Kit includes 36' water resistant  
molding, 70 nails.

(480053) \_\_\_\_\_ 2P24  
pk 24



**NAIL-ON DOOR KIT  
WARPS**

2 mil  
36 x 84" plastic sheet.  
Kit includes 21' water resistant molding,  
35 nails.

(480065) \_\_\_\_\_ ESD24  
pk 24



**TRANSPARENT TAPE  
W J DENNIS**

Clear, poly self adhesive tape. For  
weather-stripping and multi-purpose  
general use.

1" x 45'  
(55151) \_\_\_\_\_ 145  
2" x 25'  
(55153) \_\_\_\_\_ 225  
pk 24

2" x 100'  
(55155) \_\_\_\_\_ 2100  
pk 12



BUILDERS HARDWARE



**SHRINK IT BULK FILM WARPS**

Bulk shrink film for skylights and other unusual applications. No tape included.

64" x 25'  
(480092) SF-64-25  
pk 8



**SHRINK IT WINDOW SEALER KIT WARPS**

Insulates windows and seals out drafts. Crystal clear film shrinks tight with hair dryer. Kit includes 35' double face tape.

One window kit  
38 x 64"  
(480093) SK-38

54 x 84"  
(480095) SK-54  
pk 12



**DOUBLE FACE TAPE**

For inside installation of window materials. Transparent. Will not detract from room decor. Removes easily and will not harm molding when used as recommended. Double coated adhesive makes installation fast and easy.

**WJ Dennis**  
1/2" x 52' 2531  
(480063) 50699  
pk 24



BUILDERS HARDWARE

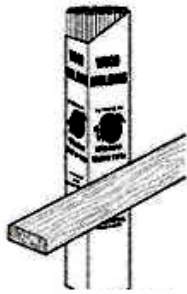

**WOOD MOULDING  
WARPS**

1/4 x 5/8" select pine. Flat with rounded edges.

**sold / price per carton only**

36" [250]  
(480071) SM-750  
pk 1

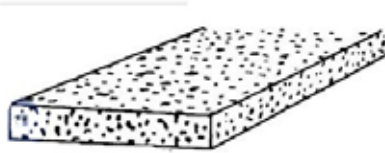

**FIBER MOULDING  
WARPS**

3/4". Water resistant strips for mounting plastic window material with tacks or staples.

**sold / price per pkg of 18**

36" [18 per pkg/ 25 per carton]  
(480075) FM1825  
pk 25

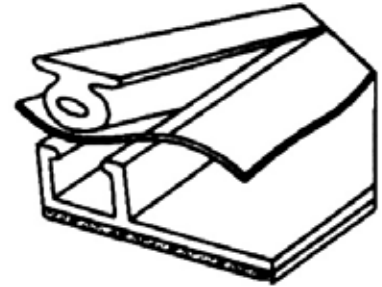

**FLEX-O-CHANNEL  
WARPS**

Two piece molding has adhesive to mount in place permanently. UV stabilized. Holds 1 to 4 mil film. White color. Paintable.

54"  
(480059) HCM-54W  
pk 50



BUILDERS HARDWARE

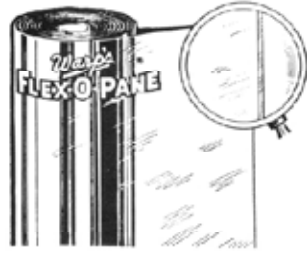

**FLEX-O-PANE  
WARPS**

Semi-rigid, ultra high clarity plastic. UV stabilized for years of service. For temperatures above 0°F.

5 mil  
 36" x 50 yd  
 (480013) \_\_\_\_\_ 5FP-3650

48" x 50 yd  
 (480011) \_\_\_\_\_ 5FP-4850  
 pk 1



**FLEX-O-GLASS  
WARPS**

Best quality window material. Crystal clear with no distortion. UV stabilized for years of service. For temperatures to -30°F.

36" x 25 yd  
 (480027) \_\_\_\_\_ NFG-3625

48" x 25 yd  
 (480023) \_\_\_\_\_ NFG-4825  
 pk 1



BUILDERS HARDWARE



**LINOLEUM BINDING**  
WJ DENNIS

Used for holding down linoleum or oil cloth. 3/4" x 12' aluminum.  
Poly Bag

(55157) 2700  
pk 24



**THRESHOLD**  
WJ DENNIS

36 1/2"L x 1 1/4"W x 1/2"H

Aluminum threshold with vinyl top insert. Poly bag with screws.

(55033) 150

Replacement Vinyl  
(55035) 150V  
pk 12



**THRESHOLD**  
WJ DENNIS

36 1/2"L x 3"W x 7/8"H

Low rug aluminum threshold with vinyl insert.  
Poly bag with screws

(55037) 200A

Replacement Insert  
(55039) TVR  
pk 12



BUILDERS HARDWARE

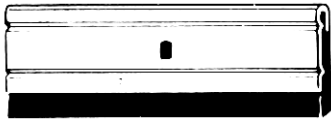

**DOOR SWEEP**  
W J DENNIS

Brass plated steel and felt.  
1 1/4"W x 36"L. Poly bag with screws.

(055023) 1373P  
pk 18

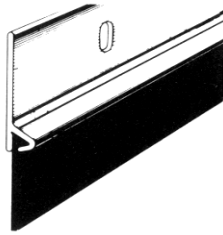

**DOOR SWEEP**  
W J DENNIS

Slotted aluminum and vinyl. 1 1/4"W x  
36"L. Poly bag with screws.

(055025) A54P  
pk 18

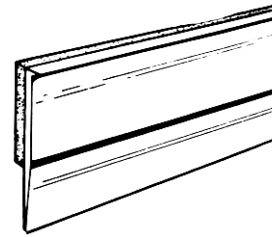

**SELF STICK DOOR SWEEP**

W J DENNIS

36"L Extruded white vinyl with flexible  
sweep. Easily installed on wood or  
metal doors. Poly bag.

(055032) 963  
pk 12

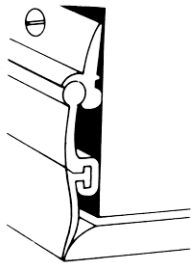

**FLIP SEAL AUTOMATIC DOOR BOTTOM**  
W J DENNIS

36"L Flexible vinyl strip locked in an  
aluminum frame. Automatically flips  
up to clear carpeting and threshold  
as door is opened. Seals from door  
bottom to floor or threshold. For  
inswinging doors.  
Poly bag with screws.

(055031) FS36AG  
pk 12

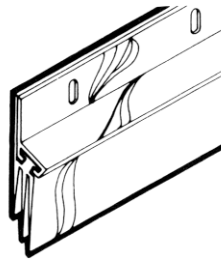

**DOOR SWEEP**  
W J DENNIS

Triple flanges. 36"L Anodized extrud-  
ed aluminum and heavy gauge triple  
flanged vinyl sweep provides barrier  
against drafts, dust, moisture and  
insects.  
Poly bag with screws

Gold Anodized  
(055027) 904

Satin Anodized  
(055028) 905  
pk 12



BUILDERS HARDWARE



**DOOR WEATHERSTRIP SET**  
W J DENNIS

Extruded aluminum with vinyl insert. For either wood or metal door jambs. Contains: 4 - 42", 1 - 36" length sheet metal drive nails. Set per poly bag

(055001) \_\_\_\_\_ 79V  
pk 12

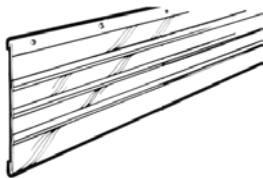

**BRONZE WEATHERSTRIP**  
W J DENNIS

For doors up to 3' x 7'. Made from hemmed spring bronze. 1-1/8"W x 17'L. Nails included. Poly bag.

(055005) \_\_\_\_\_ 4018  
pk 12

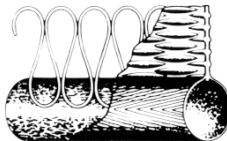

**INNER SEAL WEATHERSTIP**  
W J DENNIS

17' soft sponge rubber with neoprene & wire flange for tacking the strip into place. Spring wire flange automatically adjusts itself to tight or loose fitting doors or windows.

(055011) \_\_\_\_\_ BIS-17  
pk 12

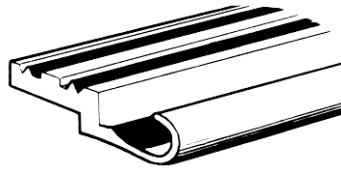

**DOOR WEATHERSTRIP SET**  
W J DENNIS

Vinyl extrusion combines rigid channels to trap air & pliable curl for effective sealing. Washable, requires no painting or maintenance. Consists of: 4 - 42", 1 - 36" length w/nails. Set per poly bag.

White  
(055002) \_\_\_\_\_ 4000  
pk 10

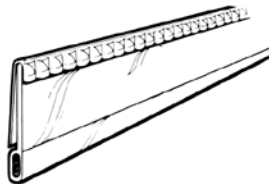

**TACK-ON WEATHERSTRIP**  
W J DENNIS

5/8" x 17'. Prepunched aluminum and vinyl. Serrated edge permits right angle turns without cutting. Poly bag with nails.

(055009) \_\_\_\_\_ 217-V  
pk 24



**DOOR WEATHERSTRIP SET**  
W J DENNIS

Closed cell vinyl foam bonded to ponderosa pine. Stops winds, drafts, sleet and snow. Contains: 2 - 84", 1 - 36" length with nails. Set per sleeve

(055003) \_\_\_\_\_ 81  
pk 15



**WEATHERSTIP NAILS**  
NATIONAL 7706

1.5 oz. per pack.  
Copper Finish

3/4" x 17  
(220411) \_\_\_\_\_ N278-036  
pk 5

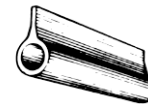

**TUBULAR WEATHERSTRIP**  
W J DENNIS

17' tubular vinyl. Use as a seasonal weatherstrip for unusual doors or windows.  
Gray

(055007) \_\_\_\_\_ ST-1  
pk 24



BUILDERS HARDWARE



**TIGHT FIT FOAM WEATHER STRIP**  
WJ DENNIS

Self adhesive open cell poly. Instant installation - just peel and press. Open cell foam compresses easily for snug fit. Great for sealing tight fitting doors or double hung windows. Hang up poly bag.

Charcoal 3/16" T x 3/8" W x 17' L (55073)	18-1
3/16" T x 3/4" W x 17' L (55075)	18-2
1/2" T x 3/4" W x 17' L (55077)	18-3
3/8" T x 1/2" W x 17' L (55079)	18-4

pk 24

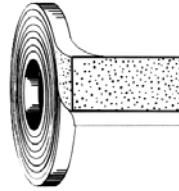

**HOME AND AUTO SUPER FIRM WEATHER STRIP**  
WJ DENNIS

Closed cell sponge rubber. Self adhesive - just peel and press. Resists UV, ozone, and weather. Cushions against rattles, shock, and vibrations. Excellent tensile strength and durability. Hang up poly bag.

Black 1/8" T x 3/8" W x 10' L (55083)	261
1/4" T x 3/8" W x 10' L (55087)	262
1/4" T x 3/4" W x 10' L (55091)	263
3/8" T x 3/8" W x 10' L (55092)	264
3/8" T x 3/4" W x 10' L (55093)	265
1/2" T x 1/2" W x 10' L (55096)	266

pk 24



**WIDE GAP FOAM WEATHER STRIP**  
WJ DENNIS

Self adhesive closed cell vinyl. Instant installation - just peel and press. Closed cell vinyl foam fills larger gaps. Resists moisture extremely well. Great for sealing air conditioners or loose fitting doors. Hang up poly bag.

Gray 1/8" T x 1/4" W x 17' L (55053)	FT18
<u>201</u>	
3/16" T x 3/8" W x 17' L (55055)	FT19
<u>202</u>	
1/4" T x 3/8" W x 17' L (55057)	FT20
<u>203</u>	
3/8" T x 1/2" W x 10' L (55059)	FT21
<u>204</u>	
3/8" T x 3/4" W x 10' L (55060)	FT22
<u>205</u>	
pk 24	
White 3/16" T x 3/8" W x 17' L (55223)	
<u>101</u>	
3/16" T x 3/8" W x 34' L (55227)	
<u>106</u>	
Brown 3/16" T x 3/8" W x 17' L (55229)	
<u>301</u>	
pk 24	





BUILDERS HARDWARE



**HEAVY DENSITY CLOSED CELL FOAM**  
WJ DENNIS

PREMIUM GRADE PVC. SELF ADHESIVE.

Charcoal  
1/4" T x 3/8" W x 17' L  
(55069) 213H

3/8" T x 3/4" W x 10' L  
(55071) 215H  
pk 24



**CAMPER MOUNT TAPE**  
WJ DENNIS

Self adhesive - wide gap - PVC foam tape that acts as a cushion and seal between truck and camper unit. Withstands all weather and temperatures. Seals out water, dust and noise.

Gray  
3/16" T x 1 1/4" W x 30' L  
(55061) 304

Closed cell sponge rubber. Super firm self adhesive.  
Black  
3/16" T x 1 1/4" W x 30' L  
(55098) 267  
pk 12



**PREMIUM WEATHER STRIP**  
WJ DENNIS

Self adhesive EPDM rubber. Ten times the efficiency of foam or felt weather strip. Ozone, UV and moisture resistant. Ribbed construction compresses to form an air tight seal. Protects to -40°F.

White  
3/16" T x 3/8" W x 17' L  
(55094) 502  
pk 24



**FELT WEATHER STRIP**  
WJ DENNIS

Seals out dust, dirt and insects. Insulates, cuts heating and cooling costs. Felt cushions and stops rattling around loose fitting doors and windows. Easy to apply - staple, tack or nail on.

3/16" T x 5/8" W x 17' L  
(55045) 65-17

3/16" T x 3/4" W x 25' L  
(55047) 6500  
pk 24



**ROPE CAULK**  
WJ DENNIS

Pliable denite rope caulk in easy to use rolls. Just peel and press to seal cracks. Requires no tools, guns, or tacks. Stores easily, no waste or mess. Won't crack or harden. Easily removed. Hang up box.

White  
45' roll 3/16" bead  
(55041) 216  
pk 20

90' roll 3/16" bead  
(55043) 219  
pk 12



BUILDERS HARDWARE

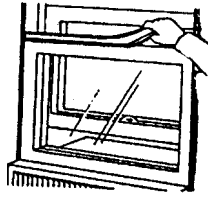

**AIR CONDITIONER FOAM SEAL**

W J DENNIS

Open cell poly foam. Great for sealing around air conditioners. Keeps cool air in during summer and prevents cold drafts in winter. Poly foam cushions and dampens vibrations. Removable and reusable.

Charcoal  
1 1/4" T x 1 1/4" W x 42" L  
(55095) \_\_\_\_\_ 19  
pk 24



**ELECTRICAL OUTLET & SWITCH INSULATORS**

W J Dennis

Closed cell foam insulation seals are pre-cut to fit around switches and receptacles. Heat loss and air conditioning leakages are prevented. U L Listed materials. Includes 8 outlet and 4 switch seals.

White  
Switch - Receptacle  
(55049) \_\_\_\_\_ 12RS

Decor switch - receptacle  
(55050) \_\_\_\_\_ 8per pk 8RKR  
pk 24

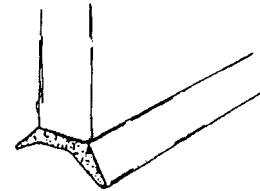

**GARAGE DOOR BOTTOM**

WJ DENNIS

HEAVY DUTY FLEXIBLE RUBBER SEAL MADE FOR BOTTOM OF OVERHEAD DOORS. SEALS RUN OUT RAIN, SNOW, DRAFTS AND DUST. ABSORBS SHOCK. INSTALL BY NAILING TO BOTTOM OF DOOR.

9'  
(55097) \_\_\_\_\_ 910-9  
pk 6

16'  
(55099) \_\_\_\_\_ 916-16  
pk 3



BUILDERS HARDWARE

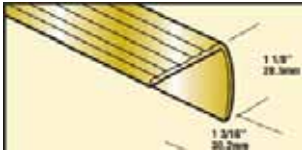

**STAIR NOSING**

**WJ DENNIS**

For carpet, tile, or linoleum. Can be applied to wood or cement stairs. Nosing is fastened down after covering has been laid. Made from aluminum.

3' x 1 1/8"  
Silver

(785266) TA73003

Gold  
(785267) TA72003

6' x 1 1/8"  
Silver

(785269) TA73006

Gold  
(785270) TA72006  
pk 6



**BEVELED JOINER TRIM**

**WJ DENNIS**

Keeps carpet, tile, linoleum tacked down. No ripples, rising or frayed edges. Made from aluminum.

1"

3'  
Silver  
(785276) TA63003

Gold  
(785277) TA62003  
pk 6

6'  
Hammered aluminum  
(785279) 2905

Gold  
(785280) TA62006  
pk 6

1 1/2"

3'  
Silver  
(785284) TA63103

Gold  
(785285) TA62103  
pk 6

6'  
Silver  
(785287) TA63106

Gold  
(785288) TA62106  
pk 6

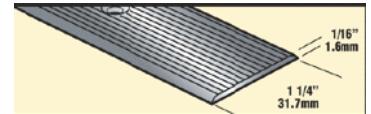

**1/4" FLAT JOINER TRIM**

**WJ DENNIS**

For carpet, tile and linoleum. Designed to fill the gap under an interior or exterior door.

Made from aluminum.

3' x 1/4"  
Silver  
(785243) TA23103

Gold  
(785254) TA22103

6' x 1/4"  
Silver  
(785246) TA23106

Gold  
(785257) TA22106  
pk 6



**CARPET CLAMP DOWN**

**WJ DENNIS**

Tackless.

With pins. Holds carpet snugly. No ripples or rising edges.

Use on wood or concrete floors.

6'  
Ridgid gold  
(785300) 63065  
pk 6



BUILDERS HARDWARE

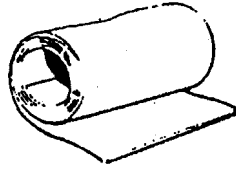

**ALUMINUM ROLL  
VALLEY & FLASHING  
STEELWORKS**

Used as a roll valley and flashing, in duct work & many other sheet metal applications. Easy to cut, roll or bend. 30 ga .010 thickness

MILL FINISH

50'		
10"	(63543)	
(785205)		1452
pk 4		
14"		
(785210)		6552S
20"	(63573)	
(785215)		1428
pk 1		
10'		
10"		
(785200)		66310
14"		
(785201)		06732
20"		
(785202)		06738
pk 1		

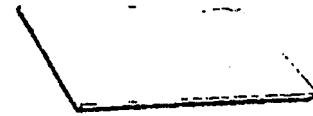

**GALVANIZED FLAT  
METAL SHEET  
JONES MFG**

26 ga  
Easy to form, punch or fasten for various applications.

24 x 30"  
(245300)  
pk 1



**BUILDERS HARDWARE**



**36" HARDWOOD DOWELS  
WADDELL**

Unfinished ramin wood, color coded for easy identification.

1/8" Black  
(55192) \_\_\_\_\_ 6302  
pk 25

3/16" Gray  
(55193) \_\_\_\_\_ 6303  
pk 25

1/4" Light Green  
(55195) \_\_\_\_\_ 6304  
pk 25

5/16" Red  
(55197) \_\_\_\_\_ 6305  
pk 25

3/8"  
(55199) \_\_\_\_\_ 6306  
pk 20

7/16" Jade Green  
(55201) \_\_\_\_\_ 6307  
pk 20

1/2" White  
(55203) \_\_\_\_\_ 6308  
pk 20

5/8" Brown  
(55205) \_\_\_\_\_ 6310  
pk 15

3/4" Yellow  
(55207) \_\_\_\_\_ 6312  
pk 8

7/8" Purple  
(55209) \_\_\_\_\_ 6314  
pk 6

1" Orange  
(55211) \_\_\_\_\_ 6316  
pk 6

1-1/8" Pink  
(55212) \_\_\_\_\_ 6318  
pk 4

1 1/4" Green  
(55214) \_\_\_\_\_ 6320  
pk 4



**PINEWOOD SHIMS  
NELSON**

1/16" x 5/16" x 8"  
Use for shimming cabinets, setting door jambs and windows, leveling appliances, furring strips, spreading adhesives, cleaning gutters. Sold by pack of 12 shims.

(496000) \_\_\_\_\_ PSH8/12  
case = 36 pk



BUILDERS HARDWARE

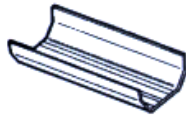

VINYL GUTTER

GENOVA RAINGO

Item	Pack	Part #	HDI #
5" plain end gutter has ridges to resist clogging by ice or debris. Supplies in 10' length			
White	10	RW100	60500
Brown	10	RB100	60610



VINYL GUTTER FITTINGS

GENOVA RAINGO

Item	Pack	Part #	HDI #
<b>Inside End Cap</b> - Used with a gutter fitting to make a gutter end either right or left.			
White	5	RW101	60505
Brown	5	RB101	60615
<b>Outside End Cap</b> - Used to make a gutter end either right or left. With Raingo seals			
White	10	RW102	60510
Brown	10	RB102	60620
<b>Corner</b> - Used for either inside or outside 90° corner. Support fitting with seals and fitting marks indicates the corner gutter placement to give required expansion allowance.			
White	5	RW103	60515
Brown	5	RB103	60625
<b>Drop Outlet</b> - Used to connect gutter with downspout. Support fitting with seals and fitting marks indicates the correct placing of gutter to give required expansion allowance.			
White	5	RW104	60520
Brown	5	RB104	60630
<b>High Flow Drop Outlet</b> - Highflow outlet increases the gutter capacity and discharge rate of rainwater.			
White	5	HRW107	60535

HRW107

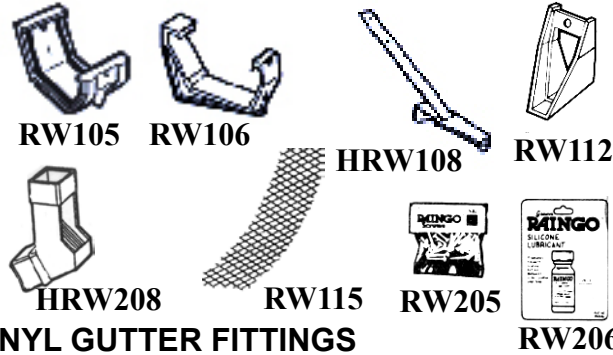

VINYL GUTTER FITTINGS

GENOVA RAINGO

Item	Pack	Part #	HDI #
<b>Slip Joint</b> - Used to join two pieces of gutter. Support fitting with seals and fitting marks for correct placing.			
White	10	RW105	60525
Brown	10	RB105	60635
<b>Bracket</b> - Used for support of gutter. Recommended installation every 30" where fittings are not used.			
White	25	RW106	60530
Brown	25	RB106	60640
<b>Strap Hanger</b> - Used where fascia board does not exist or is not vertical. Attaches to roof under shingles. Connects to support brackets and slip joints with screws.			
	50	HRW108	60540
<b>Bracket Spacer</b> - Designed to compensate for the slope in roofs constructed with non-vertical fascia or no fascia. <b>Sold/price per pkg of 5</b>			
White	6	RW112	60550
Brown	6	RB112	60650
<b>Leafgo Debris Separator</b> - Helps prevent leaves from clogging gutters. This part is a patented feature exclusive to the Raingo® system.			
Brown	5	HRB208	60680
<b>Gutter Guard</b> - 5' length. For use with any symmetrical gutter system to prevent leaves and other debris from entering the gutter system. Non-metallic			
White	20	RW115	60552
<b>Rust-Resistant Screws</b> - Used for mounting brackets and fittings. <b>Sold/Price per pack of 25</b>			
	10	RW205	60580
<b>All Purpose Seal Lubricant</b> - Used as a lubricant for neoprene seals found on Raingo gutter fittings to ease installation. 1 oz.			
	10	RW206	60585



BUILDERS HARDWARE

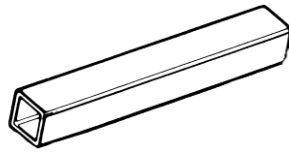

VINYL DOWNSPOUTS

GENOVA RAINGO

Item	Pack	Part #	HDI #
2½" square. Supplied in 10' length.			
White	10	RW200	60555
Brown	10	RB200	60655



VINYL DOWNSPOUT FITTINGS

GENOVA RAINGO

Item	Pack	Part #	HDI #
<b>Standard Elbow</b> - Used where downspout changes in any direction. Turns 112° for offsets and discharge spouts.			
White	10	RW201	60560
Brown	10	RB201	60660
<b>90° Elbow</b> - Used where downspout changes in any direction. Turns 92½° for offsets and discharge spouts.			
White	10	RW209	60595
Brown	10	RB209	60685
<b>Bracket</b> - Used to support downspout at either the offset elbow, coupler or discharge spout.			
White	25	RW202	60565
Brown	25	RB202	60665
<b>Coupler</b> - Used in joining two lengths of downspout.			
White	5	RW203	60570
Brown	5	RB203	60670
<b>Adapter</b> - Adapts Raingo downspout 4" plastic sewer pipe or sch 40 dwv fittings.			
White	5	RW207	60590
Brown	5	RB207	60675



DRIP EDGE

GENOVA RAINGO

Item	Pack	Part #	HDI #
10' length. Slips under shingles on roofs that do not have sufficient overhang.			
Brown	25	19564	60695



FLEX-DRAIN LANDSCAPING DRAIN PIPE

CLEVELAND TUBING

Item	Pack	Part #	HDI #
Now you can create the perfect French Drain or flexible Downspout Extension so you can move standing water away from your house or divert collecting water away from your garden. FLEX-Drain® Landscape Drain Pipe can easily bend around objects and expands and contracts as you need it to, giving you just the right amount of drain pipe for all your residential water draining projects!			
<b>Pipe</b>			
4" 50' Solid	1	52001	488065
4" 50' Perforated	1	52002	488060
4" 50' Perforated w/Sock	1	52003	488070
4" 50010 25' Solid Pipe	6	50110	488005
4" 50120 25' Perforated	6	50310	488010
4" 50125 25" Perforated w/Sock	6	50510	488015
4" 50600 12' Solid	12	50710	488020
4" 50080 12" Perforated	12	50910	488025
<b>Fittings</b>			
4" 55000 Coupler	20	55020	488030
4" 57000 Connector	10	57010	488035
53200 Downspout Adapter 2 x 3 x 4	10	53202	488040
53100 Downspout Adapter 3 x 4 x 4	10	53102	488045
4" 53500 Flexible Elbow	10	53502	488050
4" 53300 ID to ID Connector	16	53202	488055



**PLANT HARDWARE ACCESSORIES**

NATIONAL **SWL: Safe Working Load**

Item	Pack	Part #	HDI #
<b>V2660 Plant Extender Chain Kits - White Finish, 1 per card</b>			
36" 12 lb. SWL	5	N275-073	230792
<b>V2661 Extender Plant Kits - 1 per card</b>			
18" Black Finish 15 lb. SWL	3	N275-081	230774
18" White Finish 15 lb. SWL	3	N275-115	230759
<b>V2665 Plant Extension Hook Kits - 1 per card</b>			
3½" Black Finish 12 lb. SWL	5	N275-149	230782
3½" Brass Finish 12 lb. SWL	5	N275-123	230793
3½" White Finish 12 lb. SWL	5	N275-131	230781
6" Black Finish 15 lb. SWL	5	N275-180	230783
6" Brass Finish 15 lb. SWL	5	N275-172	230794
6" White Finish 15 lb. SWL	5	N275-164	230784
<b>V2666 Plant Ceiling Hooks</b>			
<b>3 per card</b>			
2½" Black Finish 25 lb. SWL	5	N274-944	230778
2½" Brass Finish 25 lb. SWL	5	N274-936	230795
2½" White Finish 25 lb. SWL	5	N274-928	230777
<b>1 per card</b>			
6" White Finish 25 lb. SWL	5	N275-206	230780
<b>V2667 Plant Vinyl Coated Outdoor Hooks - 2 per card</b>			
1½" White Vinyl 15 lb. SWL	5	N274-951	230762
<b>V2668 Plant Extender S-Hooks - 1 per card</b>			
12" Black Finish 12 lb. SWL	5	N275-222	230786
12" Brass Finish 12 lb. SWL	5	N275-248	230797
12" White Finish 12 lb. SWL	5	N275-230	230785
<b>V2669 Plant Suspended Ceiling Hook - 2 per card</b>			
2" White Finish 10 lb. SWL	5	N274-969	230761
<b>V2670P Plant Ceiling Track Hooks - 2 per card</b> Snap-on			
Clear 10 lb. SWL	5	N275-156	230787

**PLANT HARDWARE ACCESSORIES**

NATIONAL **SWL: Safe Working Load**

Item	Pack	Part #	HDI #
<b>V2671 Plant Swag Hooks - 2 per card</b>			
1½" Antique Brass 30 lb. SWL	5	N274-811	230767
1½" Black Finish 30 lb. SWL	5	N274-829	230768
1½" White Finish 30 lb. SWL	5	N274-845	230754
<b>V2672 Plant Swag Hooks - 1 per card</b>			
2¼" Antique Brass 30 lb. SWL	5	N274-852	230765
2¼" Black Finish 30 lb. SWL	5	N274-860	230769
2¼" White Finish 30 lb. SWL	5	N274-878	230752
<b>V2673 Plant Swivel Swag Hooks - 1 per card</b>			
2" Antique Brass 30 lb. SWL	5	N274-894	230766
2" White Finish 30 lb. SWL	5	N274-910	230753

**CAMPBELL CHAIN**

Item	Pack	Part #	HDI #
<b>Swag Hooks - Two hooks and two toggle bolts per card.</b>			
Black 60 lb. SWL	10	B595 1590	410130
Antique Brass 60 lb. SWL	10	B595 1570	410135
White 60 lb. SWL	10	B595 1550	410140
Brass 60 lb. SWL	10	B595 1560	410145



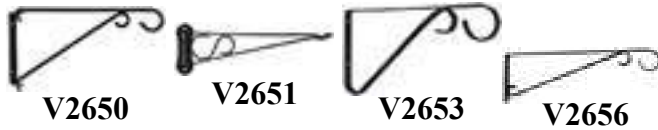

**HANGING PLANT BRACKETS**

NATIONAL **SWL: Safe Working Load**

Item	Pack	Part #	HDI #
<b>V2650 Plant Swivel Brackets - 1 per card</b>			
9" Black Finish 15 lb. SWL	3	N274-761	230772
9" White Finish 15 lb. SWL	3	N274-779	230758
<b>V2651 Plant Decorative Swivel Brackets - 1 per card</b>			
10" Black Finish 7 lb. SWL	3	N274-795	230771
10" White Finish 7 lb. SWL	3	N274-803	230757
<b>V2653 Plant Brackets - 1 per card</b>			
6" Black Finish 12 lb. SWL	3	N274-514	230770
6" White Finish 12 lb. SWL	3	N274-522	230755
9" Black Finish 15 lb. SWL	3	N274-563	230764
9" White Finish 15 lb. SWL	3	N274-571	230751
<b>V2656 Plant Bracket/Sign Holder - 1 per card</b>			
15" Black Finish 20 lb. SWL	3	N274-621	230763
15" White Finish 20 lb. SWL	3	N274-639	230750

**HINDLEY**

Item	Pack	Part #	HDI #
<b>Golden Brass Planter Hook - Poly bag w/screws.</b>			
22454 10"	10	1710BP	230335

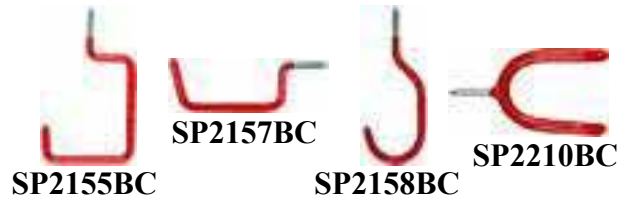

**STORAGE HOOKS**

NATIONAL **SWL: Safe Working Load**

Item	Pack	Part #	HDI #
<b>SP2155BC Large Storage Screw Hooks - Red Vinyl Coated Bulk</b>			
(N220-848) 3 1/2" 50 lb. SWL	40	N271-013	230346
<b>SP2157BC Ladder Hooks - Red Vinyl Coated Bulk</b>			
(N221-028) 6" 20 lb. SWL	40	N271-011	230347
<b>SP2158BC Bicycle Hooks - Red Vinyl Coated Bulk</b>			
(N221-036) 6 1/2" 60 lb. SWL	40	N271-015	230329
<b>SP2210BC Double Screw Hooks - Red Vinyl Coated Bulk</b>			
(N222-489) 2 7/8" 10 lb. SWL	40	N271-012	230345



BUILDERS HARDWARE



PEGBOARD HOOKS

NATIONAL **SWL: Safe Working Load**

Item	Pack	Part #	HDI #
<b>Light Duty</b>			
<b>V2300 Angle Hooks</b> - Zinc Plated. For 1/8 or 1/4" Pegboard.			
(N180-265) 7/8" - 10 per card	10	N180-004	455400
<b>V2301 Angle Hooks</b> - Zinc Plated. For 1/8 Pegboard.			
(N180-281) 1 1/2" - 8 per card	10	N180-003	455401
(N180-299) 2 1/2" - 6 per card	10	N180-005	455402
<b>V2305 Curved Hooks</b> - Zinc Plated. For 1/8 Pegboard			
(N180-323) 1/2" - 10 per card	10	N180-023	455403
(N180-331) 1" - 8 per card	10	N180-024	455404
<b>V2310 Single Hooks</b> - Zinc Plated. For 1/8 or 1/4 pegboard.			
(N180-380) 2" - 4 per card	5	N180-009	455405
(N180-398) 4" - 3 per card	5	N180-001	455406
(N180-406) 6" - 3 per card	5	N180-013	455407
<b>SP2310BC Single Hooks</b> - Zinc Plated. For 1/8 or 1/4 pegboard. <b>Bulk</b>			
(N235-101) 2"	100	N235-011	455305
(N235-119) 4"	50	N235-013	455290
(N235-127) 6"	50	N235-015	455295
(N235-135) 8"	50	N235-016	455300
<b>V2311 Double Hooks</b> - Galvanized Finish. For 1/8 or 1/4 Pegboard.			
(N180-448) 3" - 2 per card	5	N180-037	455408
(N180-455) 6" - 2 per card	5	N180-038	455409
<b>V2330 Multiple Tool Holders</b> - Galvanized Finish. For 1/8 or 1/4 pegboard. 9" Length			
(N180-869) 3/4" - 1 per card	5	N180-040	455410
<b>SP2330BC Multiple Tool Holders</b> - Galvanized Finish. For 1/8 or 1/4 pegboard. 9" Length <b>Bulk</b>			
(N235-218) 3/4"	20	N235-023	455315

PEGBOARD HOOKS

NATIONAL **SWL: Safe Working Load**

Item	Pack	Part #	HDI #
<b>V2333 Plier Holders</b> - Zinc Plated. For 1/8 or 1/4 peg-board.			
(N180-562) 1 1/2" - 3 per card	5	N180-030	455411
<b>V2349 Utility Hook Kits</b> - Zinc Plated. For 1/8 peg-board. Assortment of 26 hooks in various sizes.			
(N180-760)	5	N182-003	455412
<b>Heavy Duty</b>			
<b>V2351 Angle Hooks</b> - Zinc Plated. For 1/4 pegboard.			
(N180-612) 1 1/2" - 8 per card	10	N180-007	455413
<b>SP2351 Angle Hooks</b> - Zinc Plated. For 1/4 pegboard. <b>Bulk</b>			
(N180-620) 1 1/2"	200	N180-008	455395
<b>V2360 Single Hooks</b> - Zinc Plated. For 1/4 pegboard.			
(N180-679) 4" - 3 per card	5	N180-010	455415
(N181-362) 6" - 3 per card	5	N180-012	455416
<b>SP2360BC Single Hooks</b> - Zinc Plated. For 1/4 peg-board. <b>Bulk</b>			
(N235-234) 4"	50	N235-012	455365
(N235-242) 6"	50	N235-014	455370
(N235-259) 8"	40	N235-017	455375
<b>V2361 Double Hooks</b> - Galvanized Finish. For 1/4 peg-board.			
(N180-729) 3" - 2 per card	5	N180-036	455417
<b>SP2361BC Double Hooks</b> - Galvanized Finish. For 1/4 pegboard. <b>Bulk</b>			
(N235-275) 3"	30	N235-019	455355
(N234-732) 6"	30	N235-002	455350
<b>V2379 Garage Workshop Kits</b> - Zinc Plated. For 1/4 pegboards. Assortment of 20 hooks in various sizes.			
(N249-953)	5	N182-002	455418

DIVIDED DISPLAY BIN



GENOVA

Item	Pack	Part #	HDI #
This divided display bin is made of thermoplastic material and connects easily to your 1/4" pegboard displays.			
9" x 5" x 4 3/8"	10	265335	60160



BUILDERS HARDWARE



**CHAIN BINDER**  
CM/DIXIE INDUSTRIES

Forged lever. 1/4" maximum chain size. 3 3/4" take-up. 2600# working load limit. Free turning 360° swivels on both hooks for easier handling.

(575010) \_\_\_\_\_ 48304  
pk 4



**CHAIN BINDER**  
CM/DIXIE INDUSTRIES

Forged lever. 3/8" maximum chain size. 4 1/2" take up. 5400# working load limit. Free turning 360° swivels on both hooks for easier handling.

(575015) \_\_\_\_\_ 48305  
pk 4



**CHAIN BINDER**  
CM/DIXIE INDUSTRIES

Forged lever. 1/2" proof coil maximum chain size. 3/8" high test maximum chain size. 4 1/2" take up. 9200# work load limit. Free turning 360° swivels on both hooks for easier handling.

(575020) \_\_\_\_\_ 48306  
pk 4

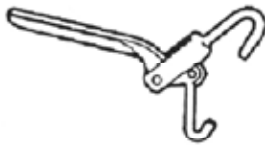

**CHAIN TIGHTENER**  
CM/DIXIE INDUSTRIES

Cast construction. 3" take-up. 400# work load limit. One hook swivels for easier operation.

(575005) \_\_\_\_\_ 48949  
pk 10



BUILDERS HARDWARE



**HIGH TEST CHAIN  
CAMPBELL CHAIN**

System 4  
For use in load binding, towing,  
logging, and other applications where  
high strength to weight ratio is re-  
quired.

Plated

**Not For Overhead Lifting**

High Test Work Load Limit

1/4"	2600#
5/16"	3900#
3/8"	5400#

Order by pail only

Pail

1/4" x 150'	
<u>(410021)</u>	<u>018-1423</u>
5/16" x 100'	
<u>(410022)</u>	<u>018-1523</u>
3/8" x 75'	
<u>(410023)</u>	<u>018-1623</u>
pk 1	

**ALL proof coil and high test  
chain sold by full pail or reel  
only. Orders for lesser  
quantities will not be  
accepted.**

**PROOF COIL CHAIN  
CAMPBELL CHAIN**

System 3

General purpose commercial  
quality chain for all ordinary  
uses where high strength to  
weight ratio is not required. For  
towing, binding, etc.

Plated

**Not For Overhead Lifting**

Proof Coil Work Load Limit

3/16"	750#
1/4"	1250#
5/16"	1900#
3/8"	2650#

Order by pail/reel only

**Pail**

3/16" x 250'	
<u>(410005)</u>	<u>014-0323</u>
1/4" x 141'	
<u>(410010)</u>	<u>014-0423</u>
5/16" x 92'	
<u>(410015)</u>	<u>014-0523</u>
3/8" x 63'	
<u>(410020)</u>	<u>014-0623</u>
pk 1	

**Refill Reel**

3/16" x 100'	
<u>(410025)</u>	<u>072-5027</u>
1/4" x 65'	
<u>(410030)</u>	<u>072-2127</u>
5/16" x 60'	
<u>(410035)</u>	<u>072-2227</u>
3/8" x 35'	
<u>(410040)</u>	<u>072-2327</u>
pk 1	



**Square Pail**

3/16" x 150'	
<u>(410001)</u>	<u>014-3326</u>
1/4" x 100'	
<u>(410002)</u>	<u>014-3426</u>
5/16" x 75'	
<u>(410003)</u>	<u>014-3526</u>
3/8" x 45'	
<u>(410004)</u>	<u>014-3626</u>
pk 1	



BUILDERS HARDWARE



**SASH CHAIN  
CAMPBELL CHAIN**

Flat metal chain for suspension of double hung sash, easily installed. Operates smoothly over pulleys. Suitable for many industrial assemblies.

#35 x 100' reel  
Zinc plated  
106# work load  
(410065) 072-3727  
pk 1



**SINGLE/DOUBLE  
JACK CHAIN**

**CAMPBELL CHAIN**  
Light duty chain for uses such as suspending flower pots, scales, and children's toys.

#16 x 250' reel - Single  
Zinc plated  
10# work load  
(410070) 072-4027

#14 x 190' reel - Single  
Black poly coated  
16# work load  
(410327) PB072-2827

#12 x 100' reel - Single  
Zinc plated  
29# work load  
(410042) 072-1727

#16 x 200' reel - Double  
Brass Glo  
(410125) 072-1667  
pk 1



**MACHINE CHAIN TWIST  
LINK**

**CAMPBELL CHAIN**  
Available in this style to make it more flexible. Also lies flatter. Work load limits somewhat less than straight link machine chain.

2/0 x 70' reel  
Zinc plated  
520# work load  
(410075) 072-2527  
pk 1



**LOCK LINK CHAIN  
CAMPBELL CHAIN**

Single loop. Used for operating sprocket wheels on overhead doors or valves. Can be made endless. Strongest of the weldless chains.

3/0 x 50' reel  
Zinc plated  
405# work load  
(410322) 072-2427

3/0 x 125' reel  
Zinc plated  
405# work load  
(410085) 072-3427  
pk 1



**BRASS SAFETY CHAIN  
CAMPBELL CHAIN**

Plumbers chain - stamped flat link chain widely used for attaching plumbing fixtures, pulley service and for general utility chain

1/0 x 200' reel  
Bright Brass  
35# work load  
(410080) 072-3817  
pk 1



**PLASTIC CHAIN  
CAMPBELL CHAIN**

Used for creating borders for flower beds, gardens, driveways, etc.

#8  
Square pail  
138'  
Yellow  
(410330) 099-0836  
White  
(410331) 099-0846  
pk 1



BUILDERS HARDWARE



**INCO [TWIN LOOP] CHAIN  
CAMPBELL CHAIN**

General utility chain for hardware and manufacturing applications such as playground and gym equipment, fluorescent lights, boats, gates, porch swings, dog runner, cow ties, etc.

#1 - 155# work load  
Zinc plated  
125' reel  
(410328) 072-2627  
250' reel  
(410045) 072-0127  
450' square pail  
(410320) 075-4126

#3 - 90# work load  
Zinc plated  
200' reel  
(410050) 072-3227

2/0 - 255# work load  
Zinc plated  
60' reel  
(410325) 072-2087  
155' reel  
(410055) 072-2027  
250' box  
(410060) 076-2024  
275' square pail  
(410329) 075-2426  
350' round pail  
(410052) 075-2023

2/0 - 255# work load  
Yellow poly coated  
200' square pail  
(410321) PD075-2496  
pk 1



**TWIST LINK COIL CHAIN  
CAMPBELL CHAIN**

Longer links than machine chain. Uses include animal tie chains, agriculture implement chains, platform barrier or guard chains, etc. Twist links lie flatter than straight link.

#3 x 50' reel  
Brass plated  
240 # work load  
(410044) 072-3167  
pk 1



**STRAIGHT LINK COIL  
CHAIN**

**CAMPBELL CHAIN**  
Longer links than machine chain. Uses include animal tie chains, agriculture implement chains, platform barrier or guard chains, etc.

520# work load  
2/0 x 40' reel  
Zinc plated  
(410324) 072-2827

2/0 x 125' reel  
(410090) 072-3627

2/0 x 225' square pail  
(410326) 033-2426

2/0 x 400' round pail  
(410062) 033-2023  
pk 1



**MACHINE  
CHAIN- STRAIGHT LINK  
CAMPBELL CHAIN**

Short link welded chain for general use where compactness and flexibility are desired.

#3 x 50' reel  
Brass Plated  
270# work load  
(410043) 072-3367  
pk 1

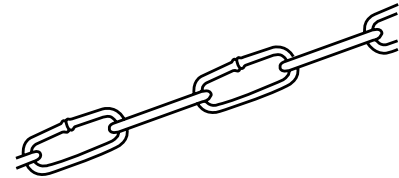

**HANDY LINK UTILITY  
CHAIN**

**CAMPBELL CHAIN**  
For hanging fixtures and plants, for animal ties, etc.

1.35 x 175' reel  
Zinc Plated  
340# work load  
(410041) 072-3169  
pk 1



**PASSING LINK CHAIN  
CAMPBELL CHAIN**

Wide design lets links pass freely minimizing kinks and tangling. Use for animal ties, farm machinery and general utility on farms or in industry,

2/0 x 50' reel  
Zinc Plated  
450# work load  
(410323) 072-2957  
pk 1



BUILDERS HARDWARE

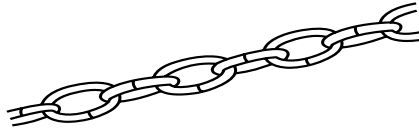

**DECORATOR CHAIN**

Campbell Chain  
For hanging plants, lamps etc.  
Also drapery tie-backs.

- #10 x 40'  
Work load not rated  
Antique Brass  
(410105) 072-2003
- Brass Glo  
(410115) 072-2000
- White  
(410110) 072-2004
- Black  
(410100) 072-2002
- Antique Copper  
(410095) 072-2006
- Antique Silver  
(410120) 072-2007  
pk 1



**TWIST HOBBY & CRAFT CHAIN**

Campbell Chain  
Various uses for small size chains

- #70 - 82'  
Brass Plated  
(410339) 071-7017  
pk 1
- #90 - 82'  
Nickel Plated  
(410348) 071-9027  
pk 1
- #200 - 49'  
Brass Plated  
(410347) 071-2017  
pk 1
- #250 - 33'  
Brass Plated  
(410349) 071-2517  
Black  
(410351) 071-2577  
pk 1



**SASH HOBBY & CRAFT CHAIN**

Campbell Chain  
Various uses for small size chains

- #2 - 164'  
Chrome Plated  
(410343) 071-0227
- #3 - 82'  
Chrome Plated  
(410346) 071-3027  
pk 1



**CLOCK HOBBY & CRAFT CHAIN**

Campbell Chain  
Various uses for small sizes

- Brass Plated  
#5 - 82'  
(410341) 071-0517
- #3 - 164'  
(410342) 071-0317
- #7 - 82'  
(410345) 071-0717  
pk 1



**BALL HOBBY & CRAFT CHAIN**

Campbell Chain  
Various uses for small size chains

- #36 - 164' Chrome Plated  
(410344) 071-3627  
pk 1



BUILDERS HARDWARE

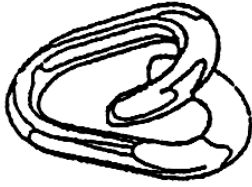

CHAIN REPAIR LINK - LAP LINK

SWL: Safe Working Load

BARON / NATIONAL

Item	Pack	Part #	HDI #
<b>3152BC</b> - For temporary use on proof coil and for use with couplings or other attachments. NOTE: <i>working load limit is far less than comparable chain size. When lap link is used for repair, the working load limit for the entire chain becomes that of the lap link.</i> Zinc plated.			
1/8 x 1 - 120 SWL	20	N223-065	415261
N223-073 3/16 x 1 225 SWL	100	660-3/16	410695
1/4 x 1-1/4 500 SWL	10	660-1/4	410710
N223-107 5/16 x 2 725 SWL	10	660-3/8	410720
N223-115 3/8 x 2 1450 SWL	50	660-3/8	410725



EYE SLIP HOOKS W/ LATCH

SWL: Safe Working Load

NATIONAL

Item	Pack	Part #	HDI #
<b>3247BC</b> - For use with common proof chain. blue finish.			
1/4" 2600 SWL	5	N265-504	410666
5/16" 3900 SWL	5	N265-512	410667



SWL: Safe Working Load

COLD SHUT

BARON / NATIONAL

Item	Pack	Part #	HDI #
The most inexpensive method of repairing or connecting chain. If sized, closed and riveted properly the cold shut is stronger than proof coil chain. Use one size <i>larger</i> than chain size. Zinc plated.			
N240-333 3/16"	25	383-3/16	410605
N240-341 1/4"	25	383-1/4	410610
5/16"	10	383-5/16	410615
N240-366 3/8"	25	383-3/8	410620
7/16"	10	383-7/16	410625
N240-382 1/2"	10	383-1/2	410630



CLEVIS SLIP HOOKS W/ LATCH

NATIONAL

Item	Pack	Part #	HDI #
<b>3243BC</b> - For use with common proof chain. blue finish.			
1/4" 2600 SWL	5	N265-470	410691
5/16" 3900 SWL	5	N265-488	410693
3/8" 5400 SWL	3	N265-495	410692
1/2" 9200 SWL	1	N282-061	410694





BUILDERS HARDWARE



CLEVIS GRAB HOOK

BARON

Item	Pack	Part #	HDI #
High Test. Clevis allows hook to be attached directly to chain without the use of a connecting link. Extra deep, narrow throat for nonslip holding.			
1/4"	5	330-1/4	410765
5/16"	5	330-5/16	410770
3/8"	3	330-3/8	410775
1/2"	1	330-1/2	410777



CLEVIS SLIP HOOK

BARON

Item	Pack	Part #	HDI #
High Test. Clevis allows hook to be attached directly to chain without the use of a connecting link. Most versatile chain hook due to their full wide throat design.			
For use with common proof coil.			
67193 - 1/4"	10	331-1/4	410780
5/16"	10	331-5/16	410785
3/8"	10	331-3/8	410790
7/16"	10	331-7/16	410685
66591 - 1/2"	10	331-1/2	410690



TRACTOR DRAW BAR HOOK

KOCH

Item	Pack	Part #	HDI #
Painted black			
5/16" x 1/2"	1	M834-4005903	410809



TRACTOR LYNCH PINS

DIXIE

Item	Pack	Part #	HDI #
Forged carbon steel for maximum strength. Spring steel snap rings. Zinc plated to resist rust.			
7/16"	150	65936	410825



CLEVIS PINS

NATIONAL

Item	Pack	Part #	HDI #
Replacements for clevis slip/grab hooks.			
1/4"	3	N245-928	410854
5/16"	3	N245-936	410855
3/8"	3	N245-944	410856
1/2"	3	N245-951	410857



CHAIN SWIVEL

NATIONAL

Item	Pack	Part #	HDI #
For chain or rope connecting lines. To permit turning or positioning of loads without tangling lines. Not for overhead lifting. Galvanized. [work load limit]			
3/16"	5	N247-775	410762
[850#] 363-0435 - 1/4"	5	N241-075	410750
[1250#] 363-0535 - 5/16"	5	N241-083	410755
[2250#] 363-0635 - 3/8"	3	N241-109	410760
1/2"	3	N241-117	410761



TWIST CLEVIS

KOCH

Item	Pack	Part #	HDI #
Forged carbon steel. Painted black.			
65621 - 3/4"	1	M8234-400450	410811
65622 - 7/8"	1	M8078-4004543	410812
65623 - 7/8" long	1	M8278-4004553	410805



BUILDERS HARDWARE

193LR



195LR



**ANCHOR SHACKLE**

**SWL: Safe Working Load**

**BARON**

Item	Pack	Part #	HDI #
<b>#193LR</b> Hot dipped galvanized steel. Screw pin type. Load rated to meet Federal Specification RR-C-271a Type IV Class 1.			
¼" Shackle x 5/16" Pin ½ Ton SWL	10	193LR-1/4	410570
5/16" Shackle x 3/8" Pin ¾ Ton SWL	10	193LR-5/16	410575
3/8" Shackle x 7/16" Pin 1 Ton SWL	10	193LR-3/5	410580
7/16" Shackle x ½" Pin 1½ Tons SWL	10	193LR-7/16	410801
½" Shackle x 5/8" Pin 2 Tons SWL	10	193LR-1/2	410590
5/8" Shackle x ¾" Pin 3¼ Tons SWL	10	193LR-5/8	410595
¾" Shackle x 7/8" Pin 4¾ Tons SWL	5	193LR-3/4	410600
7/8" Shackle x 1" Pin 6½ Tons SWL	1	193LR-7/8	410804
7/8" Long Shackle	1	49010600	410810
<b>#195LR</b> Hot dipped galvanized steel. Round pin type. Load rated to meet Federal Specifications RR-C-271b Type IV Class 4.			
5/16" Shackle x 3/8" Pin ¾ Ton SWL	10	195LR-5/8	410806
3/8" Shackle x 7/16" Pin 1 Ton SWL	10	195LR-3/8	410807
7/16" Shackle x ½" Pin 1½ Tons SWL	10	195LR-7/16	410808
¾" Shackle x 7/8" Pin 4¾ Tons SWL	10	195LR-3/4	410813



**EYE SLIP HOOKS**

**SWL: Safe Working Load**

**NATIONAL**

Item	Pack	Part #	HDI #
<b>3246BC</b> Grade 43. Blue Finish			
¼", 2,600 lb. SWL	5	N177-337	410645
5/16", 3,900 lb. SWL	5	N177-345	410650
3/8", 5,400 lb. SWL	3	N177-352	410655
½", 9,200 lb. SWL	1	N177-360	410665



**EYE GRAB HOOKS**

**NATIONAL**

Item	Pack	Part #	HDI #
<b>3244BC</b> Grade 43. Blue Finish			
¼", 2,600 lb. SWL	5	N177-295	410510
5/16", 3,900 lb. SWL	5	N177-303	410515
3/8", 5,400 lb. SWL	3	N177-311	410520



BUILDERS HARDWARE



**DOUBLE CLEVIS LINK**

Baron  
Heat treated. Zinc plated.

1/4 - 5/16 196  
(410601) N240-879

3/8  
5400# work load 196  
(410602) N240-887  
pk 10

7/16 - 1/2  
9200# work load 196  
(410603) N240-895  
pk 5



**HITCH PINS**

Campbell  
Forged. Red head series with clips.

1/2 x 3 5/8" T3898910  
(415198) 01500  
pk 5

5/8 x 4" T3898954  
(415200) 01501  
pk 5

5/8" x 5 1/2" T3898956  
(415204) 01502  
pk 5

3/4" x 4 1/4" T3898934  
(415201) 01503  
pk 2

3/4 x 6 1/2" T3898936  
(415205) 01504  
pk 2

7/8 x 6 1/2" T3898976  
(415206) 01506  
pk 1

1 x 7 1/2" T3898917  
(415207) 01508  
pk 1



**HITCH PINS**

Campbell  
Yellow Zinc plated wire handle w/clips.

3/8"x 3 T3899733  
(410814) \_\_\_\_\_  
pk 5

1/2" x 4 1/4" T3899724  
(410815) \_\_\_\_\_  
pk 5

5/8" x 3 3/4" T3899720  
(410816) \_\_\_\_\_  
pk 5

5/8" x 6" T3899752  
(410352) \_\_\_\_\_  
pk 5

3/4 x 4" T3899728  
(410817) \_\_\_\_\_  
pk 2

7/8" x 4 1/4" T3899736  
(415202) \_\_\_\_\_  
pk 2



BUILDERS HARDWARE



HITCH PIN CLIP

FarmEx/Speeco

Hair pin type zinc electroplated

3/16" x 3 3/4"

(410210) 0013

5/32" x 3"

(410215) 0012

1/8" x 2 1/16"

(410220) 0010

1/4" x 4 1/4"

(410225) 0014

pk 50



WINCH PULLER

American Power Pull

Double ratchet drive.

1/2 ton to 1 ton

(410291) 18500

1 ton to 2 ton

(410293) 18600

pk 1



BUILDERS HARDWARE



MALLEABLE WIRE ROPE CLIPS

BARON

Item	Pack	Part #	HDI #
Malleable iron saddle with steel U bolt. Galvanized.			
1/16"	25	260	270092
1/8"	25	260	270093
3/16"	25	260	270095
1/4"	25	260	270097
5/16"	25	260	270099
3/8"	25	260	270101
7/16"	10	260	270103
1/2"	10	260	270105
5/8"	10	260	270107
3/4"	10	260	270109



DROP FORGED WIRE ROPE CLIPS

CAMPBELL

Item	Pack	Part #	HDI #
Forged steel saddle with steel U bolt. Galvanized.			
1/8"	10	699-0234	270123
3/16"	10	699-0334	270125
1/4"	10	699-0434	270127
5/16"	10	699-0534	270129
3/8"	10	699-0634	270131
7/16"	10	699-0734	270133
1/2"	10	699-0834	270135
5/8"	10	699-1034	270137
3/4"	10	699-1234	270139



CABLE FERRULE SLEEVE

CAMPBELL

Item	Pack	Part #	HDI #
Aluminum sleeves, when properly applied are capable of holding the rated breaking strength of the cable to which they are applied.			
1/16"	100	ASCL	415160
3/32"	100	ASCL	415161
1/8"	100	ASCL	415162
5/32"	100	ASCL	415163
3/16"	50	ASCL	415164
1/4"	50	ASCL	415165



18" SWAGING TOOL

CAMPBELL

Item	Pack	Part #	HDI #
For ferrules and stops 1/16 to 3/16". Use on wire rope 1/8" - 3/16" for securing ferrules & stops onto wire rope or cable. Remove coating from assembly area on coated cable before swaging.			
	2	767-9038	415168



BUILDERS HARDWARE



GRIPPLE WIRE ROPE GRIPS

CAMPBELL

Item	Pack	Part #	HDI #
Joins, tension and terminate wire ropes. Replaces labor-intensive nuts, u-bolts, clips, grips, and sleeves. Impossible to install incorrectly. <b>Poly Bagged, 10 Packs/Box</b>			
1/4"	1	777-5439	410355



STANDARD WIRE ROPE THIMBLE

BARON

Item	Pack	Part #	HDI #
Stamped carbon steel. Hot galvanized			
767-0609 1/8"	25	264HG	270111
767-0619 3/16"	25	264HG	270113
767-0629 1/4"	25	264HG	270115
767-0639 5/16"	25	264HG	270117
767-0649 3/8"	25	264HG	270119
767-0659 1/2"	25	264HG	270121



VINYL COATED AIRCRAFT CABLE

CAMPBELL

Item	Pack	Part #	HDI #
Vinyl coating seals out grit, dirt and moisture. Protects hands, clothing and other materials that may come into contact or be used in conjunction with cable. [wire size x coated to]			
1/16" - 1/8" x 250' 28# work load 7 x 7 Green Coated Cable	1	700-0197	410300
3/32" - 3/16" X 250' 184# work load 7 X 7 flexible	1	700-0397	410275
1/8" - 3/16" x 250' 340# work load 7 x 7	1	700-0497	410280
3/16" - 1/4" x 250' 840# work load 7 x 19 extra flexible	1	700-0697	410285
1/4" - 5/16" x 200' 1400# work load 7 x 19 extra flexible	1	700-0897	410287



AIRCRAFT CABLE

CAMPBELL

Item	Pack	Part #	HDI #
For use wherever high strength in small diameters, combined with resistance to corrosion, fatigue, and stretching is required. Galvanized steel.			
1/16" x 500' 100# work load 7 x 7	1	700-0227	410235
3/32" x 500' 184# work load	1	700-0327	410236
1/8" x 500' 340# work load	1	700-0427	410240
3/16" x 250' 840# work load 7 x 19 extra flexible	1	700-0627	410250
1/4" x 250' 1400# work load 7 x 19 extra flexible	1	700-0827	410260
5/16" x 500' - Not Galv. 1700# work load 6 x 19	1	700-8227	410288
3/8" x 250' - Not Galv. 2400# work load 6 x 19	1	700-8327	410289



**QUICK LINKS**

**SWL: Safe Working Load**

**LOCK SNAP / BARON**

Item	Pack	Part #	HDI #
Connects instantly by simple tightening with wrench. Can be used repeatedly. Threaded connector permits easy closing and reopening. Designed for quick repair of chain links or for adding hooks and fitting to a chain. Use one size <i>larger</i> than chain size.			
1/8" 220 lb. SWL	10	7350	415099
3/16" 660 lb. SWL	10	7350	415101
1/4" 880 lb. SWL	10	7350	415103
5/16" 1760 lb. SWL	10	7350	415105
3/8" 2640 lb. SWL	10	7350	415107
1/2" 3300 lb. SWL	10	7350	415109

**NATIONAL**

Item	Pack	Part #	HDI #
<b>3167BC - Stainless Steel</b>			
1/8" 300 lb. SWL	3	N262-477	415301
3/16" 1150 lb. SWL	3	N262-485	415302
1/4" 1800 lb. SWL	3	N262-493	415303
5/16" 2500 lb. SWL	3	N262-501	415304
3/8" 3000 lb. SWL	3	N262-519	415305



**SPRING SNAPS**

**SWL: Safe Working Load**

**LOCK SNAP / BARON**

Item	Pack	Part #	HDI #
<b>2450 - Harp form steel, galvanized.</b>			
2" x 3/16" 100 lb. SWL	10	2450	415104
2 3/8" x 1/4" 140 lb. SWL	10	2450	415111
2 3/4" x 9/32" 200 lb. SWL	10	2450	415112
3 1/8" x 5/16" 280 lb. SWL	10	2450	415113
4" x 3/8" 400 lb. SWL	10	2450	415116
4 3/4" x 7/16" 500 lb. SWL	10	2450	415118

**NATIONAL**

Item	Pack	Part #	HDI #
<b>3166BC - Interlocking spring snaps. Stainless Steel</b>			
2 3/8" x 5/16" 400 lb. SWL	3	N262-394	415306
3 1/4" x 7/16" 800 lb. SWL	3	N262-402	415308
4" X 5/8" 925 lb. SWL	3	N262-410	415316
4 3/4" X 3/4" 1100 lb. SWL	3	N262-428	415307



BUILDERS HARDWARE



Round Eye



Loop Eye

**BOLT SNAPS - SWIVEL EYE**

**SWL: Safe Working Load**

NATIONAL

Item	Pack	Part #	HDI #
<b>3158BC - Round Swivel Eye, Stainless Steel.</b>			
1/2" x 3 3/8" 250 lb. SWL	3	N262-329	415310
3/4" x 3 9/16" 250 lb. SWL	3	N262-337	415311
<b>3159BC - Round Swivel Eye, Stainless Steel.</b>			
1/2" x 3" 170 lb. SWL	3	N262-345	415309
<b>3013BC 25 - Loop Swivel Eye, Nickel Finish</b>			
1" x 3 1/8" 70 lb. SWL	10	N222-638	415169
<b>3000BC 225 - Round Swivel Eye, Nickel Finish</b>			
3/8" x 2 3/16" 15 lb. SWL	10	N222-570	415002
<b>3001BC 225 - Round Swivel Eye, Nickel Finish</b>			
1/2" x 3" 45 lb. SWL	10	N222-588	415003
<b>3003BC - Round Swivel Eye, Nickel Finish</b>			
5/8" x 3 1/2" 115 lb. SWL	10	N222-596	415005
3/4" x 3 11/16" 120 lb. SWL	10	N222-604	415007
<b>3004BC - Round Swivel Eye, Nickel Finish</b>			
1 1/4" x 4 1/4" 100 lb. SWL	10	N222-612	415009
<b>3171BC - Round Swivel Eye, Solid Bronze</b>			
7/16" x 3" 150 lb. SWL	10	N258-616	415266
1/2" x 3" 110 lb. SWL	10	N223-180	415119
<b>3172BC - Round Swivel Eye, Solid Bronze</b>			
3/4" x 3 5/16" 170 lb. SWL	5	N258-582	415121
13/16" x 3 1/4" 150 lb. SWL	5	N223-198	415120
1 1/4" x 4 3/4" 225 lb. SWL	5	N258-590	415268
1 1/4" x 5" 380 lb. SWL	5	N258-608	415269
<b>3174BC - Round Swivel Eye, Solid Bronze</b>			
1" x 3 1/2" 150 lb. SWL	5	N223-206	415267
<b>3176BC - Loop Swivel Eye, Solid Bronze</b>			
1/2" x 2 7/8" 160 lb. SWL	10	N258-624	415271



Round Eye



Loop Eye



Open Eye

**BOLT SNAPS - FIXED EYE**

**SWL: Safe Working Load**

NATIONAL

Item	Pack	Part #	HDI #
<b>3006BC 125 - Round Fixed Eye, Nickel Finish</b>			
5/8" x 3 1/4" 130 lb. SWL	10	N222-620	415170
<b>3016BC 17 - Loop Fixed Eye, Nickel Finish</b>			
1" x 3 1/8" 40 lb. SWL	10	N222-646	415133
<b>3175BC - Open Fixed Eye, Solid Bronze</b>			
1/4" x 3 7/16" 150 lb. SWL	10	N223-214	415127



**BOLT SNAPS - DOUBLE BOLT**

NATIONAL

Item	Pack	Part #	HDI #
<b>3160BC - Stainless Steel.</b>			
3 15/16" 260 lb. SWL	3	N262-352	415313
<b>3031BC 162 - Nickel Finish</b>			
3 7/16" 85 lb. SWL	10	N222-679	415250
<b>3032BC - Nickel Finish</b>			
3 1/516" 100 lb. SWL	10	N222-687	415171
<b>3177BC - Solid Bronze</b>			
3 7/16" 115 lb. SWL	10	N223-222	415125
<b>3178BC - Solid Bronze</b>			
4 1/8" 215 lb. SWL	10	N258-657	415265
<b>3179BC - Solid Bronze</b>			
4 1/2" 140 lb. SWL	10	N223-230	415126





BUILDERS HARDWARE



Round Eye



Loop Eye

TRIGGER SNAPS - SWIVEL EYE

SWL: Safe Working Load

NATIONAL

Item	Pack	Part #	HDI #
<b>3161BC</b> - Round Swivel Eye. <b>Stainless Steel</b>			
1/2" x 2 5/8" 170 lb. SWL	3	N262-386	415312
<b>3041BC</b> - Round Swivel Eye. <b>Nickel Finish</b>			
1/2" x 2 5/8" 60 lb. SWL	10	N222-703	415176
<b>3180BC</b> - Round Swivel Eye. <b>Solid Bronze</b>			
1/2" x 2 5/8" 105 lb. SWL	10	N258-681	415132
<b>3181BC</b> - Loop Swivel Eye. <b>Solid Bronze</b>			
5/8" x 2 1/2" 110 lb. SWL	10	N258-699	415270



Round Eye



Loop Eye

SPRING SNAPS - FIXED EYE

NATIONAL

Item	Pack	Part #	HDI #
<b>3164BC</b> - Round Eye. <b>Stainless Steel</b>			
3/4" x 3 13/16" 300 lb. SWL	3	N262-360	415317
1 1/8" x 4 1/2" 500 lb. SWL	3	N262-378	415320
<b>3065BC 200</b> - Loop Fixed Eye. <b>Nickel Finish</b>			
3/4" x 2 1/4" 30 lb. SWL	5	N222-760	415019
<b>3066BC</b> - Loop Fixed Eye. <b>Nickel Finish</b>			
1" x 2 7/8" 35 lb. SWL	5	N222-778	415254
<b>3067BC</b> - Loop Fixed Eye. <b>Nickel Finish</b>			
1 1/4" x 3 1/4" 50 lb. SWL	5	N222-786	415255
<b>3190BC</b> - Round Fixed Eye. <b>Solid Bronze</b>			
3/4" x 3 15/16" 255 lb. SWL	5	N258-665	415275
1 1/16" x 4 1/2" 270 lb. SWL	5	N258-673	415276



Round Eye



Loop Eye



Open Eye

SPRING SNAPS

SWL: Safe Working Load

NATIONAL

Item	Pack	Part #	HDI #
<b>3050BC</b> - Round Swivel Eye. <b>Nickel Finish</b>			
7/16" x 2" 20 lb. SWL	10	N222-729	415251
<b>3051BC</b> - Round Swivel Eye. <b>Nickel Finish</b>			
1/2" x 2 5/8" 35 lb. SWL	10	N222-737	415174
<b>3052BC</b> - Round Swivel Eye. <b>Nickel Finish</b>			
3/4" x 3 5/8" 70 lb. SWL	10	N222-745	415252
<b>3060BC</b> - Loop Fixed Eye. <b>Nickel Finish</b>			
5/8" x 2 5/8" 30 lb. SWL	10	N222-752	415253
<b>3071BC</b> - Open Swivel Eye. <b>Nickel Finish</b>			
1/2" x 2 3/4" 30 lb. SWL	10	N222-794	415023



Round Fixed Eye



Round Swivel Eye

QUICK SNAPS

NATIONAL

Item	Pack	Part #	HDI #
<b>3163BC</b> - Round Fixed Eye. <b>Stainless Steel</b>			
#2 3/4" x 3 1/4" 320 lb. SWL	3	N262-436	415318
#3 3/4" x 3 5/8" 440 lb. SWL	3	N262-444	415319
<b>3165BC</b> - Round Swivel Eye. <b>Stainless Steel</b>			
#2 3/4" x 3 11/16" 270 lb. SWL	3	N262-451	415314
#3 3/4" x 4 3/8" 420 lb. SWL	3	N262-469	415315
<b>3189BC</b> - Round Fixed Eye. <b>Solid Bronze</b>			
#0 7/16" x 2 1/8" 115 lb. SWL	10	N223-248	415115
#1 5/8" x 2 3/4" 120 lb. SWL	10	N223-255	415128
#2 3/4" x 3 3/8" 180 lb. SWL	10	N223-263	415262
#3 3/4" x 3 13/16" 230 lb. SWL	10	N223-271	415129
<b>3191BC</b> - Round Swivel Eye. <b>Solid Bronze</b>			
#1 5/8" x 3 1/4" 150 lb. SWL	10	N223-289	415130
#2 3/4" x 3 5/8" 220 lb. SWL	10	N223-297	415263
#3 3/4" x 4 7/16" 230 lb. SWL	5	N223-305	415131



BUILDERS HARDWARE



SNAP HOOKS

SWL: Safe Working Load

NATIONAL

Item	Pack	Part #	HDI #
<b>3102BC - Round Swivel Eye. Nickel Finish</b>			
3/4" x 3 3/8" 125 lb. SWL	10	N222-836	415053
<b>3104BC - Round Swivel Eye. Nickel Finish</b>			
3/4" x 3 9/16" 125 lb. SWL	10	N222-844	415055



CATTLE SNAPS

NATIONAL

Item	Pack	Part #	HDI #
<b>3142BC - Round Swivel Eye. Nickel Finish</b>			
1" x 4 1/8" 250 lb. SWL	5	N222-968	415037
<b>3193BC - Round Swivel Eye. Solid Bronze</b>			
7/8" x 3 7/8" 220 lb. SWL	5	N258-996	415264



CHAIN SNAPS

NATIONAL

Item	Pack	Part #	HDI #
<b>3092BC - Open Swivel Eye. Zinc Plated</b>			
3/8" x 3 9/16" 110 lb. SWL	10	N222-802	415256
<b>3093BC - Open Swivel Eye. Zinc Plated</b>			
1/4" x 3 11/16" 150 lb. SWL	10	N222-810	415257



BIT SNAPS

SWL: Safe Working Load

NATIONAL

Item	Pack	Part #	HDI #
<b>3116BC - Zinc Plated</b>			
5/16" x 1 3/4" 115 lb. SWL	20	N222-919	415258



ROPE SNAPS

NATIONAL

Item	Pack	Part #	HDI #
<b>3096BC 407 - Round Swivel Eye. Zinc Plated.</b>			
3/4" x 4 1/2" 150 lb. SWL	10	N222-828	415025



BREECHING SNAPS

NATIONAL

Item	Pack	Part #	IBM #
<b>3114BC 424 - Zinc Plated</b>			
5/16" x 2 1/4" 85 lb. SWL	20	N222-901	415027



BUILDERS HARDWARE



Round Eye



Loop Eye

SWIVELS

SWL: Safe Working Load

NATIONAL

Item	Pack	Part #	HDI #
<b>3135BC 2225 - Round Eye. Nickel Finish</b>			
5/8" x 5/8" 105 lb. SWL	10	N222-943	415047
<b>3138BC - Loop Eye. Nickel Finish</b>			
1" x 1" 55 lb. SWL	10	N222-950	415260



RINGS

SWL: Safe Working Load

NATIONAL

Item	Pack	Part #	HDI #
<b>3155BC - Zinc Plated</b>			
#7 x 1" 195 lb. SWL	10	N223-123	415065
#4 x 1 1/4" 270 lb. SWL	10	N223-131	415067
#3 x 1 1/2" 300 lb. SWL	10	N223-149	415069
#2 x 2" 300 lb. SWL	10	N223-156	415071
<b>3156BC - Solid Brass</b>			
1" 195 lb. SWL	10	N258-707	415277
1 1/4" 235 lb. SWL	10	N258-723	415279
1 1/2" 275 lb. SWL	10	N258-731	415280
1 3/4" 300 lb. SWL	10	N258-749	415281
2" 325 lb. SWL	10	N258-756	415282



ROPE CLEATS

NATIONAL

Item	Pack	Part #	HDI #
<b>3200BC 4015 - Nickel Finish</b>			
2 1/2" 35 lb. SWL	10	N223-321	415059
4 1/2" 55 lb. SWL	10	N223-339	415061
6" 30 lb. SWL	10	N223-347	415063
<b>3200BC - Brass Finish</b>			
2 1/2" 35 lb. SWL	10	N223-313	415283



ROPE CLAMP

CAMPBELL CHAIN

Item	Pack	Part #	HDI #
4 point nickel plated. 2 per pack			
	10	B767-9034	415177



BUILDERS HARDWARE

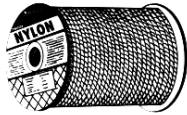

**SOLID BRAID NYLON**

LEHIGH

Item	Pack	Part #	HDI #
Extremely strong, soft, lightweight cord with excellent resistance to rot, abrasion, mildew, petroleum products, and most chemicals. Shock absorbing elasticity that allows it to withstand great strain. Natural silvery white color.			
On a Spool [Safe Working Load #]			
1/8" x 600' #4 [26]	1	SNR46	735161
3/16" x 475' #6 [52]	1	SNR64	735167
3/16" x 1200' #6 [52]	1	SNR612	735169
1/4" x 200' #8 [90]	1	SNR82	735171
1/4" x 1200' #8 [90]	1	SNR812	735173
5/16" X 175' #10 [135]	1	SNR101	735174
5/16" x 600' #10 [135]	1	SNR106	735175
3/8" x 125' #12 [192]	1	SNR121	735177
3/8" x 500' #12 [192]	1	10172	735179
1/2" x 250' #16 [323]	1	10186	735222
Packaged			
3/16" x 50'	6	N650W	735076
3/16" x 100'	6	16363	735078
1/4" X 50'	8	N850W	735077
1/4" x 100'	12	16365	735079
5/16" X 50'	12	16367	735080



**TWISTED NYLON ROPE**

LEHIGH

Item	Pack	Part #	HDI #
4-stage firm lay construction. Has elasticity to absorb shock loads that could snap ropes made of other fibers. Excellent resistance to rot and abrasion and is not damaged by mildew, oil, grease, gas, marine growth, or many chemicals.			
On a Spool [Safe Working Load #]			
1/4" x 600' [136]	1	10975	735191
3/8" x 600' [292]	1	10999	735199
1/2" X 300' [525]	1	TN230	735201
Packaged			
1/4" x 50'	24	NPP450	735070
1/4" x 100'	12	NPP4100	735071
3/8" x 50'	4	NPP850X	735072

**UNMANILA ROPE**

LEHIGH

Item	Pack	Part #	HDI #
Specialty formulated twisted polypropylene rope that is much stronger, has half the weight, and costs less than manila rope. Resistant to rot, abrasion, and is not damaged by petroleum products, mildew, marine growth or many chemicals.			
On a Spool [Safe Working Load #]			
1/4" x 1200' [113]	1	FPB412	735151
3/8" x 600' [244] Box	1	FPB860	735153
1/2" x 300' [420]	1	FPB230	735155
Packaged			
1/4" x 100'	12	25660	735085



**SISAL ROPE**

88053



16212

**LEHIGH**

Item	Pack	Part #	HDI #
An economically priced rope for many uses; around home, in farming, and in industry. Good for one way truck and trailer load tie downs.			
[Safe Working Load #]			
¼" x 1500' [39] Box	1	88053	735125
½" x 665' [170] Spool	1	22-600	735133
<b>Mini Coil - Packaged</b>			
¼" x 50'	12	16212	735137
¼" x 100'	12	11345	735093



**MANILA ROPE**

**LEHIGH**

3-strand stretch resistant rope with good knot holding ability.			
Packaged			
¼" x 50'	1	28764	735094



14990



PT450

**POLYPROPYLENE ROPE**

**LEHIGH**

Item	Pack	Part #	HDI #
3-strand monofilament Yellow. First class, 100% twisted monofilament. Almost twice as strong as manila rope & will last longer due to resistance to rot, abrasion, mildew, petroleum products, marine growth, & many chemicals. Floats on surface of water.			
On a Spool [Safe Working Load #]			
¼" x 1200' [106]	1	14990	735213
3/8" x 600' [230]	1	15019	735215
½" x 300' [420]	1	PY230	735217
5/8" x 200' [700]	1	PY582	735219
Packaged			
¼" x 50'	24	PT450	735073
¼" x 100'	12	PT4100	735074
3/8" x 50'	24	PT850	735075
<b>Hollow Braided</b>			
On a Spool [Safe Working Load #]			
¼" x 1200' [100]	1	HB412	735226
3/8" X 500' [135]	1	10841	735230
Packaged			
30645 ¼" x 50'	24	DF450	735089
¼" x 100'	12	DF4100	735090
3/8" x 50'	24	DF850	735091



BUILDERS HARDWARE



CMFP875-12



CMFP3PK-36



46309

65328

POLYPROPYLENE ROPE

LEHIGH / WELLINGTON

Item	Pack	Part #	HDI #
<b>Twisted Camo Rope</b> - Less slippery than other poly ropes. Floats. Holds knots well. Flexible. Resistant to gas, oil, rot, mildew, and other chemicals. Used for camping, animal tie, pool marker, ladder replacement.			
1/4" x 50' Polybag	6	CF450W	735814
1/4" x 50' Storage Strap	12	73394	735817
<b>Diamond Braid Camo Rope</b> - Resists rot and mildew. Camouflage color great for hunter, camper, or outdoorsman. Easier to handle than twisted poly or natural fiber.			
3/8" x 75' Hank	12	CMFP875-12	735815
3 Pack: 5/16" x 45', 5/32" x 45', & Carabiner	36	CMFP3PK-36	735816
<b>Sportsman Camo Cord</b> - Designed for outdoor use. Variety of size and materials for many applications. Ties easily and securely.			
Cord 1/8" x 50' Spool	15	11120	735810
Rope 1/4" x 50' Storage Strap	12	11117	735811
<b>Catfisher's Olive Drab Twine</b> - Developed especially for catfishers. Each line's unique purpose is called out on label. <b>Drop Line:</b> use for drop lines, boating, recreation. <b>Set Line:</b> Ideal for trot lines, pole lines, jug lines, bank lines, drop lines, decoy lines, and limb lines.			
# 18 x 260" Drop Line	12	46309	735812
#60 x 300' Set Line	4	65328	735813



Mason Line



Kite Twine



Post Twine



Nylon Cord



Polyester Cord



Diamond Braid Rope

CORD, TWINE & ROPES

LEHIGH

HDI #	Pack	Part #	HDI #
<b>Venetian Blind Cord</b> - Nylon yarn jacket solid braided over a yarn core. Natural. 48' Single Hank			
9/64	12	13435	735565
<b>Kite Twine</b> - Soft spun polyester fiber. Long lasting, strong, non-conducting. Handles and knots well. Holds securely. White 600' shrink wrapped tube.			
	12	12681	735650
<b>Kitchen Twine</b> - For crafts, business, and household uses. Natural soft fiber handles easily and holds knots securely.			
# 16 x 250'	6	89829	735655
<b>Nylon Parachute Cord</b> - A high quality, economically priced cord. It is strong and resistant to rot, mildew, abrasion, oil, grease, gasoline, marine growth, and most chemicals.			
5/32" x 40' [45#]	12	HN845-12	735081
<b>Nylon Multi-Purpose Cord</b> - An excellent cord with a strong, abrasion resistant, nylon jacket braided over synthetic fiber core. Handy for hundreds of uses.			
1/8" x 48' [68#]	12	15634	735092
<b>"Rugged" Diamond Braid Poly Rope</b> - Tough, 32-strand cover provides maximum abrasion resistance. Won't absorb water.			
3/8" x 50' [216#]	12	P32C1250	735087



BUILDERS HARDWARE



14255



87637



43915

TWINE

LEHIGH

Item	Pack	Part #	HDI #
<b>Natural Jute Twine</b> - Used for everything from gardening to package wrapping. Biodegradable. 3 ply/medium, coreless ball			
208' Brown	6	14255	735600
115' Green	12	6710	735605
<b>Poly Twine</b> - Rot and abrasion resistant. Long lasting, heavy weight. For package wrapping and general heavy duty use. White & Blue. Dispenser carton.			
8600'	1	87637	735660
<b>Sisal Binder Twine</b> - Economical 1 ply twine has many general purpose uses. Natural tan color. Biodegradable. 8#, 2500'			
	10	43915	735220



SOLID BRAID SASH CORD

WELLINGTON

Item	Pack	Part #	HDI #
Fine cotton, yarn, lockstitch construction, pre-stretched and polished. Each hank labeled and protected with clear shrink wrap. 100' Hank			
#6 [3/16]	12	10195	735505
#7 [7/32]	12	10208	735510
#8 [1/4]	12	11971	735515
#12 [3/8]	12	10262	735525



BUILDERS HARDWARE

**SMALL DIAMETER CARDED WIRE**

**NATIONAL**

Tangleproof packaging. Wires reel off straight. Store in package, rewind unused portion, wrap end around top.

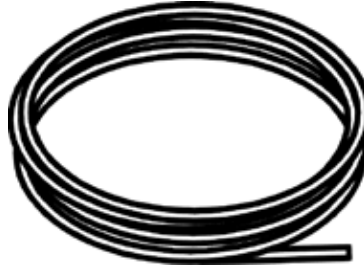

**18 GA Galvanized**

110' carded 28018  
(735735) N264-762

**19 GA Galvanized**

50' carded 40191  
(735785) N264-770

**19 GA Stainless Steel**

30' carded  
(220484) N264-705

**20 GA Galvanized**

175' carded 28020  
(735740) N264-788

**22 GA Galvanized**

100' carded 40225  
(735765) N264-796

**24 GA Galvanized**

250' carded 28024  
(735745) N264-804

**28 GA Galvanized**

100' carded 40281  
(735775) N264-812  
pk 5

**18 GA Aluminum**

50' carded 40185  
(735770) N264-697

**28 GA Brass**

75' carded 40285  
(735780) N264-739

**18 GA Copper**

25' carded 40183  
(735750) N264-747

**24 GA Copper**

100' carded 40246  
(735760) N264-754

**19 GA Annealed**

50' carded 40192  
(735755) N264-713

**28 GA Annealed**

100' carded  
(220485) N264-721  
pk 5

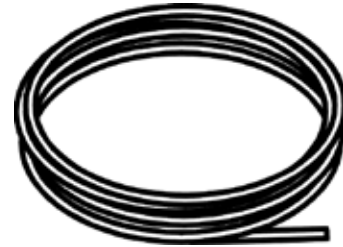

**PLANT FLORAL WIRE**

**NATIONAL V2674/V2571**

24 GA Green Finish  
100' carded

(230788) N264-820  
N274-985

pk 5



**ANNEALED WIRE**

**NATIONAL 2568**

(Steel on a stick).

16 GA x 200'

(220490) N267-005

pk 5



**TRANSPARENT WIRE**

**NATIONAL 2572**

Clear

25 GA x 30'

(220486) N265-314

pk 5





**COIL TIE WIRE**

Item	Pack	Part #	HDI #
Center hole (semi-square with round corners) enables roll to be quickly reversed for right or left hand use. Roll slips quickly onto the reel, yet easily rewinds. Continuous rolls and uniform diameters. Ideal to tie rods. Meets ASTM-A-853. 16.5 gauge.			
3.5lb - 330'	20	5689/ RBTW35	235311



**SOFT GALVANIZED WIRE**

**NATIONAL 2568BL**

Item	Pack	Part #	HDI #
Packaged coils for many uses around the home, shop and farm.			
12 ga - 100'	5	N266-973	220488
14 ga - 100'	5	N266-981	235300
16 ga - 200'	5	N266-999	220487



**MECHANIC WIRE**

**SECURE PRODUCTS**

Item	Pack	Part #	HDI #
5# spool. Black annealed wire for jobs where more than 50' is required. Or where it is more economical to buy in larger quantity.			
16 ga - 480'	10	31516	235309
18 ga - 830'	10	31518	235310



**BLACK/ANNEALED SMOOTH WIRE**

**MAT**

Item	Pack	Part #	HDI #
General purpose wire. Annealed wire is soft and pliable; easy to form and twist.			
(317677A) -100# coil [.1483 / 1705']	1	9 ga	235282



**GALVANIZED SMOOTH WIRE**

**MAT**

Item	Pack	Part #	HDI #
General purpose wire galvanized for high corrosion resistance.			
10# Coil			
[.1483] 9 ga	10	317527A	235273
[.1055] 12½ ga	10	317524A	235279
100# coil			
[.1055 / 3369'] 12½ ga		317574A	235264



BUILDERS HARDWARE



TWES HWES MWES  
TOE, HAND, POCKET WARMERS



RUBBER / NITRILE GLOVES

Item	Pack	Part #	HDI #
<b>Toe Warmers</b> - shapes to fit tow of foot. Adhesive backing allows you to stick to outside of sock and enjoy up to 7 hours of warmth. Air Activated			
2 per pack	40		738993
<b>Hand Warmers</b> - lasts up to 7 hours. Air activated when removed from package.			
2 per pack	25		738992
<b>Large Warmers</b> - Used in areas such as pockets. Lasts up to 12 hours. Air Activated. Hand & Body			
1 per pack	40		738994

CORDOVA

Item	Pack	Part #	HDI #
<b>Nitrile</b> - Industrial grade unlined nitrile resists cuts, snags, and abrasions. Embossed grip for safety. Resistant to common lawn and garden chemicals.			
	12 pr	46109	738205
<b>Rubber</b> - Tough, flexible neoprene rubber blend protects against paint, refinshers and other liquids. Cotton flock lined, embossed grip.			
	12 pr	43401	738209

FEET WARMERS



SAFETY WORKS

Item	Pack	Part #	HDI #
<b>Toasty Feet™</b> - Shoes insoles men sizes 8-12. Keeps feet comfortable all day long. Protects feet from extremely hot or cold surfaces			
1 pair per pack	12	CTFM	710125



DISPOSABLE WORK GLOVES



SAFETY WORKS

Item	Pack	Part #	HDI #
3 grades of glove: Latex (good grade), Vinyl (better grade), Nitrile (best grade - lasts 3 times longer than latex).			
Latex			
10 pc. Poly Bag	12	C505910PL	710086
50 pc. Box	12	40251	710122
100 pc. Box	10	CP5059L	710120
Green Vinyl			
100 pc. Box	10	C6060L	710089
Blue Nitrile			
10 pc. Poly Bag	12	C6002TPL	710088
50 pc. Box	6	C600150PL	710121

LATEX GLOVES



CORDOVA

Item	Pack	Part #	HDI #
<b>Deluxe Hand Care Glove</b> - Yellow, medium weight natural latex. Extra long length. Embossed grip for safe handling. Soft cotton flock lining and contour fit.			
	12 pr	42502	738201

LINZER

Item	Part #	HDI #
Gloves can be worn on the right or left hand. All Comfortable and easy to work with. Beaded cuff for extra strength. Ideal for staining, painting, caulking, glueing, patching walls, hobbies, and crafts. <b>100 ct Box</b>		
Powder Free - Nitrile	GLN100L	376724



BUILDERS HARDWARE



14301 15101  
**JERSEY GLOVES**

17101 16001

CORDOVA

Item	Pack	Part #	HDI #
<b>Heavyweight</b> - Clute pattern, 12 oz. knit poly/cotton fabric stretches to fit snugly over the hand. Provides dexterity, warmth and comfort. Knit wrist cuff.			
	12	14301	738603
<b>Plastic Dot Heavyweight Glove</b> - Poly/Cotton with Hob-Nob dots on palm and forefinger. Straight thumb, knit wrist, and clute cut.			
Large	12	15101	738004
<b>All Purpose</b> - Poly/Cotton with straight thumb, knit wrist and clute cut.			
Brown - Extra Large	12	820-XL	738712
Brown - Large	12	14021	738600
Brown - Youth Size	12	14003	738001
Hunter Orange - Large	12	17101	738708
Camouflage - Large	12	18401	738710
<b>All Purpose Lined</b> - Jersey with jersey fleece lining. Straight thumb, shirred wrist, and gunn cut.			
Large	12	16001	738005



72201  
**LEATHER PALM WORK GLOVES**

71201

CORDOVA

Item	Pack	Part #	HDI #
Grey suede cowhide leather palm, thumb, full forefinger, knuckle strap and continuous heel. Safety cuff, wing thumb, bound hem.			
	12	72201	738015
Grey suede cowhide leather palm. Knit wrist, straight thumb, clute cut.			
	12	71201	738016

**HI-VIZ  
GRAIN PIGSKIN SAFETY CUFF**



KINCO

Item	Pack	Part #	HDI #
3M™ Scotchlite. Reflective Material. Safety orange nylon back. Safety cuff			
Medium	12	1918-M	738653
Large	12	1918-L	738654
Extra Large	12	1918-XL	738670
Extra Extra Large	12	1918-XXL	738671

**LADIES GARDEN GLOVES**



CORDOVA

19453

Item	Pack	Part #	HDI #
<b>All Purpose Garden Glove</b> - Floral canvas. Ladies size.			
	12	19453	738069



**CANVAS GLOVES**

CORDOVA

Item	Pack	Part #	HDI #
<b>White</b> - Knit wrist, straight thumb, clute cut.			
	12	20001	738010
<b>White w/Plastic Dot</b> - 100% cotton with plastic dots on palm, thumb and forefinger.			
	12	26101	738502

**CHORE GLOVES**



KINCO

Kinco

Cordova

Item	Pack	Part #	HDI #
<b>Heavyweight - 18 oz Green Chore Glove</b> - knitwrist, wing thumb			
Large	12	818-L	738014
Extra Large	12	818-XL	738012
Double Extra Large	12	818-XXL	738695

CORDOVA

Item	Pack	Part #	HDI #
<b>16 oz Yellow Cotton Chore Glove</b> with straight thumb, knitwrist, and heavy napped.			
Large	12	23301	738011

**KNIT GLOVES**



CORDOVA

Item	Pack	Part #	HDI #
<b>Magic Stretch Gloves</b> - One size adult knitted gloves. Assorted Colors.			
	12	36103	738217



BUILDERS HARDWARE



GRIPPING GLOVES

KINCO

Item	Pack	Part #	HDI #
<b>Blue Latex Palm Glove</b> - allows optimal gripping even when wet.			
Small	12	1791S	738663
Medium	12	1791M	738664
Large	12	1791L	738665
Extra Large	12	1791XL	738666

CORDOVA

Item	Pack	Part #	HDI #
<b>Blue Latex Palm Glove</b> - Economy, Natural, 10-Gauge Poly/Cotton Shell with Blue Latex Coating			
Large	12	38931	738113
<b>Orange String Knit PVC Honeycomb</b> - Seamless knit with non-slip vinyl crisscross on both sides.			
	12	39001	738018
<b>Camouflage</b> - Knit. PVC dots.			
	12	H-38611	738714



1787



1788

GRIPPING GLOVES - THERMAL LINED

KINCO

Item	Pack	Part #	HDI #
<b>Foam Frost Breaker Thermal Gloves</b> - Durable foam latex coated gripping glove. 100% heavy thermal acrylic knit shell. Brown shell/Black palm			
Small	6	1787S	738704
Medium	6	1787M	738705
Large	6	1787L	738673
Extra Large	6	1787XL	738675
<b>Frost Breaker Camo Thermal Shell &amp; Latex Palm</b>			
Small	6	1788S	738101
Medium	6	1788M	738102
Large	6	1788L	738104
Extra Large	6	1788XL	738105



39991

GRIPPING GLOVES - THERMAL LINED

CORDOVA

Item	Pack	Part #	HDI #
<b>Cold-Snap</b> - Green, Brushed, Loop-In, 7-Gauge, Acrylic Terry Shell with Black Foam Latex Coating.			
Large	6	39991	738114
X-Large	6	39994	738212

NITRILE COATED GLOVES



CORDOVA

Item	Pack	Part #	HDI #
Nitrile Palm Coating. Smooth Finish. Gray Nylon Shell.			
Small	12	68903	738017
Medium	12	68902	738207
Large	12	68901	738716
X-Large	12	68904	738717

NEOPRENE COATED GLOVES



KINCO

Item	Pack	Part #	HDI #
Black neoprene over cotton interlocking lining. Smooth finish, wing thumb, knit wrist.			
	6	6370L	738037

PVC COATED GLOVES



KINCO

Item	Pack	Part #	HDI #
Hi-Vis Orange PVC with cotton interlock lining. "Sandy" grip, wing thumb, knit wrist.			
	6	4170-L	738041
Black PVC over cotton fleece lining. "Sandy" finish, wing thumb, 12" gauntlet cuff.			
	6	7182L	738039



BUILDERS HARDWARE



GOATSKIN DRIVERS GLOVE

CORDOVA

Item	Pack	Part #	HDI #
<b>Unlined</b> - Quality grain goatskin, keystone thumb, shirred elastic back.			
Small	12	85213	738210
Medium	12	85212	738211
Large	12	85211	738067
Extra Large	12	85214	738213



1927L



1927KW-L

COLD WEATHER GLOVES

KINCO

Item	Pack	Part #	HDI #
Thermal lined pigskin. Safety cuff. Leather palm, thumb, and fingers.			
Large	6	1927L	738650
Extra Large	6	1927XL	738652
Thermal lined pigskin. Knit wrist. Leather palm, thumb, and fingers.			
Large	6	1927KW-L	738655
Extra Large	6	1927KWXL	738660



ALL SEASON WORK GLOVES

KINCO

Item	Pack	Part #	HDI #
Soft-touch fleece lining. Split cowhide leather. Safety cuff. Knuckle strap.			
Large	12	1721GR-L	738662
Extra Large	12	1721GR-XL	738661



79102



78001



82201



82221

COWHIDE DRIVERS GLOVES

CORDOVA

Item	Pack	Part #	HDI #
<b>Lined</b>			
<b>Suede</b> - Suede cowhide with acrylic pile lining. Shirred wrist			
Medium	12	79102	738029
Large	12	79101	738031
Extra Large	12	79104	738028
<b>Grain</b> - Deluxe grain cowhide with thinsulate lining. Shirred wrist			
Medium	12	82552	738075
Large	12	82551	738073
Extra Large	12	82554	738077
<b>Unlined</b>			
<b>Suede</b> - Bucktan suede cowhide. Shirred wrist.			
Medium	12	78002	738021
Large	12	78001	738019
Extra Large	12	78004	738020
<b>Deluxe Grain</b> - Cowhide with shirred wrist.			
Medium	12	82202	738026
Large	12	82201	738027
Extra Large	12	82204	738033
<b>Palomino Grain</b> - Cowhide with pull strap wrist.			
Medium	12	82222	738025
Large	12	82221	738023
Extra Large	12	82224	738700



PIG SKIN LINED DRIVERS GLOVE

CORDOVA

Item	Pack	Part #	HDI #
100 gram Therma-Cor Lining cold weather gloves			
Large	12	COR606330	738701
Extra Large	12	COR606331	738702



BUILDERS HARDWARE



GENERAL UTILITY GLOVES



WATERPROOF WINTER GLOVES

YOUNGSTOWN

Item	Pack	Part #	HDI #
<b>General Utility Plus Lined w/Kevlar</b> Cut-resistant. Glove is fully lined with 100% KEVLAR brand fiber. Double-stitched asphalt palm reinforced in critical wear areas. Heavy duty reinforced nylon in between fingers. Padded knuckle protection. Adjustable hook and loop closure.			
Large	6	3080L	738927
Extra Large	6	3080XL	738926
<b>General Utility Plus</b> The general utility plus is a versatile, full finger work glove made for abrasive tasks.			
Large	6	3060L	738916
Extra Large	6	3060XL	738917
Extra Extra Large	6	3060XXL	738919
<b>Safety Orange General Utility</b> The safety orange general utility glove is made with breathable stretch nylon for year round abrasive applications.			
Extra Large	6	3700XL	738912



KNIT CAPS

LIBERTY GLOVES

Item	Pack	Part #	HDI #
<b>Knit Caps</b>			
Black	120	S3501B	738731
Assorted Colors	120	S3502B	738732

YOUNGSTOWN

Item	Pack	Part #	HDI #
<b>Waterproof Winter Plus</b> - The Waterproof Winter Plus features a waterproof, windproof, breathable membrane, insulating micro fleece liner, and a durable outer shell.			
Medium	6	3450M	738900
Large	6	3450L	738901
Extra Large	6	3450XL	738902
Extra Extra Large	6	3450XXL	738903
<b>Waterproof Winter Slip Fit</b> - the ultimate winter work glove. Specially designed to keep your hands warm and dry without sacrificing dexterity. 100% Waterproof Triple Layer Technology comprises of a micro-fleece liner, waterproof membrane, and form-fit outer shell. Durable, dexterous, comfortable and warm.			
Medium	6	3420M	738955
Large	6	3420L	738956
Extra Large	6	3420XL	738957
Extra Extra Large	6	3420XXL	738958
<b>Safety Orange Waterproof Winter</b> The safety orange waterproof winter glove is made for cold and wet conditions where visibility is important.			
Medium	6	3610M	738940
Large	6	3610L	738941
Extra Large	6	3610XL	738942
Extra Extra Large	6	3610XXL	738943
<b>Waterproof Winter XT</b> - Gray and Black. Keeps hands warm and dry. 200 gram 3M Thinsulate for extra warmth. Heavy duty non-slip palm reinforcement increases grip and durability. Large gauntlet cuff extends over jacket sleeve for superior warmth. The waterproof/windproof/breathable membrane will keep your hands dry.			
Large	6	3460L	738931
Extra Large	6	3460XL	738932
<b>Camo Waterproof</b> - Waterproof, windproof, and breathable membrane. Mossy oak new "Break-up" pattern on back of hand. Sportwool liner for exceptional warmth. Synthetic leather palm with extensive reinforcement. Precurved design is form-fit to hand. Will not harden or stretch like real leather.			
Medium	6	3470M	738921
Large	6	3470L	738922
Extra Large	6	3470XL	738923



BUILDERS HARDWARE

CARPENTER PLUS



YOUNGSTOWN

Item	Pack	Part #	HDI #
This is the "cut-finger" version of the General Utility Plus. Shortened middle, index fingers and thumb.			
Large	6	3110L	738964
Extra Large	6	3110XL	738965

PRO XT WORK GLOVE



YOUNGSTOWN

Item	Pack	Part #	HDI #
The Pro XT is an all-duty work glove designed for abrasive applications and tasks.			
Large	6	3050L	738906
Extra Large	6	3050XL	738907
Extra Extra Large	6	3050XXL	738908

ANTI-VIBE



YOUNGSTOWN

Item	Pack	Part #	HDI #
GripFlex palm reinforced for secure grip. 3.0mm foam on palm to dampen shock and vibrations. FlexMesh wrist wrap for added support. Ergonomic one-piece saddle.			
Large	6	3200L	738935
Extra Large	6	3200XL	738936

MECHANICS PLUS



YOUNGSTOWN

Item	Pack	Part #	HDI #
Padded palm and is built for comfort and dexterity. Oil & water resistant. Adjustable velcro closure.			
Large	6	3020L	738960
Extra Large	6	3020XL	738961

TRADESMAN PLUS



YOUNGSTOWN

Item	Pack	Part #	HDI #
The Tradesman Plus features a reinforced suede palm and is built for comfort, dexterity, and abrasion resistance. Synthetic suede reinforced increases durability. Oil & water resistant. Adjustable velcro closure. Terry cloth thumb for wiping sweat & debris. Breathable stretch nylon.			
Medium	6	3040M	738896
Large	6	3040L	738897
Extra Large	6	3040XL	738898
Extra Extra Large	6	3040XXL	738899



**BUILDERS HARDWARE**



54022

54034

54041



54071

54073

54091

**BOOT PRODUCTS**

**JOBSITE**

Item	Pack	Part #	HDI #	
<b>Mens Work Insole</b> - Everyday comfort for all types of casual and work footwear. Breathable fabric wicks away moisture. Antibacterial to reduce odor causing bacteria. Double layer covering is lightweight, durable, and heat resistant. Visco elastic heel insert absorbs and dissipates heel shock. One size - trim replacement insoles at toe to desired size.	6	54022	354022	
<b>Silicone Waterproof</b> - Ideal for leather and fabric boots, luggage, gun cases, saddlery, baseball gloves, safety belts, gloves, etc. Penetrates leather to lubricate and waterproof the fibers. Repeat as necessary. Apply liberally on material. Caution: Not for use on patent leather and vinyl.	6	54034	354034	
<b>Boot Tray</b> - Plenty big enough to hold 3 pair of boots/shoes. Perfect for farm boots, gardening supplies or even pet needs. Heavy gauge molded plastic with reinforcement for good support. Side walls to hold in melted ice and water puddles. Sturdy, yet portable and lightweight for any location.	6	54041	354041	
<b>Ice Claw</b> - Walk safer on slippery snow and ice. Grabs traction on ice. Bites into packed snow. Makes outdoor work and play safer. Fits all Footwear - Men, Women, Youth. Boots - hunting / work / hiking. Shoes - casual / dress / sport. Quick and Easy On . . . Quick and Easy Off. Stretch easily with one motion over your shoes or boots. Handy heel tab for two-finger, one motion removal. Just fold up and carry in jacket pocket.	Regular	6	54071	354071
	Big Foot - Large	6	54073	354073
<b>Boot Dryer</b> - Use on all types of materials including leather, PVC, rubber, neoprene, canvas, synthetics, cloth, fleece, felt, micro and other modern fabrics. Eliminates odors caused by sweat and bacteria. Extends the life of footwear, clothing and gear. Thermal convection is safe, no motor, no noise; air circulates naturally. Compact and portable, yet tough and powerful.	6	54091	354091	

**BOOT SCRUBBER**



**JOBSITE**

54098

Item	Pack	Part #	HDI #
<b>Boot Scrubber</b> - Composite molded plastic construction is long lasting and will not rot or ruin from elements of snow, rain, barnyard acids or weather. Heavy gauge welded metal frame is rugged to take abuse and misuse. Built-in sole and edge scraper to clean off those tough to get at place. Great boot, shoe and footwear cleaning tool scrubber, scraper and cleaner all in one.	6	54098	354098

**QUALITY RAINSUIT**

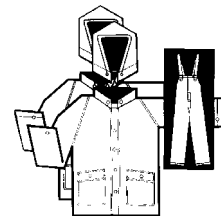

**CORDOVA**

Item	Pack	Part #	HDI #	
3 piece rainsuit. Jacket, bib-overall, detachable hood. 35mm PVC bonded to polyester. All are oversized with 32" long jacket for comfort. 100% waterproof. Entirely non-conductive. Yellow.	Medium	10	RS353YM	738971
	Large	10	RS353Y-L	738972
	X Large	10	RS353Y-XL	738973
	XX Large	10	RS353Y-2XL	738974
	XXX Large	10	RS353Y-3XL	738975

**SLUSH BOOTS**



**CORDOVA**

Item	Pack	Part #	HDI #	
17" high over-the-shoe style, stop strap with buckle. Deep seated heel and rugged treaded sole. Fits comfortably over work shoes. High visibility yellow.	#12	6	BYS17-12	738980
	#13	6	BYS17-13	738981
	#14	6	BYS17-14	738982
	#15	6	BYS17-15	738983
	#16	6	BYS17-16	738984