

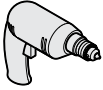
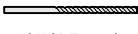
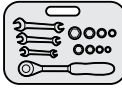

<p>Recommended tools Herramientas recomendadas Outils Recommandés</p> <p>Electric drill Taladro eléctrico Perceuse électrique</p>  <p>Drill bit Broca de taladro Mèche de perçreuse</p>  <p>1/4" (6.5 mm)</p> <p>Wrench and socket set Juego de llave y cubo Ensemble clés et douilles</p>  <p>Level Nivel Niveau</p> 	<p>Parts in the box Herramientas necesarias Pièces dans la boîte</p>  <p>A (Track)</p> <p>B (Bracket)</p> <p>H3 (Screws)</p> <p>H4 (Screws)</p> <p>H5 (Washers)</p> <p>J (Bracket)</p> <p>K (Nuts)</p> <p>L (Corner Bracket)</p>
---	---

A If track is already installed, remove door stop and hole caps before installing track extension.

Si la vía ya está instalada, retire el tope de puerta y los toques para orificios antes de instalar la extensión de la vía.

Si le rail est installée, retirez le butoir de porte et les cache-trous avant d'installer l'extension du rail.

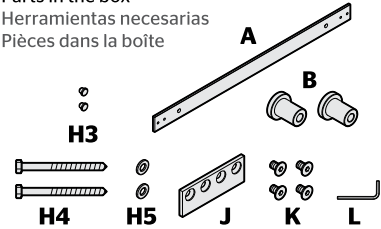
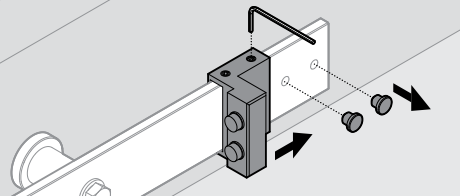

B Connect tracks and secure track to header board.

Conecte las vías y fije la vía a la placa de cabecera.

Connectez les rails et fixez le rail à la traverse supérieure.

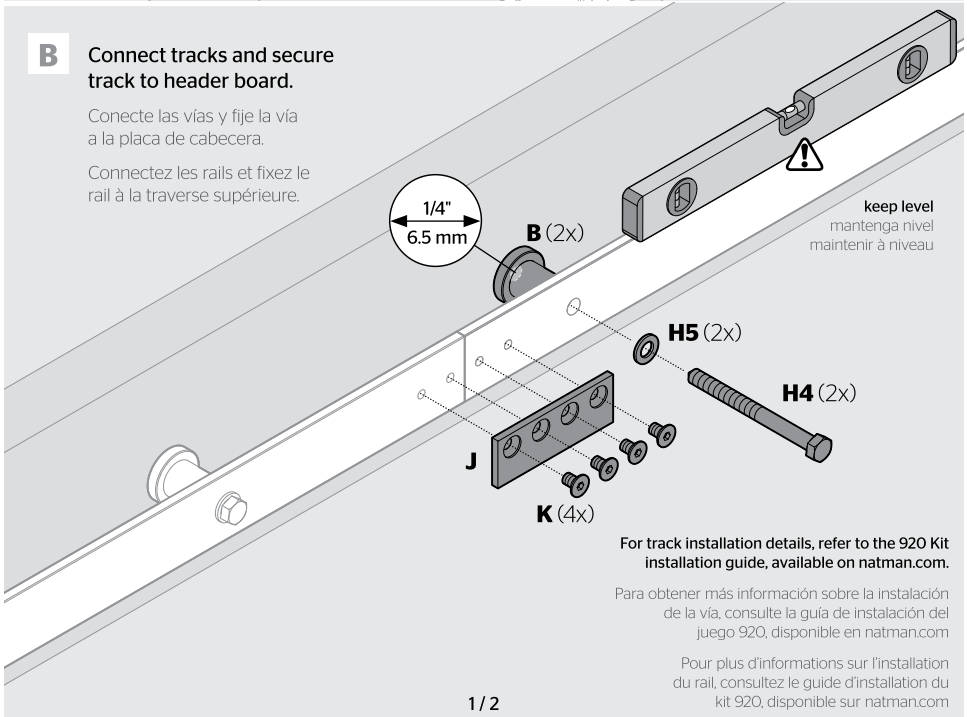

keep level
mantenga nivel
maintenir à niveau

For track installation details, refer to the 920 Kit installation guide, available on natman.com.

Para obtener más información sobre la instalación de la vía, consulte la guía de instalación del juego 920, disponible en natman.com

Pour plus d'informations sur l'installation du rail, consultez le guide d'installation du kit 920, disponible sur natman.com

C**Reinstall door stop.**

Reinstale el tope de puerta.
Reinstallez le butoir de porte.

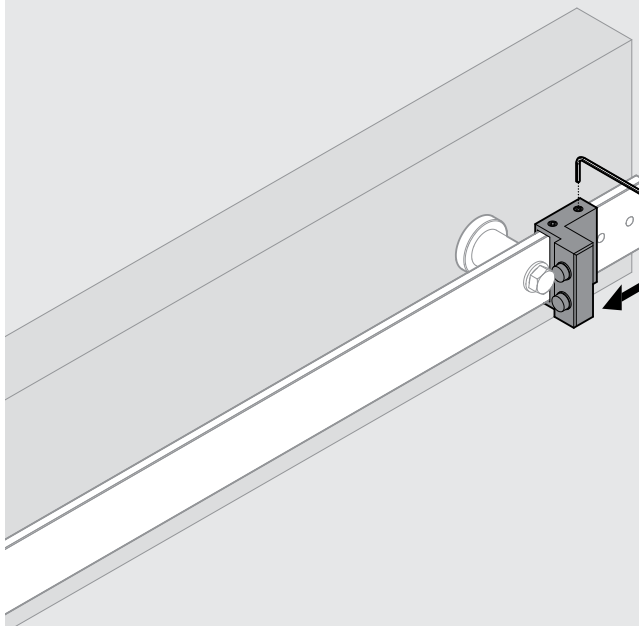
**D****Install hole caps.**

Instale los toques para orificios.
Installez les cache-trous.

