

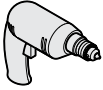

<p><b>Recommended tools</b>  <b>Herramientas recomendadas</b>  <b>Outils Recommandés</b></p> <p><b>Electric drill</b>          Taladro eléctrico          Perceuse électrique</p>  <p><b>Drill bit</b>          Broca de taladro          Mèche de perceuse 1/4" (6.5 mm)</p> 	<p><b>Wrench and socket set</b>          Juego de llave y cubo          Ensemble clés et douilles</p>  <p><b>Level</b>          Nivel          Niveau</p> 	<p><b>Parts in the box</b>  <b>Herramientas necesarias</b>  <b>Pièces dans la boîte</b></p> 
--------------------------------------------------------------------------------------------------------------------------------------------------------------------------------------------------------------------------------------------------------------------------------------------------------------------------------------------------------------------------------------------------------------------------------------------------------------------------	----------------------------------------------------------------------------------------------------------------------------------------------------------------------------------------------------------------------------------------------------------------------------------------------------------------------------------------------	---------------------------------------------------------------------------------------------------------------------------------------------------------------------------------------

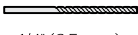
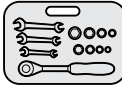

**C****Secure track to header board.**

Fije la vía a la placa de cabecera.  
Fixez le rail à la traverse supérieure.

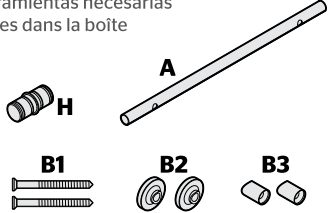
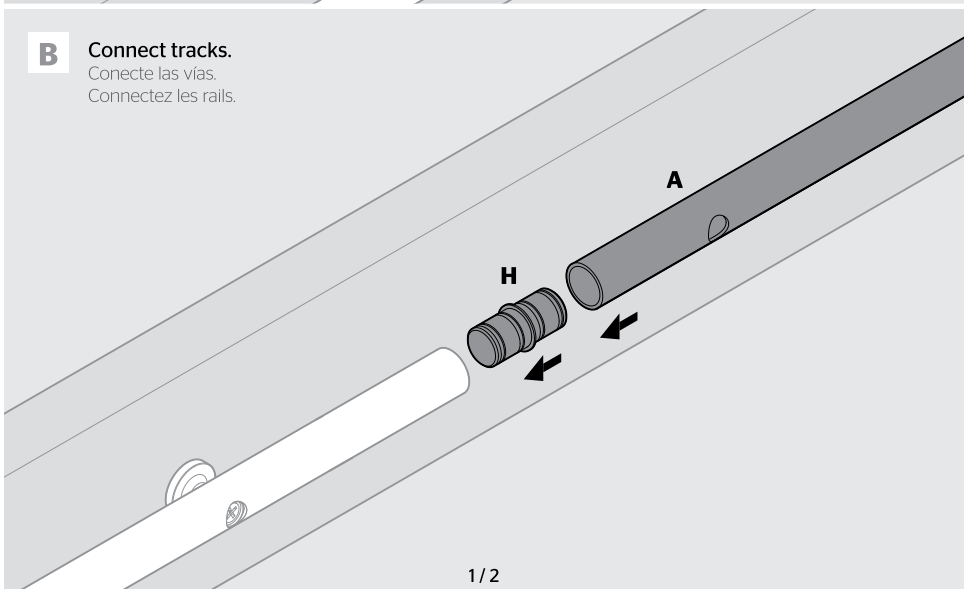
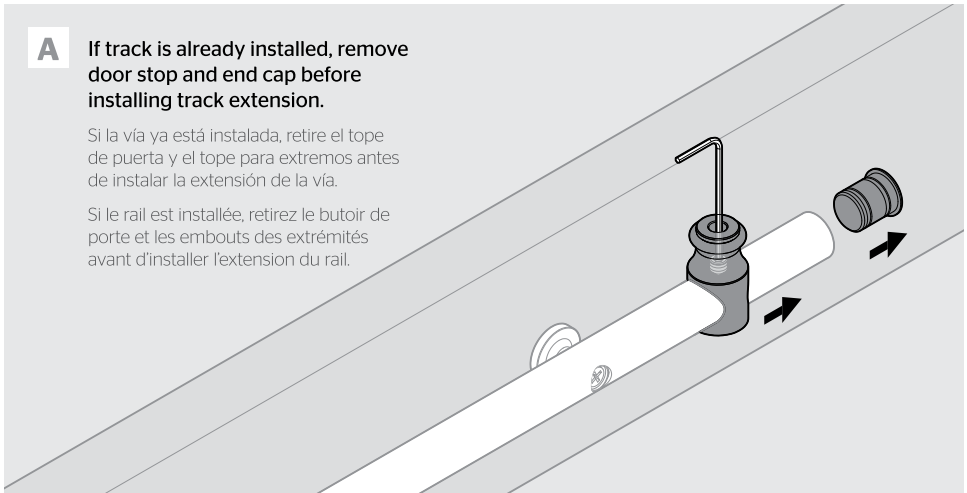
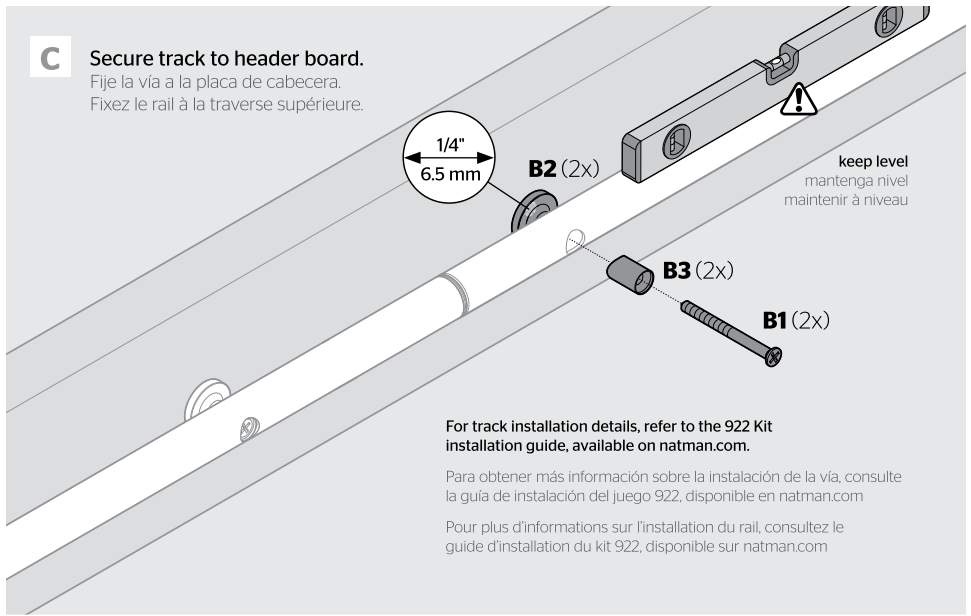
**D****Reinstall door stop.**

Reinstale el tope de puerta.  
Reinstallez le butoir de porte.

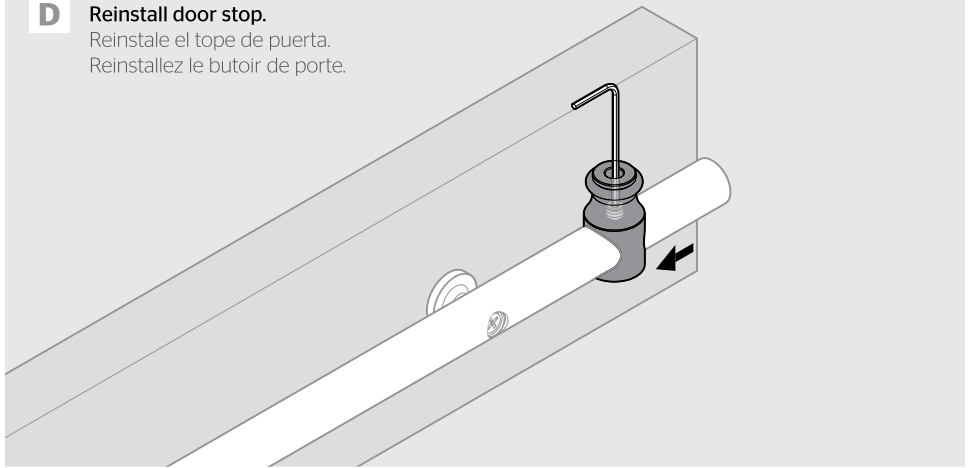
**E****Reinstall end cap.**

Reinstale los toques para extremos.  
Reinstallez les embouts des extrémités.

