

PROFIT[®]

PROFESSIONAL FIT

For over 40 years, National Nail Corp. has offered a complete line of ProFit[®] bulk & packaged nails and screws. Today, the ProFit[®] brand includes high-quality collated fasteners and the industry's preferred Platinum Series premium and composite exterior screws. They carry an exclusive lifetime warranty in ACQ and all pressure-treated lumber.



Exterior Screws..... 2



Interior Screws 13



Screw Accessories..... 18

Exterior Screws

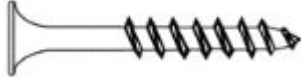
 Deck - Grey Coat Plus (Exterior Screws)						
Use for exterior deck and railing projects where rust resistance is important. Combo drive, coarse thread, bugle head, sharp point.						
Item Nbr	Description	Package Type	Weight	ACQ / CA	Count Per Lb	Brand
0285052	1" x 6 Deck Combo Drive Screw - Grey Coat	1 - 10 M Box(s)	30.05	✓	333	ProFit
0281050	1" x 6 Deck Combo Drive Screw - Grey Coat	10 - 100 ct Box(s)	2	✓	333	ProFit
0281055	1" x 6 Deck Combo Drive Screw - Grey Coat	6 - 5 lbs Box(s)	30	✓	333	ProFit
0281057	1" x 6 Deck Combo Drive Screw - Grey Coat	25 - 1 lbs Box(s)	25	✓	333	ProFit
0281075	1 1/4" x 6 Deck Combo Drive Screw - Grey Coat	6 - 5 lbs Box(s)	30	✓	285	ProFit
0281077	1 1/4" x 6 Deck Combo Drive Screw - Grey Coat	25 - 1 lbs Box(s)	25	✓	285	ProFit
0285072	1 1/4" x 6 Deck Combo Drive Screw - Grey Coat	1 - 8 M Box(s)	31.39	✓	285	ProFit
0281079	1 1/4" x 6 Deck Combo Drive Screw - Grey Coat	1 - 25 lbs Pail(s)	25	✓	285	ProFit
0281076	1 1/4" x 6 Deck Combo Drive Screw - Grey Coat	10 - 1 lbs Box(s)	10	✓	285	ProFit
0281106	1 5/8" x 6 Deck Combo Drive Screw - Grey Coat	10 - 1 lbs Box(s)	10	✓	217	ProFit
0285102	1 5/8" x 6 Deck Combo Drive Screw - Grey Coat	1 - 5 M Box(s)	24.03	✓	217	ProFit
0281100	1 5/8" x 6 Deck Combo Drive Screw - Grey Coat	10 - 65 ct Box(s)	3	✓	217	ProFit
0281105	1 5/8" x 6 Deck Combo Drive Screw - Grey Coat	6 - 5 lbs Box(s)	30	✓	217	ProFit
0281107	1 5/8" x 6 Deck Combo Drive Screw - Grey Coat	25 - 1 lbs Box(s)	25	✓	217	ProFit
0281109	1 5/8" x 6 Deck Combo Drive Screw - Grey Coat	1 - 25 lbs Pail(s)	25	✓	217	ProFit
0281139	2" x 8 Deck Combo Drive Screw - Grey Coat	1 - 25 lbs Pail(s)	25	✓	127	ProFit
0281130	2" x 8 Deck Combo Drive Screw - Grey Coat	10 - 50 ct Box(s)	3	✓	127	ProFit
0281135	2" x 8 Deck Combo Drive Screw - Grey Coat	6 - 5 lbs Box(s)	30	✓	127	ProFit
0281137	2" x 8 Deck Combo Drive Screw - Grey Coat	25 - 1 lbs Box(s)	25	✓	127	ProFit
0285132	2" x 8 Deck Combo Drive Screw - Grey Coat	1 - 3.5 M Box(s)	25.39	✓	127	ProFit
0281136	2" x 8 Deck Combo Drive Screw - Grey Coat	10 - 1 lbs Box(s)	10	✓	127	ProFit
0285152	2 1/2" x 9 Deck Combo Drive Screw - Grey Coat	1 - 2.5 M Box(s)	26.4	✓	99	ProFit
0281150	2 1/2" x 9 Deck Combo Drive Screw - Grey Coat	10 - 30 ct Box(s)	2	✓	99	ProFit
0281157	2 1/2" x 9 Deck Combo Drive Screw - Grey Coat	25 - 1 lbs Box(s)	25	✓	99	ProFit
0281159	2 1/2" x 9 Deck Combo Drive Screw - Grey Coat	1 - 25 lbs Pail(s)	25	✓	99	ProFit
0281158	2 1/2" x 9 Deck Combo Drive Screw - Grey Coat	90 - 5 lbs Box(s)	352.5	✓	99	ProFit
0281156	2 1/2" x 9 Deck Combo Drive Screw - Grey Coat	10 - 1 lbs Box(s)	10	✓	99	ProFit
0281155	2 1/2" x 9 Deck Combo Drive Screw - Grey Coat	6 - 5 lbs Box(s)	30	✓	99	ProFit
0281175	3" x 9 Deck Combo Drive Screw - Grey Coat	6 - 5 lbs Box(s)	30	✓	83	ProFit
0281177	3" x 9 Deck Combo Drive Screw - Grey Coat	25 - 1 lbs Box(s)	25	✓	83	ProFit
0281179	3" x 9 Deck Combo Drive Screw - Grey Coat	1 - 25 lbs Pail(s)	25	✓	83	ProFit
0281170	3" x 9 Deck Combo Drive Screw - Grey Coat	10 - 25 ct Box(s)	2	✓	83	ProFit
0281178	3" x 9 Deck Combo Drive Screw - Grey Coat	90 - 5 lbs Box(s)	416.25	✓	83	ProFit
0285172	3" x 9 Deck Combo Drive Screw - Grey Coat	1 - 2 M Box(s)	25.31	✓	83	ProFit
0281176	3" x 9 Deck Combo Drive Screw - Grey Coat	10 - 1 lbs Box(s)	10	✓	83	ProFit
0281196	3 1/2" x 10 Deck Combo Drive Screw - Grey Coat	10 - 1 lbs Box(s)	10	✓	55	ProFit
0281199	3 1/2" x 10 Deck Combo Drive Screw - Grey Coat	1 - 25 lbs Pail(s)	25	✓	55	ProFit
0285192	3 1/2" x 10 Deck Combo Drive Screw - Grey Coat	1 - 1 M Box(s)	18.12	✓	55	ProFit
0281197	3 1/2" x 10 Deck Combo Drive Screw - Grey Coat	25 - 1 lbs Box(s)	25	✓	55	ProFit
0281195	3 1/2" x 10 Deck Combo Drive Screw - Grey Coat	6 - 5 lbs Box(s)	30	✓	55	ProFit
0281205	4" x 10 Deck Combo Drive Screw - Grey Coat	6 - 5 lbs Box(s)	30	✓	50	ProFit
0281207	4" x 10 Deck Combo Drive Screw - Grey Coat	25 - 1 lbs Box(s)	25	✓	50	ProFit
0281209	4" x 10 Deck Combo Drive Screw - Grey Coat	1 - 25 lbs Pail(s)	25	✓	50	ProFit
0281206	4" x 10 Deck Combo Drive Screw - Grey Coat	10 - 1 lbs Box(s)	10	✓	50	ProFit
0285202	4" x 10 Deck Combo Drive Screw - Grey Coat	1 - 1 M Box(s)	20.81	✓	50	ProFit

PROFIT PROFESSIONAL FIT **Deck - Premium Bugle Head (Exterior Screws)**

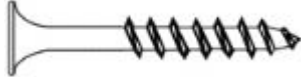

Use for exterior deck and railing projects where rust resistance is very important. Star Drive, coarse thread, bugle head, #17 point, ProTech coated for superior corrosion resistance.

Item Nbr	Description	Package Type	Weight	ACQ / CA	Count Per Lb	Brand
0333106	1 5/8" x 8 Premium Deck Screw	12 - 1 lbs Box(s)	12	✓	0	ProFit
0333102	1 5/8" x 8 Premium Deck Screw	1 - 25 lbs Box(s)	25	✓	149	ProFit
0333109	1 5/8" x 8 Premium Deck Screw	1 - 25 lbs Pail(s)	25	✓	149	ProFit
0333105	1 5/8" x 8 Premium Deck Screw	4 - 5 lbs Box(s)	20	✓	0	ProFit
0333136	2" x 8 Premium Deck Screw	12 - 1 lbs Box(s)	12	✓	0	ProFit
0333132	2" x 8 Premium Deck Screw	1 - 25 lbs Box(s)	25	✓	124	ProFit
0333139	2" x 8 Premium Deck Screw	1 - 25 lbs Pail(s)	25	✓	124	ProFit
0333135	2" x 8 Premium Deck Screw	4 - 5 lbs Box(s)	20	✓	0	ProFit
0333156	2 1/2" x 9 Premium Deck Screw	12 - 1 lbs Box(s)	12	✓	0	ProFit
0333152	2 1/2" x 9 Premium Deck Screw	1 - 25 lbs Box(s)	25	✓	96	ProFit
0333159	2 1/2" x 9 Premium Deck Screw	1 - 25 lbs Pail(s)	25	✓	96	ProFit
0333155	2 1/2" x 9 Premium Deck Screw	4 - 5 lbs Box(s)	20	✓	0	ProFit
0333176	3" x 9 Premium Deck Screw	12 - 1 lbs Box(s)	12	✓	0	ProFit
0333172	3" x 9 Premium Deck Screw	1 - 25 lbs Box(s)	25	✓	79	ProFit
0333179	3" x 9 Premium Deck Screw	1 - 25 lbs Pail(s)	25	✓	79	ProFit
0333175	3" x 9 Premium Deck Screw	4 - 5 lbs Box(s)	20	✓	0	ProFit
0333196	3 1/2" x 10 Premium Deck Screw	12 - 1 lbs Box(s)	12	✓	0	ProFit
0333192	3 1/2" x 10 Premium Deck Screw	1 - 25 lbs Box(s)	25	✓	53	ProFit
0333199	3 1/2" x 10 Premium Deck Screw	1 - 25 lbs Pail(s)	25	✓	53	ProFit
0333195	3 1/2" x 10 Premium Deck Screw	4 - 5 lbs Box(s)	20	✓	0	ProFit

PROFIT PROFESSIONAL FIT **Deck - Premium Composite (Exterior Screws)**



Use for all composite material. Star Drive, double #17 point, double thread, ProTech coated for superior corrosion resistance. Some material may require pre-drilling

Item Nbr	Description	Package Type	Weight	ACQ / CA	Count Per Lb	Brand
5340169	2 3/4" Composite Deck Screw - Cedar	1 - 25 lbs Pail(s)	25	✓	87	ProFit
5340165	2 3/4" Composite Deck Screw - Cedar	4 - 5 lbs Box(s)	20	✓	87	ProFit
4340165	2 3/4" Composite Deck Screw - Grey	4 - 5 lbs Box(s)	20	✓	87	ProFit
4340169	2 3/4" Composite Deck Screw - Grey	1 - 25 lbs Pail(s)	25	✓	87	ProFit
3340165	2 3/4" Composite Deck Screw - Tan	4 - 5 lbs Box(s)	20	✓	87	ProFit
3340169	2 3/4" Composite Deck Screw - Tan	1 - 25 lbs Pail(s)	25	✓	87	ProFit
5340179	3" Composite Deck Screw - Cedar	1 - 25 lbs Pail(s)	25	✓	79	ProFit
4340179	3" Composite Deck Screw - Grey	1 - 25 lbs Pail(s)	25	✓	79	ProFit
4340175	3" Composite Deck Screw - Grey	4 - 5 lbs Box(s)	20	✓	79	ProFit
3340175	3" Composite Deck Screw - Tan	4 - 5 lbs Box(s)	20	✓	79	ProFit
3340179	3" Composite Deck Screw - Tan	1 - 25 lbs Pail(s)	25	✓	79	ProFit

PROFIT
PROFESSIONAL FIT **Deck - Premium SS 305 Bugle Head (Exterior Screws)**

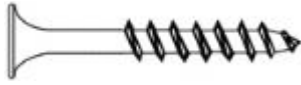

Star Drive, coarse thread, bugle head, #17 point, Stainless 305

Item Nbr	Description	Package Type	Weight	ACQ / CA	Count Per Lb	Brand
0308102	1 5/8" x 9 Stainless Steel Deck Screw	1 - 25 lbs Box(s)	25	✓	145	ProFit
0308105	1 5/8" x 9 Stainless Steel Deck Screw	4 - 5 lbs Box(s)	20	✓	145	ProFit
0308106	1 5/8" x 9 Stainless Steel Deck Screw	12 - 1 lbs Box(s)	12	✓	145	ProFit
0308135	2" x 9 Stainless Steel Deck Screw	4 - 5 lbs Box(s)	20	✓	119	ProFit
0308136	2" x 9 Stainless Steel Deck Screw	12 - 1 lbs Box(s)	12	✓	119	ProFit
0308132	2" x 9 Stainless Steel Deck Screw	1 - 25 lbs Box(s)	25	✓	119	ProFit
0308152	2 1/2" x 10 Stainless Steel Deck Screw	1 - 25 lbs Box(s)	25	✓	78	ProFit
0308155	2 1/2" x 10 Stainless Steel Deck Screw	4 - 5 lbs Box(s)	20	✓	78	ProFit
0308156	2 1/2" x 10 Stainless Steel Deck Screw	12 - 1 lbs Box(s)	12	✓	78	ProFit
0308175	3" x 10 Stainless Steel Deck Screw	4 - 5 lbs Box(s)	20	✓	64	ProFit
0308172	3" x 10 Stainless Steel Deck Screw	1 - 25 lbs Box(s)	25	✓	64	ProFit
0308176	3" x 10 Stainless Steel Deck Screw	12 - 1 lbs Box(s)	12	✓	64	ProFit
0308195	3 1/2" x 10 Stainless Steel Deck Screw	4 - 5 lbs Box(s)	20	✓	53	ProFit
0308196	3 1/2" x 10 Stainless Steel Deck Screw	12 - 1 lbs Box(s)	12	✓	53	ProFit
0308192	3 1/2" x 10 Stainless Steel Deck Screw	1 - 25 lbs Box(s)	25	✓	53	ProFit

PROFIT
PROFESSIONAL FIT **Deck - Premium SS 305 Trim Head (Exterior Screws)**



Star Drive, coarse thread, trim head, #17 point, Stainless 305

Item Nbr	Description	Package Type	Weight	ACQ / CA	Count Per Lb	Brand
0310102	1 5/8" x 8 Stainless Steel Trim Head Screw	1 - 25 lbs Box(s)	25	✓	195	ProFit
0310105	1 5/8" x 8 Stainless Steel Trim Head Screw	4 - 5 lbs Box(s)	20	✓	195	ProFit
0310106	1 5/8" x 8 Stainless Steel Trim Head Screw	12 - 1 lbs Box(s)	12	✓	195	ProFit
0310102B	1 5/8" x 8 Stainless Steel Trim Head Screw	1 - 25 lbs Box(s)	25	✓	195	ProFit
0310155	2 1/2" x 8 Stainless Steel Trim Head Screw	4 - 5 lbs Box(s)	20	✓	124	ProFit
0310156	2 1/2" x 8 Stainless Steel Trim Head Screw	12 - 1 lbs Box(s)	12	✓	124	ProFit
0310152	2 1/2" x 8 Stainless Steel Trim Head Screw	1 - 25 lbs Box(s)	25	✓	124	ProFit
0310175	3" x 8 Stainless Steel Trim Head Screw	4 - 5 lbs Box(s)	20	✓	103	ProFit
0310176	3" x 8 Stainless Steel Trim Head Screw	12 - 1 lbs Box(s)	12	✓	103	ProFit
0310172	3" x 8 Stainless Steel Trim Head Screw	1 - 25 lbs Box(s)	25	✓	103	ProFit

PROFIT PROFESSIONAL FIT **Deck - Premium SS 316 Bugle Head (Exterior Screws)**

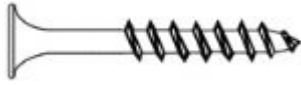

Star Drive, coarse thread, bugle head, #17 point, Stainless 316

Item Nbr	Description	Package Type	Weight	ACQ / CA	Count Per Lb	Brand
0308106S	1 5/8" x 9 Stainless Steel Deck Screw	12 - 1 lbs Box(s)	12	✓	145	ProFit
0308105S	1 5/8" x 9 Stainless Steel Deck Screw	4 - 5 lbs Box(s)	20	✓	145	ProFit
0308102S	1 5/8" x 9 Stainless Steel Deck Screw	1 - 25 lbs Box(s)	25	✓	145	ProFit
0308109S	1 5/8" x 9 Stainless Steel Deck Screw	1 - 25 lbs Pail(s)	25	✓	145	ProFit
0308139S	2" x 9 Stainless Steel Deck Screw	1 - 25 lbs Pail(s)	25	✓	119	ProFit
0308135S	2" x 9 Stainless Steel Deck Screw	4 - 5 lbs Box(s)	20	✓	119	ProFit
0308136S	2" x 9 Stainless Steel Deck Screw	12 - 1 lbs Box(s)	12	✓	119	ProFit
0308132S	2" x 9 Stainless Steel Deck Screw	1 - 25 lbs Box(s)	25	✓	119	ProFit
0308152S	2 1/2" x 10 Stainless Steel Deck Screw	1 - 25 lbs Box(s)	25	✓	78	ProFit
0308155S	2 1/2" x 10 Stainless Steel Deck Screw	4 - 5 lbs Box(s)	20	✓	78	ProFit
0308156S	2 1/2" x 10 Stainless Steel Deck Screw	12 - 1 lbs Box(s)	12	✓	78	ProFit
0308159S	2 1/2" x 10 Stainless Steel Deck Screw	1 - 25 lbs Pail(s)	25	✓	78	ProFit
0308175S	3" x 10 Stainless Steel Deck Screw	4 - 5 lbs Box(s)	20	✓	64	ProFit
0308172S	3" x 10 Stainless Steel Deck Screw	1 - 25 lbs Box(s)	25	✓	64	ProFit
0308176S	3" x 10 Stainless Steel Deck Screw	12 - 1 lbs Box(s)	12	✓	64	ProFit
0308179S	3" x 10 Stainless Steel Deck Screw	1 - 25 lbs Pail(s)	25	✓	64	ProFit
0308199S	3 1/2" x 10 Stainless Steel Deck Screw	1 - 25 lbs Pail(s)	25	✓	53	ProFit
0308195S	3 1/2" x 10 Stainless Steel Deck Screw	4 - 5 lbs Box(s)	20	✓	53	ProFit
0308196S	3 1/2" x 10 Stainless Steel Deck Screw	12 - 1 lbs Box(s)	12	✓	53	ProFit
0308192S	3 1/2" x 10 Stainless Steel Deck Screw	1 - 25 lbs Box(s)	25	✓	53	ProFit

PROFIT PROFESSIONAL FIT **Deck - Premium SS 316 Trim Head (Exterior Screws)**



Star Drive, coarse thread, trim head, #17 point, Stainless 316

Item Nbr	Description	Package Type	Weight	ACQ / CA	Count Per Lb	Brand
0310102S	1 5/8" x 8 Stainless Steel Trim Head Screw	1 - 25 lbs Box(s)	25	✓	195	ProFit
0310106S	1 5/8" x 8 Stainless Steel Trim Head Screw	12 - 1 lbs Box(s)	12	✓	195	ProFit
0310105S	1 5/8" x 8 Stainless Steel Trim Head Screw	4 - 5 lbs Box(s)	20	✓	195	ProFit
0310109S	1 5/8" x 8 Stainless Steel Trim Head Screw	1 - 25 lbs Pail(s)	25	✓	195	ProFit
0310159S	2 1/2" x 8 Stainless Steel Trim Head Screw	1 - 25 lbs Pail(s)	25	✓	124	ProFit
0310155S	2 1/2" x 8 Stainless Steel Trim Head Screw	4 - 5 lbs Box(s)	20	✓	124	ProFit
0310156S	2 1/2" x 8 Stainless Steel Trim Head Screw	12 - 1 lbs Box(s)	12	✓	124	ProFit
0310152S	2 1/2" x 8 Stainless Steel Trim Head Screw	1 - 25 lbs Box(s)	25	✓	124	ProFit
0310172S	3" x 8 Stainless Steel Trim Head Screw	1 - 25 lbs Box(s)	25	✓	103	ProFit
0310175S	3" x 8 Stainless Steel Trim Head Screw	4 - 5 lbs Box(s)	20	✓	103	ProFit
0310176S	3" x 8 Stainless Steel Trim Head Screw	12 - 1 lbs Box(s)	12	✓	103	ProFit
0310179S	3" x 8 Stainless Steel Trim Head Screw	1 - 25 lbs Pail(s)	25	✓	103	ProFit

PROFIT
PROFESSIONAL FIT **Deck - Premium Structural (Exterior Screws)**



Use for exterior projects in place of lag bolts without pre-drilling. Large washer head, T40 star drive, ProTech coated for superior corrosion resistance.

Item Nbr	Description	Package Type	Weight	ACQ / CA	Count Per Lb	Brand
0339209	4" Structural Screw	1 - 25 lbs Pail(s)	25	✓	22	ProFit
0339204	4" Structural Screw	4 - 50 ct Box(s)	19.6	✓	22	ProFit
0339200	4" Structural Screw	10 - 10 ct Box(s)	9.8	✓	22	ProFit
0339240	6" Structural Screw	10 - 10 ct Box(s)	13.72	✓	15	ProFit
0339244	6" Structural Screw	4 - 50 ct Box(s)	27.44	✓	15	ProFit
0339249	6" Structural Screw	1 - 25 lbs Pail(s)	25	✓	15	ProFit
0339269	8" Landscape Screw	1 - 250 ct Pail(s)	22.05	✓	12	ProFit
0339279	10" Landscape Screw	1 - 250 ct Pail(s)	26.95	✓	10	ProFit

PROFIT
PROFESSIONAL FIT **Deck - Premium Trim Head (Exterior Screws)**



Star Drive, coarse thread, trim head, #17 point, ProTech coated for superior corrosion resistance.

Item Nbr	Description	Package Type	Weight	ACQ / CA	Count Per Lb	Brand
0332109	1 5/8" x 7 Premium ProTech Trim Head Deck	1 - 25 lbs Pail(s)	25	✓	203	ProFit
0332105	1 5/8" x 7 Premium ProTech Trim Head Deck	4 - 5 lbs Box(s)	20	✓	203	ProFit
0332106	1 5/8" x 7 Premium ProTech Trim Head Deck	12 - 1 lbs Box(s)	12	✓	203	ProFit
0332102	1 5/8" x 7 Premium ProTech Trim Head Deck	1 - 25 lbs Box(s)	25	✓	203	ProFit
0332159	2 1/2" x 7 Premium ProTech Trim Head Deck	1 - 25 lbs Pail(s)	25	✓	130	ProFit
0332152	2 1/2" x 7 Premium ProTech Trim Head Deck	1 - 25 lbs Box(s)	25	✓	130	ProFit
0332155	2 1/2" x 7 Premium ProTech Trim Head Deck	4 - 5 lbs Box(s)	20	✓	130	ProFit
0332156	2 1/2" x 7 Premium ProTech Trim Head Deck	12 - 1 lbs Box(s)	12	✓	130	ProFit
0332175	3" x 7 Premium ProTech Trim Head Deck	4 - 5 lbs Box(s)	20	✓	107	ProFit
0332176	3" x 7 Premium ProTech Trim Head Deck	12 - 1 lbs Box(s)	12	✓	107	ProFit
0332172	3" x 7 Premium ProTech Trim Head Deck	1 - 25 lbs Box(s)	25	✓	107	ProFit
0332179	3" x 7 Premium ProTech Trim Head Deck	1 - 25 lbs Pail(s)	25	✓	107	ProFit

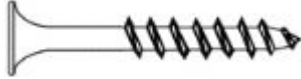
		Deck - Silver Dacrotized (Exterior Screws)				
						
Use for exterior projects where rust resistance is not as important, Philips drive, coarse thread, bugle head, sharp point						
Item Nbr	Description	Package Type	Weight	ACQ / CA	Count Per Lb	Brand
0282055	1" x 6 Silver Dacro Exterior Screw	6 - 5 lbs Box(s)	30	No	333	ProFit
0282057	1" x 6 Silver Dacro Exterior Screw	25 - 1 lbs Box(s)	25	No	333	ProFit
0284052	1" x 6 Silver Dacro Exterior Screw	1 - 10 M Box(s)	31.53	No	333	ProFit
0282059	1" x 6 Silver Dacro Exterior Screw	1 - 25 lbs Pail(s)	25	No	333	ProFit
0282050	1" x 6 Silver Dacro Exterior Screw	10 - 100 ct Box(s)	2	No	333	ProFit
0282075	1 1/4" x 6 Silver Dacro Exterior Screw	6 - 5 lbs Box(s)	30	No	285	ProFit
0282079	1 1/4" x 6 Silver Dacro Exterior Screw	1 - 25 lbs Pail(s)	25	No	285	ProFit
0284072	1 1/4" x 6 Silver Dacro Exterior Screw	1 - 8 M Box(s)	30.69	No	285	ProFit
0282076	1 1/4" x 6 Silver Dacro Exterior Screw	10 - 1 lbs Box(s)	10	No	285	ProFit
0282077	1 1/4" x 6 Silver Dacro Exterior Screw	25 - 1 lbs Box(s)	25	No	285	ProFit
0282106	1 5/8" x 6 Silver Dacro Exterior Screw	10 - 1 lbs Box(s)	10	No	217	ProFit
0284102	1 5/8" x 6 Silver Dacro Exterior Screw	1 - 5 M Box(s)	23.92	No	217	ProFit
0282105	1 5/8" x 6 Silver Dacro Exterior Screw	6 - 5 lbs Box(s)	30	No	217	ProFit
0282109	1 5/8" x 6 Silver Dacro Exterior Screw	1 - 25 lbs Pail(s)	25	No	217	ProFit
0282107	1 5/8" x 6 Silver Dacro Exterior Screw	25 - 1 lbs Box(s)	25	No	217	ProFit
0282100	1 5/8" x 6 Silver Dacro Exterior Screw	10 - 65 ct Box(s)	3	No	217	ProFit
0282136	2" x 7 Silver Dacro Exterior Screw	10 - 1 lbs Box(s)	10	No	175	ProFit
0282137	2" x 7 Silver Dacro Exterior Screw	25 - 1 lbs Box(s)	25	No	175	ProFit
0284132	2" x 7 Silver Dacro Exterior Screw	1 - 3.5 M Box(s)	23.53	No	175	ProFit
0282139	2" x 7 Silver Dacro Exterior Screw	1 - 25 lbs Pail(s)	25	No	175	ProFit
0282135	2" x 7 Silver Dacro Exterior Screw	6 - 5 lbs Box(s)	30	No	175	ProFit
0282130	2" x 7 Silver Dacro Exterior Screw	10 - 50 ct Box(s)	3	No	175	ProFit
0282155	2 1/2" x 8 Silver Dacro Exterior Screw	6 - 5 lbs Box(s)	30	No	119	ProFit
0282157	2 1/2" x 8 Silver Dacro Exterior Screw	25 - 1 lbs Box(s)	25	No	119	ProFit
0282156	2 1/2" x 8 Silver Dacro Exterior Screw	10 - 1 lbs Box(s)	10	No	119	ProFit
0284152	2 1/2" x 8 Silver Dacro Exterior Screw	1 - 2.5 M Box(s)	22.87	No	119	ProFit
0282159	2 1/2" x 8 Silver Dacro Exterior Screw	1 - 25 lbs Pail(s)	25	No	119	ProFit
0282150	2 1/2" x 8 Silver Dacro Exterior Screw	10 - 30 ct Box(s)	2	No	119	ProFit
0282179	3" x 8 Silver Dacro Exterior Screw	1 - 25 lbs Pail(s)	25	No	90	ProFit
0284172	3" x 8 Silver Dacro Exterior Screw	1 - 2 M Box(s)	22.05	No	90	ProFit
0282176	3" x 8 Silver Dacro Exterior Screw	10 - 1 lbs Box(s)	10	No	90	ProFit
0282175	3" x 8 Silver Dacro Exterior Screw	6 - 5 lbs Box(s)	30	No	90	ProFit
0282177	3" x 8 Silver Dacro Exterior Screw	25 - 1 lbs Box(s)	25	No	90	ProFit
0282170	3" x 8 Silver Dacro Exterior Screw	10 - 25 ct Box(s)	3	No	90	ProFit
0282195	3 1/2" x 10 Silver Dacro Exterior Screw	6 - 5 lbs Box(s)	30	No	55	ProFit
0282197	3 1/2" x 10 Silver Dacro Exterior Screw	25 - 1 lbs Box(s)	25	No	55	ProFit
0282196	3 1/2" x 10 Silver Dacro Exterior Screw	10 - 1 lbs Box(s)	10	No	55	ProFit
0282199	3 1/2" x 10 Silver Dacro Exterior Screw	1 - 25 lbs Pail(s)	25	No	55	ProFit
0284192	3 1/2" x 10 Silver Dacro Exterior Screw	1 - 1 M Box(s)	17.86	No	55	ProFit
0282205	4" x 10 Silver Dacro Exterior Screw	6 - 5 lbs Box(s)	30	No	50	ProFit
0282209	4" x 10 Silver Dacro Exterior Screw	1 - 25 lbs Pail(s)	25	No	50	ProFit
0284202	4" x 10 Silver Dacro Exterior Screw	1 - 1 M Box(s)	20.13	No	50	ProFit
0282207	4" x 10 Silver Dacro Exterior Screw	25 - 1 lbs Box(s)	25	No	50	ProFit

PROFIT
PROFESSIONAL FIT **Post Frame Screw Self Pierce Black 900 (Exterior Screws)**



Used to fasten steel roofing and siding and color matched to the steel

Item Nbr	Description	Package Type	Weight	ACQ / CA	Count Per Lb	Brand
0270054	1" Post Frame Screws Black Self Piercing	1 - 4 M Box(s)	36	✓	155	ProFit
0270094	1 1/2" Post Frame Screws Black Self Piercing	1 - 3 M Box(s)	34	✓	116	ProFit
0270134	2" Post Frame Screws Black Self Piercing	1 - 2 M Box(s)	28	✓	88	ProFit
0270154	2 1/2" Post Frame Screws Black Self Piercing	1 - 2 M Box(s)	32	✓	75	ProFit
0270156	2 1/2" Post Frame Screws Black Self Piercing	6 - 250 ct Box(s)	23	✓	75	ProFit
0270174	3" Post Frame Screws Black Self Piercing	1 - 2 M Box(s)	30	✓	65	ProFit
0270176	3" Post Frame Screws Black Self Piercing	6 - 250 ct Box(s)	26	✓	65	ProFit

PROFIT
PROFESSIONAL FIT **Post Frame Screw Self Pierce Brt Red 201 (Exterior Screws)**



Used to fasten steel roofing and siding and color matched to the steel

Item Nbr	Description	Package Type	Weight	ACQ / CA	Count Per Lb	Brand
0268094	1 1/2" Post Frame Screws Bright Red Self Piercing	1 - 3 M Box(s)	34	✓	116	ProFit
0268134	2" Post Frame Screws Bright Red Self Piercing	1 - 2 M Box(s)	28	✓	88	ProFit

PROFIT
PROFESSIONAL FIT **Post Frame Screw Self Pierce Brt Wht 613 (Exterior Screws)**



Used to fasten steel roofing and siding and color matched to the steel

Item Nbr	Description	Package Type	Weight	ACQ / CA	Count Per Lb	Brand
0269094	1 1/2" Post Frame Screw Brite White Self Piercing	1 - 3 M Box(s)	34	✓	116	ProFit

PROFIT
PROFESSIONAL FIT **Post Frame Screw Self Pierce Cocoa 300** (Exterior Screws)



Used to fasten steel roofing and siding and color matched to the steel

Item Nbr	Description	Package Type	Weight	ACQ / CA	Count Per Lb	Brand
0273054	1" Post Frame Screws Cocoa Brown Self Piercing	1 - 4 M Box(s)	32.4	✓	155	ProFit
0273056	1" Post Frame Screws Cocoa Brown Self Piercing	6 - 250 ct Box(s)	12.15	✓	155	ProFit
0273094	1 1/2" Post Frame Screws Cocoa Brown Self Piercing	1 - 3 M Box(s)	30.6	✓	116	ProFit
0273096	1 1/2" Post Frame Screws Cocoa Brown Self Piercing	6 - 250 ct Box(s)	15.3	✓	116	ProFit
0273134	2" Post Frame Screws Cocoa Brown Self Piercing	1 - 2 M Box(s)	25	✓	88	ProFit
0273136	2" Post Frame Screws Cocoa Brown Self Piercing	6 - 250 ct Box(s)	18.75	✓	88	ProFit
0273156	2 1/2" Post Frame Screws Cocoa Brown Self Piercing	6 - 250 ct Box(s)	23	✓	75	ProFit
0273154	2 1/2" Post Frame Screws Cocoa Brown Self Piercing	1 - 2 M Box(s)	32	✓	75	ProFit
0273174	3" Post Frame Screws Cocoa Brown Self Piercing	1 - 2 M Box(s)	30	✓	65	ProFit
0273176	3" Post Frame Screws Cocoa Brown Self Piercing	6 - 250 ct Box(s)	26	✓	65	ProFit

PROFIT
PROFESSIONAL FIT **Post Frame Screw Self Pierce Dk Brn 301** (Exterior Screws)



Used to fasten steel roofing and siding and color matched to the steel

Item Nbr	Description	Package Type	Weight	ACQ / CA	Count Per Lb	Brand
0275134	2" Post Frame Screws Brown Self Piercing	1 - 2 M Box(s)	0	✓	88	ProFit

PROFIT
PROFESSIONAL FIT **Post Frame Screw Self Pierce Evergrn 400** (Exterior Screws)



Used to fasten steel roofing and siding and color matched to the steel

Item Nbr	Description	Package Type	Weight	ACQ / CA	Count Per Lb	Brand
0264056	1" Post Frame Screws Evergreen Self Piercing	6 - 250 ct Box(s)	12.15	✓	155	ProFit
0264054	1" Post Frame Screws Evergreen Self Piercing	1 - 4 M Box(s)	32.4	✓	155	ProFit
0264094	1 1/2" Post Frame Screws Evergreen Self Piercing	1 - 3 M Box(s)	30.6	✓	116	ProFit
0264096	1 1/2" Post Frame Screws Evergreen Self Piercing	6 - 250 ct Box(s)	15.3	✓	116	ProFit
0264134	2" Post Frame Screws Evergreen Self Piercing	1 - 2 M Box(s)	25	✓	88	ProFit
0264136	2" Post Frame Screws Evergreen Self Piercing	6 - 250 ct Box(s)	18.75	✓	88	ProFit
0264154	2 1/2" Post Frame Screws Evergreen Self Piercing	1 - 2 M Box(s)	32	✓	75	ProFit
0264156	2 1/2" Post Frame Screws Evergreen Self Piercing	6 - 250 ct Box(s)	23	✓	75	ProFit
0264174	3" Post Frame Screws Evergreen Self Piercing	1 - 2 M Box(s)	30	✓	65	ProFit
0264176	3" Post Frame Screws Evergreen Self Piercing	6 - 250 ct Box(s)	26	✓	65	ProFit

PROFIT
PROFESSIONAL FIT **Post Frame Screw Self Pierce Galv. (Exterior Screws)**



Used to fasten steel roofing and siding

Item Nbr	Description	Package Type	Weight	ACQ / CA	Count Per Lb	Brand
0276034	3/4" X 14 Goof & Stitch Galvanized Self Piercing	1 - 500 ct Box(s)	5	✓	0	ProFit
0278055	1" Post Frame Galvanized Self Pierce Screw	6 - 5 lbs Box(s)	30	✓	155	ProFit
0278057	1" Post Frame Galvanized Self Pierce Screw	25 - 1 lbs Box(s)	25	✓	155	ProFit
0278056	1" Post Frame Galvanized Self Pierce Screw	6 - 250 ct Box(s)	12.15	✓	155	ProFit
0278054	1" Post Frame Galvanized Self Pierce Screw	1 - 4 M Box(s)	32.4	✓	155	ProFit
0278096	1 1/2" Post Frame Galvanized Self Pierce Screw	6 - 250 ct Box(s)	15.3	✓	116	ProFit
0278095	1 1/2" Post Frame Galvanized Self Pierce Screw	6 - 5 lbs Box(s)	30	✓	116	ProFit
0278097	1 1/2" Post Frame Galvanized Self Pierce Screw	25 - 1 lbs Box(s)	25	✓	116	ProFit
0278091	1 1/2" Post Frame Galvanized Self Pierce Screw	1 - 1 M Box(s)	10.2	✓	116	ProFit
0278094	1 1/2" Post Frame Galvanized Self Pierce Screw	1 - 3 M Box(s)	30.6	✓	116	ProFit
0278135	2" Post Frame Galvanized Self Pierce Screw	6 - 5 lbs Box(s)	30	✓	88	ProFit
0278137	2" Post Frame Galvanized Self Pierce Screw	25 - 1 lbs Box(s)	25	✓	88	ProFit
0278136	2" Post Frame Galvanized Self Pierce Screw	6 - 250 ct Box(s)	18.75	✓	88	ProFit
0278134	2" Post Frame Galvanized Self Pierce Screw	1 - 2 M Box(s)	25	✓	88	ProFit
0278154	2 1/2" Post Frame Galvanized Self Pierce Screw	1 - 2 M Box(s)	29	✓	75	ProFit
0278156	2 1/2" Post Frame Galvanized Self Pierce Screw	6 - 250 ct Box(s)	21.75	✓	75	ProFit
0278155	2 1/2" Post Frame Galvanized Self Pierce Screw	6 - 5 lbs Box(s)	30	✓	75	ProFit
0278157	2 1/2" Post Frame Galvanized Self Pierce Screw	25 - 1 lbs Box(s)	25	✓	75	ProFit
0278176	3" Post Frame Galvanized Self Pierce Screw	6 - 250 ct Box(s)	26.25	✓	65	ProFit
0278174	3" Post Frame Galvanized Self Pierce Screw	1 - 2 M Box(s)	35	✓	65	ProFit

PROFIT
PROFESSIONAL FIT **Post Frame Screw Self Pierce Lt Blue 700 (Exterior Screws)**



Used to fasten steel roofing and siding and color matched to the steel

Item Nbr	Description	Package Type	Weight	ACQ / CA	Count Per Lb	Brand
0296056	1" Post Frame Screws Lt Blue Self Piercing	6 - 250 ct Box(s)	30	✓	155	ProFit
0296094	1 1/2" Post Frame Screws Lt Blue Self Piercing	1 - 3 M Box(s)	30.6	✓	116	ProFit
0296095	1 1/2" Post Frame Screws Lt Blue Self Piercing	6 - 5 lbs Box(s)	30	✓	116	ProFit
0296097	1 1/2" Post Frame Screws Lt Blue Self Piercing	25 - 1 lbs Box(s)	25	✓	116	ProFit
0296136	2" Post Frame Screws Lt Blue Self Piercing	6 - 250 ct Box(s)	30	✓	88	ProFit

PROFIT
PROFESSIONAL FIT **Post Frame Screw Self Pierce Lt Stn 602 (Exterior Screws)**



Used to fasten steel roofing and siding and color matched to the steel

Item Nbr	Description	Package Type	Weight	ACQ / CA	Count Per Lb	Brand
0267094	1 1/2" Post Frame Screws Lt Stone Self Piercing	1 - 3 M Box(s)	30.6	✓	116	ProFit
0267096	1 1/2" Post Frame Screws Lt Stone Self Piercing	6 - 250 ct Box(s)	15.3	✓	116	ProFit
0267154	2 1/2" Post Frame Screws Lt Stone Self Piercing	1 - 2 M Box(s)	32	✓	75	ProFit

PROFIT
PROFESSIONAL FIT **Post Frame Screw Self Pierce Red 200 (Exterior Screws)**



Used to fasten steel roofing and siding and color matched to the steel

Item Nbr	Description	Package Type	Weight	ACQ / CA	Count Per Lb	Brand
0274057	1" Post Frame Screws Red Self Piercing	25 - 1 lbs Box(s)	25	✓	155	ProFit
0274055	1" Post Frame Screws Red Self Piercing	6 - 5 lbs Box(s)	30	✓	155	ProFit
0274054	1" Post Frame Screws Red Self Piercing	1 - 4 M Box(s)	32.4	✓	155	ProFit
0274056	1" Post Frame Screws Red Self Piercing	6 - 250 ct Box(s)	12.15	✓	155	ProFit
0274094	1 1/2" Post Frame Screws Red Self Piercing	1 - 3 M Box(s)	30.6	✓	116	ProFit
0274096	1 1/2" Post Frame Screws Red Self Piercing	6 - 250 ct Box(s)	15.3	✓	116	ProFit
0274095	1 1/2" Post Frame Screws Red Self Piercing	6 - 5 lbs Box(s)	30	✓	116	ProFit
0274097	1 1/2" Post Frame Screws Red Self Piercing	25 - 1 lbs Box(s)	25	✓	116	ProFit
0274134	2" Post Frame Screws Red Self Piercing	1 - 2 M Box(s)	25	✓	88	ProFit
0274136	2" Post Frame Screws Red Self Piercing	6 - 250 ct Box(s)	18.75	✓	88	ProFit
0274154	2 1/2" Post Frame Screws Red Self Piercing	1 - 2 M Box(s)	32	✓	75	ProFit
0274156	2 1/2" Post Frame Screws Red Self Piercing	6 - 250 ct Box(s)	23	✓	75	ProFit
0274174	3" Post Frame Screws Red Self Piercing	1 - 2 M Box(s)	0	✓	65	ProFit

PROFIT
PROFESSIONAL FIT **Post Frame Screw Self Pierce Tan 600 (Exterior Screws)**



Used to fasten steel roofing and siding and color matched to the steel

Item Nbr	Description	Package Type	Weight	ACQ / CA	Count Per Lb	Brand
0272056	1" Post Frame Screws Tan Self Piercing	6 - 250 ct Box(s)	13.5	✓	155	ProFit
0272054	1" Post Frame Screws Tan Self Piercing	1 - 4 M Box(s)	36	✓	155	ProFit
0272094	1 1/2" Post Frame Screws Tan Self Piercing	1 - 3 M Box(s)	30.6	✓	116	ProFit
0272096	1 1/2" Post Frame Screws Tan Self Piercing	6 - 250 ct Box(s)	15.3	✓	116	ProFit
0272136	2" Post Frame Screws Tan Self Piercing	6 - 250 ct Box(s)	21	✓	88	ProFit
0272134	2" Post Frame Screws Tan Self Piercing	1 - 2 M Box(s)	28	✓	88	ProFit
0272154	2 1/2" Post Frame Screws Tan Self Piercing	1 - 2 M Box(s)	32	✓	75	ProFit

PROFIT
PROFESSIONAL FIT **Post Frame Screw Self Pierce White 100** (Exterior Screws)



Used to fasten steel roofing and siding and color matched to the steel

Item Nbr	Description	Package Type	Weight	ACQ / CA	Count Per Lb	Brand
0277034	3/4" X 14 Goof & Stitch White Self Pierce	1 - 500 CT Box(s)	5	✓	0	ProFit
0279055	1" Post Frame Screw White Self Pierce	6 - 5 lbs Box(s)	30	✓	155	ProFit
0279057	1" Post Frame Screw White Self Piercing	25 - 1 lbs Box(s)	25	✓	155	ProFit
0279054	1" Post Frame Screw White Self Piercing	1 - 4 M Box(s)	32.4	✓	155	ProFit
0279056	1" Post Frame Screws White Piercing	6 - 250 ct Box(s)	12.15	✓	155	ProFit
0279096	1 1/2" Post Frame Screw White Self Piercing	6 - 250 ct Box(s)	15.3	✓	116	ProFit
0279094	1 1/2" Post Frame Screw White Self Piercing	1 - 3 M Box(s)	30.6	✓	116	ProFit
0279091	1-1/2" Post Frame Screws White Self Piercing	1 - 1 M Box(s)	10.2	✓	116	ProFit
0279099	1-1/2" Post Frame White Self Piercing	1 - 2500 ct Pail(s)	29.6	✓	116	ProFit
0279136	2" Post Frame Screws White Self Piercing	6 - 250 ct Box(s)	18.75	✓	88	ProFit
0279134	2" Post Frame Screws White Self Piercing	1 - 2 M Box(s)	25	✓	88	ProFit
0279135	2" Post Frame Screws White Self Piercing	6 - 5 lbs Box(s)	30	✓	88	ProFit
0279137	2" Post Frame Screws White Self Piercing	25 - 1 lbs Box(s)	25	✓	88	ProFit
0279155	2 1/2" Post Frame Screws White Self Piercing	6 - 5 lbs Box(s)	30	✓	75	ProFit
0279154	2 1/2" Post Frame Screws White Self Piercing	1 - 2 M Box(s)	29	✓	75	ProFit
0279156	2 1/2" Post Frame Screws White Self Piercing	6 - 250 ct Box(s)	21.75	✓	75	ProFit
0279157	2 1/2" Post Frame Screws White Self Piercing	25 - 1 lbs Box(s)	25	✓	75	ProFit
0279174	3" Post Frame Screws White Self Piercing	1 - 2 M Box(s)	35	✓	65	ProFit
0279176	3" Post Frame Screws White Self Piercing	6 - 250 ct Box(s)	17	✓	65	ProFit

PROFIT
PROFESSIONAL FIT **Post Frame Screw Self Pierce YT Grey 906** (Exterior Screws)



Used to fasten steel roofing and siding and color matched to the steel

Item Nbr	Description	Package Type	Weight	ACQ / CA	Count Per Lb	Brand
0299134	2" Post Frame Screws Quaker Grey Self Piercing	1 - 2 M Box(s)	28	✓	88	ProFit

PROFIT
PROFESSIONAL FIT **Post Frame Screw Self Pierce Zn Grey 904** (Exterior Screws)



Used to fasten steel roofing and siding and color matched to the steel

Item Nbr	Description	Package Type	Weight	ACQ / CA	Count Per Lb	Brand
0271094	1 1/2" Post Frame Screws Zinc Grey Self Piercing	1 - 3 M Box(s)	30.6	✓	116	ProFit
0271096	1 1/2" Post Frame Screws Zinc Grey Self Piercing	6 - 250 ct Box(s)	15.3	✓	116	ProFit
0271134	2" Post Frame Screws Zinc Grey Self Piercing	1 - 2 M Box(s)	3.4	✓	88	ProFit
0271154	2 1/2" Post Frame Screws Zinc Grey Self Piercing	1 - 2 M Box(s)	32	✓	75	ProFit
0297174	3" Post Frame Screws Zinc Grey Self Piercing	1 - 2 M Box(s)	7	✓	65	ProFit

Interior Screws

PROFIT
PROFESSIONAL FIT **Cabinet Screws Gold (Combo) (Interior Screws)**

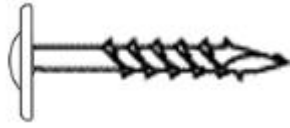

Use to hang cabinets, large head, coarse threads, #17 point

Item Nbr	Description	Package Type	Weight	ACQ / CA	Count Per Lb	Brand
0317156	2 1/2" x 10 Cabinet Mounting Combo Drive Screw	10 - 1 lbs Box(s)	10	No	80	ProFit
0317152	2 1/2" x 10 Cabinet Mounting Combo Drive Screw	1 - 2 M Box(s)	25	No	80	ProFit
0317157	2 1/2" x 10 Cabinet Mounting Combo Drive Screw	25 - 1 lbs Box(s)	25	No	80	ProFit
0317197	3 1/2" x 10 Cabinet Combo Drive Screw	25 - 1 lbs Box(s)	25	No	58	ProFit
0317196	3 1/2" x 10 Cabinet Combo Drive Screw	10 - 1 lbs Box(s)	10	No	58	ProFit
0317192	3 1/2" x 10 Cabinet Mounting Combo Drive Screw	1 - 1 M Box(s)	17	No	58	ProFit

PROFIT
PROFESSIONAL FIT **Cement Board Screw (Phillips) (Interior Screws)**



Use for attaching cement board to wood studs

Item Nbr	Description	Package Type	Weight	ACQ / CA	Count Per Lb	Brand
0313077	1 1/4" x 8 Cement Board Phillips Head Screw	25 - 1 lbs Box(s)	25	No	217	ProFit
0313076	1 1/4" x 8 Cement Board Phillips Head Screw	10 - 1 lbs Box(s)	10	No	217	ProFit
0312072	1 5/8" x 8 Cement Board Phillips Head Screw	1 - 5 M Box(s)	23	No	217	ProFit
0312102	1 5/8" x 8 Cement Board Phillips Head Screw	1 - 4 M Box(s)	26.5	No	166	ProFit
0313106	1 5/8" x 8 Cement Board Phillips Head Screw	10 - 1 lbs Box(s)	10	No	166	ProFit
0313107	1 5/8" x 8 Cement Board Phillips Head Screw	25 - 1 lbs Box(s)	25	No	166	ProFit

PROFIT
PROFESSIONAL FIT **Concrete Screw Blue (Hex) (Interior Screws)**



Hex Head fastening to concrete in predrilled holes

Item Nbr	Description	Package Type	Weight	ACQ / CA	Count Per Lb	Brand
0319070	1/4" x 1 1/4" Blue Con-Sert Hex Head Screw	1 - 100 ct Box(s)	1.41	No	82	ProFit
0318070	3/16" x 1 1/4" Blue Con-Sert Hex Head Screw	1 - 100 ct Box(s)	0.88	No	140	ProFit
0319110	1/4" x 1 3/4" Blue Con-Sert Hex Head Screw	1 - 100 ct Box(s)	1.75	No	62	ProFit
0318110	3/16" x 1 3/4" Blue Con-Sert Hex Head Screw	1 - 100 ct Box(s)	1.14	No	139	ProFit
0319140	1/4" x 2 1/4" Blue Con-Sert Hex Head Screw	1 - 100 ct Box(s)	2.17	No	48	ProFit
0318140	3/16" x 2 1/4" Blue Con-Sert Hex Head Screw	1 - 100 ct Box(s)	1.34	No	83	ProFit
0319160	1/4" x 2 3/4" Blue Con-Sert Hex Head Screw	1 - 100 ct Box(s)	2.6	No	42	ProFit
0318160	3/16" x 2 3/4" Blue Con-Sert Hex Head Screw	1 - 100 ct Box(s)	1.58	No	70	ProFit
0319180	1/4" x 3 1/4" Blue Con-Sert Hex Head Screw	1 - 100 ct Box(s)	3.04	No	36	ProFit
0318180	3/16" x 3 1/4" Blue Con-Sert Hex Head Screw	1 - 100 ct Box(s)	1.83	No	60	ProFit
0319200	1/4" x 4" Blue Con-Sert Hex Head Screw	1 - 100 ct Box(s)	3.67	No	30	ProFit
0318200	3/16" x 4" Blue Con-Sert Hex Head Screw	1 - 100 ct Box(s)	2.2	No	50	ProFit

PROFIT
PROFESSIONAL FIT **Concrete Screw Blue (Phillips) (Interior Screws)**

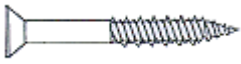

Phillips head fastening to concrete in predrilled hole

Item Nbr	Description	Package Type	Weight	ACQ / CA	Count Per Lb	Brand
0321070	1/4 x 1 1/4" Blue Con-Sert Phillips Head Screw	1 - 100 ct Box(s)	1.23	No	82	ProFit
0320070	3/16 x 1 1/4" Blue Con-Sert Phillips Head Screw	1 - 100 ct Box(s)	0.82	No	140	ProFit
0321110	1/4 x 1 3/4" Blue Con-Sert Phillips Head Screw	1 - 100 ct Box(s)	1.65	No	62	ProFit
0320110	3/16 x 1 3/4" Blue Con-Sert Phillips Head Screw	1 - 100 ct Box(s)	1.04	No	139	ProFit
0321140	1/4 X 2 1/4" Blue Con-Sert Phillips Head Screw	1 - 100 ct Box(s)	2	No	48	ProFit
0320140	3/16 x 2 1/4" Blue Con-Sert Phillips Head Screw	1 - 100 ct Box(s)	1.26	No	83	ProFit
0321160	1/4 x 2 3/4" Blue Con-Sert Phillips Head Screw	1 - 100 ct Box(s)	2.38	No	42	ProFit
0320160	3/16 x 2 3/4" Blue Con-Sert Phillips Head Screw	1 - 100 ct Box(s)	1.53	No	70	ProFit
0321180	1/4 x 3 1/4" Blue Con-Sert Phillips Head Screw	1 - 100 ct Box(s)	2.84	No	36	ProFit
0320180	3/16 x 3 1/4" Blue Con-Sert Phillips Head Screw	1 - 100 ct Box(s)	1.77	No	60	ProFit
0321190	1/4 x 3 3/4" Blue Con-Sert Phillips Head Screw	1 - 100 ct Box(s)	3.28	No	31	ProFit
0320190	3/16 x 3 3/4" Blue Con-Sert Phillips Head Screw	1 - 100 ct Box(s)	2.04	No	54	ProFit
0321200	1/4 x 4" Blue Con-Sert Phillips Head Screw	1 - 100 ct Box(s)	3.5	No	30	ProFit
0320200	3/16 x 4" Blue Con-Sert Phillips Head Screw	1 - 100 ct Box(s)	2.75	No	50	ProFit

PROFIT
PROFESSIONAL FIT **Drywall - All Purpose Coarse (Interior Screws)**

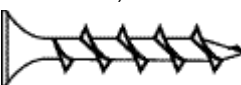

Use for drywall to wood studs and all purpose wood fastening, Phillips drive, bugle head, coarse thread, sharp point

Item Nbr	Description	Package Type	Weight	ACQ / CA	Count Per Lb	Brand
0287052	1" x 6 Drywall Coarse Thread Screw	1 - 10 M Box(s)	31.75	No	333	ProFit
0286050	1" x 6 Drywall Coarse Thread Screw	10 - 100 ct Box(s)	2	No	333	ProFit
0286055	1" x 6 Drywall Coarse Thread Screw	6 - 5 lbs Box(s)	30	No	333	ProFit
0286056	1" x 6 Drywall Coarse Thread Screw	10 - 1 lbs Box(s)	10	No	333	ProFit
0286057	1" x 6 Drywall Coarse Thread Screw	25 - 1 lbs Box(s)	25	No	333	ProFit
0286059	1" x 7 Drywall Coarse Thread Screw	1 - 25 lbs Pail(s)	25	No	333	ProFit
0287071	1 1/4" x 6 Drywall Coarse Thread Screw		1	No	285	ProFit
0286079	1 1/4" x 6 Drywall Coarse Thread Screw	1 - 25 lbs Pail(s)	25	No	285	ProFit
0286076	1 1/4" x 6 Drywall Coarse Thread Screw	10 - 1 lbs Box(s)	10	No	285	ProFit
0286077	1 1/4" x 6 Drywall Coarse Thread Screw	25 - 1 lbs Box(s)	25	No	285	ProFit
0286070	1 1/4" x 6 Drywall Coarse Thread Screw	10 - 90 ct Box(s)	2	No	285	ProFit
0287072	1 1/4" x 6 Drywall Coarse Thread Screw	1 - 8 M Box(s)	29.98	No	285	ProFit
0286075	1 1/4" x 6 Drywall Coarse Thread Screw	6 - 5 lbs Box(s)	30	No	285	ProFit
0287102	1 5/8" x 6 Drywall Coarse Thread Screw	1 - 5 M Box(s)	23.59	No	217	ProFit
0286105	1 5/8" x 6 Drywall Coarse Thread Screw	6 - 5 lbs Box(s)	30	No	217	ProFit
0286109	1 5/8" x 6 Drywall Coarse Thread Screw	1 - 25 lbs Pail(s)	25	No	217	ProFit
0286106	1 5/8" x 6 Drywall Coarse Thread Screw	10 - 1 lbs Box(s)	10	No	217	ProFit
0286107	1 5/8" x 6 Drywall Coarse Thread Screw	25 - 1 lbs Box(s)	25	No	217	ProFit
0286100	1 5/8" x 6 Drywall Coarse Thread Screw	10 - 65 ct Box(s)	3	No	217	ProFit
0286130	2" x 6 Drywall Coarse Thread Screw	10 - 50 ct Box(s)	3	No	175	ProFit
0286136	2" x 6 Drywall Coarse Thread Screw	10 - 1 lbs Box(s)	10	No	175	ProFit
0286135	2" x 6 Drywall Coarse Thread Screw	6 - 5 lbs Box(s)	30	No	175	ProFit
0286137	2" x 6 Drywall Coarse Thread Screw	25 - 1 lbs Box(s)	25	No	175	ProFit
0287132	2" x 6 Drywall Coarse Thread Screw	1 - 3.5 M Box(s)	19.68	No	175	ProFit
0286139	2" x 6 Drywall Coarse Thread Screw	1 - 25 lbs Pail(s)	25	No	175	ProFit

0286159	2 1/2" x 7 Drywall Coarse Thread Screw	1 - 25 lbs Pail(s)	25	No	119	ProFit
0287152	2 1/2" x 7 Drywall Coarse Thread Screw	1 - 2.5 M Box(s)	20.67	No	119	ProFit
0286156	2 1/2" x 7 Drywall Coarse Thread Screw	10 - 1 lbs Box(s)	10	No	119	ProFit
0286150	2 1/2" x 7 Drywall Coarse Thread Screw	10 - 30 ct Box(s)	2	No	119	ProFit
0286155	2 1/2" x 7 Drywall Coarse Thread Screw	6 - 5 lbs Box(s)	30	No	119	ProFit
0286157	2 1/2" x 7 Drywall Coarse Thread Screw	25 - 1 lbs Box(s)	25	No	119	ProFit
0286179	3" x 7 Drywall Coarse Thread Screw	1 - 25 lbs Pail(s)	25	No	90	ProFit
0287172	3" x 8 Drywall Coarse Thread Screw	1 - 2 M Box(s)	21.61	No	90	ProFit
0286176	3" x 8 Drywall Coarse Thread Screw	10 - 1 lbs Box(s)	10	No	90	ProFit
0286170	3" x 8 Drywall Coarse Thread Screw	10 - 25 ct Box(s)	2	No	90	ProFit
0286177	3" x 8 Drywall Coarse Thread Screw	25 - 1 lbs Box(s)	25	No	90	ProFit
0286175	3" x 8 Drywall Coarse Thread Screw	6 - 5 lbs Box(s)	30	No	90	ProFit
0286197	3 1/2" x 10 Coarse Thread Drywall Screw	25 - 1 lbs Box(s)	25	No	55	ProFit
0286196	3 1/2" x 10 Coarse Thread Drywall Screw	10 - 1 lbs Box(s)	10	No	55	ProFit
0286195	3 1/2" x 10 Drywall Coarse Thread Screw	6 - 5 lbs Box(s)	30	No	55	ProFit
0287192	3 1/2" x 10 Drywall Coarse Thread Screw	1 - 1 M Box(s)	17.66	No	55	ProFit
0286199	3 1/2" x 10 Drywall Coarse Thread Screw	1 - 25 lbs Pail(s)	25	No	55	ProFit
0286209	4" x 10 Coarse Thread Screw	1 - 25 lbs Pail(s)	25	No	50	ProFit
0286205	4" x 10 Coarse Thread Screw	6 - 5 lbs Box(s)	30	No	50	ProFit
0286207	4" x 10 Drywall Coarse Thread Screw	25 - 1 lbs Box(s)	25	No	50	ProFit
0286206	4" x 10 Drywall Coarse Thread Screw	10 - 1 lbs Box(s)	10	No	50	ProFit
0286200	4" x 10 Drywall Coarse Thread Screw	10 - 20 ct Box(s)	5	No	50	ProFit
0287202	4" x 10 Drywall Coarse Thread Screw	1 - 1 M Box(s)	20.13	No	50	ProFit
0286220	5" x 10 Drywall Coarse Thread Screw	10 - 10 ct Box(s)	3	No	45	ProFit
0287222	5" x 10 Drywall Coarse Thread Screw	1 - 1 M Box(s)	25.13	No	45	ProFit
0287242	6" x 10 Drywall Coarse Thread Screw	1 - 1 M Box(s)	29.54	No	41	ProFit
0286240	6" x 10 Drywall Coarse Thread Screw	10 - 10 ct Box(s)	3	No	41	ProFit

PROFIT
PROFESSIONAL FIT Drywall - All Purpose Fine (Interior Screws)

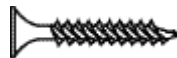

Use for drywall to light gauge steel studs, Philips drive, bugle head, fine thread, sharp point

Item Nbr	Description	Package Type	Weight	ACQ / CA	Count Per Lb	Brand
0280057	1" x 6 Drywall Fine Thread Screw	25 - 1 lbs Box(s)	25	No	333	ProFit
0280056	1" x 6 Drywall Fine Thread Screw	10 - 1 lbs Box(s)	10	No	333	ProFit
0280055	1" x 6 Drywall Fine Thread Screw	6 - 5 lbs Box(s)	30	No	333	ProFit
0280050	1" x 6 Drywall Fine Thread Screw - Display	10 - 100 ct Box(s)	2	No	333	ProFit
0283052	1" x 6 Drywall Fine Thread Screw - Import	1 - 10 M Box(s)	31.53	No	333	ProFit
0280076	1 1/4" x 6 Drywall Fine Thread Screw	10 - 1 lbs Box(s)	10	No	285	ProFit
0280075	1 1/4" x 6 Drywall Fine Thread Screw	6 - 5 lbs Box(s)	30	No	285	ProFit
0280079	1 1/4" x 6 Drywall Fine Thread Screw	1 - 25 lbs Pail(s)	25	No	285	ProFit
0280077	1 1/4" x 6 Drywall Fine Thread Screw	25 - 1 lbs Box(s)	25	No	285	ProFit
0280070	1 1/4" x 6 Drywall Fine Thread Screw - Display	10 - 90 ct Box(s)	2	No	285	ProFit
0283072	1 1/4" x 6 Drywall Fine Thread Screw - Import	1 - 8 M Box(s)	29.98	No	285	ProFit
0280106	1 5/8" x 6 Drywall Fine Thread Screw	10 - 1 lbs Box(s)	10	No	217	ProFit
0280105	1 5/8" x 6 Drywall Fine Thread Screw	6 - 5 lbs Box(s)	30	No	217	ProFit
0280107	1 5/8" x 6 Drywall Fine Thread Screw	25 - 1 lbs Box(s)	25	No	217	ProFit
0280109	1 5/8" x 6 Drywall Fine Thread Screw	1 - 25 lbs Pail(s)	25	No	217	ProFit
0283102	1 5/8" x 6 Drywall Fine Thread Screw - Import	1 - 5 M Box(s)	23.7	No	217	ProFit
0280100	1 5/8" x 6 Drywall Fine Thread Screw- Display	10 - 65 ct Box(s)	3	No	217	ProFit
0280135	2" x 6 Drywall Fine Thread Screw	6 - 5 lbs Box(s)	30	No	175	ProFit
0280137	2" x 6 Drywall Fine Thread Screw	25 - 1 lbs Box(s)	25	No	175	ProFit
0280136	2" x 6 Drywall Fine Thread Screw	10 - 1 lbs Box(s)	10	No	175	ProFit
0280139	2" x 6 Drywall Fine Thread Screw	1 - 25 lbs Pail(s)	25	No	175	ProFit

0280130	2" x 6 Drywall Fine Thread Screw - Display	10 - 50 ct Box(s)	3	No	175	ProFit
0283132	2" x 6 Drywall Fine Thread Screw - Import	1 - 3.5 M Box(s)	19.91	No	175	ProFit
0280156	2 1/2" x 7 Drywall Fine Thread Screw	10 - 1 lbs Box(s)	10	No	119	ProFit
0280155	2 1/2" x 7 Drywall Fine Thread Screw	6 - 5 lbs Box(s)	30	No	119	ProFit
0280157	2 1/2" x 7 Drywall Fine Thread Screw	25 - 1 lbs Box(s)	25	No	119	ProFit
0283152	2 1/2" x 7 Drywall Fine Thread Screw - Import	1 - 2.5 M Box(s)	20.28	No	119	ProFit
0280150	2 1/2" x 8 Drywall Fine Thread Screw - Display	10 - 30 ct Box(s)	2	No	119	ProFit
0280176	3" x 8 Drywall Fine Thread Screw	10 - 1 lbs Box(s)	10	No	90	ProFit
0280175	3" x 8 Drywall Fine Thread Screw	6 - 5 lbs Box(s)	30	No	90	ProFit
0280177	3" x 8 Drywall Fine Thread Screw	25 - 1 lbs Box(s)	25	No	90	ProFit
0280170	3" x 8 Drywall Fine Thread Screw - Display	10 - 25 ct Box(s)	2	No	90	ProFit
0283172	3" x 8 Drywall Fine Thread Screw - Import	1 - 2 M Box(s)	21.91	No	90	ProFit
0280195	3 1/2" x 10 Drywall Fine Thread Screw	6 - 5 lbs Box(s)	30	No	55	ProFit
0283192	3 1/2" x 10 Drywall Fine Thread Screw - Import	1 - 1 M Box(s)	17.46	No	55	ProFit
0280197	3 1/2" x 10 Drywall Screw	25 - 1 lbs Box(s)	25	No	55	ProFit
0283202	4" x 10 Drywall Fine Thread Screw - Import	1 - 1 M Box(s)	19.58	No	50	ProFit
0280207	4" x 10 Drywall Screw	25 - 1 lbs Box(s)	25	No	50	ProFit

PROFIT PROFESSIONAL FIT **Drywall -Self Drill Bugle (Phillips) (Interior Screws)**



Use for drywall to 20 gauge to 14 gauge steel studs. Philips drive, bugle head, fine thread, self drilling point

Item Nbr	Description	Package Type	Weight	ACQ / CA	Count Per Lb	Brand
0288074	1 1/4" x 6 Self Drill Bugle Head Screw	4 - 500 ct Box(s)	8	No	250	ProFit
0288079	1 1/4" x 6 Self Drill Bugle Head Screw - Zinc	1 - 25 lbs Pail(s)	25	No	250	ProFit
0288077	1 1/4" x 6 Self Drill Phillips Bugle Head Screw	25 - 1 lbs Box(s)	25	No	250	ProFit
0288076	1 1/4" x 6 Self Drill Phillips Bugle Head Screw	10 - 1 lbs Box(s)	10	No	250	ProFit
0288075	1 1/4" x 6 Self Drill Phillips Drive Screw - Zinc	6 - 5 lbs Box(s)	30	No	250	ProFit
0288072	1 1/4" x 6 Self Drill Screw - Zinc	1 - 8 M Box(s)	32	No	250	ProFit
0288104	1 5/8" x 6 Self Drill Bugle Head Screw	4 - 500 ct Box(s)	10	No	192	ProFit
0288109	1 5/8" x 6 Self Drill Bugle Head Screw - Zinc	1 - 25 lbs Pail(s)	25	No	192	ProFit
0288105	1 5/8" x 6 Self Drill Bugle Head Screw - Zinc	6 - 5 lbs Box(s)	30	No	192	ProFit
0288107	1 5/8" x 6 Self Drill Phillips Bugle Head Screw	25 - 1 lbs Box(s)	25	No	192	ProFit
0288106	1 5/8" x 6 Self Drill Phillips Bugle Head Screw	10 - 1 lbs Box(s)	10	No	192	ProFit
0288102	1 5/8" x 6 Self Drill Screw - Zinc	1 - 5 M Box(s)	26	No	192	ProFit
0288127	1 7/8" Self Drill Bugle Head Screw	25 - 1 lbs Box(s)	25	No	174	ProFit
0288129	1 7/8" Self Drill Bugle Head Screw - Zinc	1 - 25 lbs Pail(s)	25	No	174	ProFit
0288122	1 7/8" Self Drill Bugle Head Screw - Zinc	1 - 4 M Box(s)	25	No	174	ProFit
0288125	1 7/8" x 6 Self Drill Bugle Head Screw - Zinc	6 - 5 lbs Box(s)	30	No	174	ProFit
0288147	2 3/8" x 8 Self Drill Phillips Bugle Head Screw	25 - 1 lbs Box(s)	25	No	104	ProFit
0288146	2 3/8" x 8 Self Drill Phillips Bugle Head Screw	10 - 1 lbs Box(s)	10	No	104	ProFit
0288142	2 3/8" x 8 Self Drill Phillips Head Screw	1 - 2.5 M Box(s)	25	No	104	ProFit
0288162	2 5/8" x 8 Self Drill Phillips Head Screw	1 - 2 M Box(s)	25	No	91	ProFit
0288172	3" x 8 Self Drill Phillips Head - Zinc	1 - 2 M Box(s)	25	No	83	ProFit

PROFIT
PROFESSIONAL FIT **K-Lath Screw Self Drill (Phillips)** (Interior Screws)

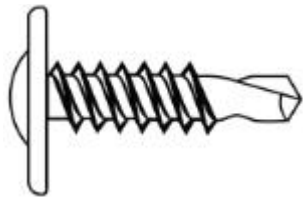

Use for metal to metal 20 to 14 gauge where a low profile head is required

Item Nbr	Description	Package Type	Weight	ACQ / CA	Count Per Lb	Brand
0309016	1/2" x 8 K-Lath Self Drill Screw	10 - 1 lbs Box(s)	10	No	277	ProFit
0309012	1/2" x 8 K-Lath Self Drill Screw - Zinc	1 - 10 M Box(s)	36.4	No	277	ProFit
0309014	1/2" x 8 K-Lath Self Drill Screw - Zinc	6 - 5 lbs Box(s)	30	No	277	ProFit
0309017	1/2" x 8 K-Lath Self Drill Screw - Zinc	25 - 1 lbs Box(s)	25	No	277	ProFit
0309019	1/2" x 8 K-Lath Self Drill Screw - Zinc	1 - 25 lbs Pail(s)	25	No	277	ProFit
0309034	3/4" x 8 K-Lath Self Drill Screw - Zinc	6 - 5 lbs Box(s)	30	No	216	ProFit
0309032	3/4" x 8 K-Lath Self Drill Screw - Zinc	1 - 10 M Box(s)	38	No	216	ProFit
0309037	3/4" x 8 K-Lath Self Drill Screw - Zinc	25 - 1 lbs Box(s)	25	No	216	ProFit
0309076	1 1/4" x 8 K-Lath Self Drill Screw	1 - 10 lbs Box(s)	10	No	146	ProFit
0309074	1 1/4" x 8 K-Lath Self Drill Screw - Zinc	6 - 5 lbs Box(s)	30	No	146	ProFit
0309072	1 1/4" x 8 K-Lath Self Drill Screw - Zinc	1 - 6 M Box(s)	40.8	No	146	ProFit
0309077	1 1/4" x 8 K-Lath Self Drill Screw - Zinc	25 - 1 lbs Box(s)	25	No	146	ProFit
0309102	1 5/8" x 8 K-Lath Self Drill Screw - Zinc	1 - 4 M Box(s)	24.8	No	125	ProFit
0309104	1 5/8" x 8 K-Lath Self Drill Screw - Zinc	6 - 5 lbs Box(s)	30	No	125	ProFit
0309107	1 5/8" x 8 K-Lath Self Drill Screw - Zinc	25 - 1 lbs Box(s)	25	No	125	ProFit

PROFIT
PROFESSIONAL FIT **Pan Head Self Drilling** (Interior Screws)



Phillips #2 drive, metal to metal fastening 16 to 20 ga

Item Nbr	Description	Package Type	Weight	ACQ / CA	Count Per Lb	Brand
0303016	7/16" x 6 Pan Head Self Drill Screw	10 - 1 lbs Box(s)	10	No	400	ProFit
0303014	7/16" x 6 Pan Head Self Drill Screw	6 - 5 lbs Box(s)	30	No	400	ProFit
0303017	7/16" x 6 Pan Head Self Drill Screw	25 - 1 lbs Box(s)	25	No	400	ProFit

PROFIT
PROFESSIONAL FIT **Pan Head Self Piercing** (Interior Screws)

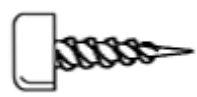

Phillips #2 drive, metal to metal fastening 20 to 25 ga

Item Nbr	Description	Package Type	Weight	ACQ / CA	Count Per Lb	Brand
0290014	7/16" x 6 Pan Head Self Pierce Screw	6 - 5 lbs Box(s)	30	No	400	ProFit
0290016	7/16" x 6 Pan Head Self Pierce Screw	10 - 500 ct Box(s)	14	No	400	ProFit
0290017	7/16" x 6 Pan Head Self Pierce Screw	25 - 1 lbs Box(s)	25	No	400	ProFit
0290012	7/16" x 6 Pan Head Self Pierce Screw	1 - 10 M Box(s)	25	No	400	ProFit

PROFIT
PROFESSIONAL FIT **Trim Head Screw Square Drive (Interior Screws)**

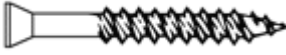

Use for molding and trim fastened to light gauge metal studs

Item Nbr	Description	Package Type	Weight	ACQ / CA	Count Per Lb	Brand
0289102	1 5/8" x 6 Trim Head Square Drive Screw	1 - 5 M Box(s)	24	No	208	ProFit
0289107	1 5/8" x 6 Trim Head Square Drive Screw	25 - 1 lbs Box(s)	25	No	208	ProFit
0289105	1 5/8" x 6 Trim Head Square Drive Screw	6 - 5 lbs Box(s)	30	No	208	ProFit
0289106	1 5/8" x 6 Trim Head Square Drive Screw	10 - 150 ct Box(s)	7	No	208	ProFit
0289142	2 1/4" x 6 Trim Head Square Drive Screw	1 - 3 M Box(s)	18	No	166	ProFit
0289146	2 1/4" x 6 Trim Head Square Drive Screw	10 - 150 ct Box(s)	10	No	166	ProFit
0289147	2 1/4" x 6 Trim Head Square Drive Screw	25 - 1 lbs Box(s)	25	No	166	ProFit
0289145	2 1/4" x 6 Trim Head Square Drive Screw	6 - 5 lbs Box(s)	30	No	166	ProFit
0289172	3" x 10 Trim Head Square Drive Screw	1 - 2 M Box(s)	20	No	70	ProFit

PROFIT
PROFESSIONAL FIT **Wafer Head Screw Self Drill (Zinc) (Interior Screws)**



Used to fasten plywood to metal studs

Item Nbr	Description	Package Type	Weight	ACQ / CA	Count Per Lb	Brand
0315082	1 7/16" x 10 Wafer Head Self Drill Screw - Zinc	1 - 3.5 M Box(s)	32	No	109	ProFit
0315087	1 7/16" x 10 Wafer Head Self Drill Screw - Zinc	25 - 1 lbs Box(s)	25	No	109	ProFit
0315086	1 7/16" x 10 Wafer Head Self Drill Screw - Zinc	10 - 1 lbs Box(s)	10	No	109	ProFit

Product list subject to availability. Some products are only available regionally. [Contact Us](#) to verify availability in your area.

Screw Accessories

PROFIT
PROFESSIONAL FIT **Screwdriver Bits (Screw Accessories)**



insert and power bits for the post popular drive types

Item Nbr	Description	Package Type	Weight	ACQ / CA	Count Per Lb	Brand
0970024	250-SP-2 Combo Square-Phillips Insert Bit	1 - 25 pcs Bag(s)	0	No	0	ProFit
0970025	30-2SP Combo Square-Phillips Power Bit	1 - 15 pcs Bag(s)	0	No	0	ProFit
0970005	250PB1 #1 Phillips Insert Bit 1"	1 - 50 pcs Bag(s)	0	No	0	ProFit
0970006	250PB2 #2 Phillips Insert Bit 1"	1 - 100 pcs Bag(s)	0	No	0	ProFit
0970007	250PB3 #3 Phillips Insert Bit 1"	1 - 50 pcs Bag(s)	0	No	0	ProFit
0970008	250PBR2 #2 Reduced Phillips Insert Bit 1"	1 - 75 pcs Bag(s)	0	No	0	ProFit
0970000	30-1P #1 Phillips Power Bit 2"	1 - 50 pcs Bag(s)	0.5	No	0	ProFit
0970001	30-2P #2 Phillips Power Bit 2"	1 - 50 pcs Bag(s)	0	No	0	ProFit
0970002	30-3P #3 Phillips Power Bit 2"	1 - 50 pcs Bag(s)	0	No	0	ProFit
0970003	32-2P #2 Phillips Power Bit 2 3/4"	1 - 25 pcs Bag(s)	0	No	0	ProFit

0970004	34-2P #2 Phillips Power Bit 3 1/2"	1 - 30 pcs Bag(s)	0	No	0	ProFit
0970009	250SS4 4F-5R Slot Insert Bit 1"	1 - 25 pcs Bag(s)	0	No	0	ProFit
0970010	250SS6 6F-7R Slot Insert Bit 1"	1 - 25 pcs Bag(s)	0	No	0	ProFit
0970011	250SS8 8F-10R Slot Insert Bit 1"	1 - 25 pcs Bag(s)	0	No	0	ProFit
0970026	250R2 #2 Square Insert Bit		1	No	0	ProFit
0970022	80-1R #1 Square Drive Power Bit 2"		1	No	0	ProFit
0970019	80-2R #2 Square Drive Power Bit 2"	1 - 25 pcs Bag(s)	0	No	0	ProFit
0970020	80-3R #3 Square Drive Power Bit 2"	1 - 25 pcs Bag(s)	0	No	0	ProFit
0333950	#15 Star Drive Insert Bit	10 - 6 ct Box(s)	0.62	No	0	ProFit
0333900	#15 Star Drive Power Bit	10 - 3 ct Box(s)	0.74	No	0	ProFit
0333960	#20 Star Drive Insert Bit	10 - 6 ct Box(s)	0.62	No	0	ProFit
0333910	#20 Star Drive Power Bit	10 - 3 ct Box(s)	0.74	No	0	ProFit
0333970	#25 Star Drive Insert Bit	10 - 6 ct Box(s)	0.62	No	0	ProFit
0333920	#25 Star Drive Power Bit	10 - 3 ct Box(s)	0.74	No	0	ProFit
0333980	#40 Star Drive Insert Bit	10 - 6 ct Box(s)	0.62	No	0	ProFit
0333930	#40 Star Drive Power Bit	10 - 3 ct Box(s)	0.74	No	0	ProFit

Product list subject to availability. Some products are only available regionally. [Contact Us](#) to verify availability in your area.