

STABILA®



How true pro's measure

U.S.A./CANADA



PRODUCTS CATALOG

STABILA Defined.

We are a German manufacturer of specialty measuring and layout tools.

Our products are the preferred choice of professionals around the world. STABILA precision measuring tools perform faster and easier allowing you to be more profitable.

The STABILA line of products are factory tested and are job site durable. Our tools are able to handle real construction site conditions all the while providing tradespeople the dependability and consistent accuracy they expect and deserve.

STABILA Accuracy.

All accuracy tolerances stated by STABILA are absolute values. STABILA products will never perform below their stated accuracy.



STABILA Warranty.

SPIRIT LEVELS

STABILA levels remain accurate indefinitely. Vials on all STABILA levels will not fog, leak, or become inaccurate. Levels with inaccurate vials are replaced. (Damaged frames void warranty.)

LASERS and TECH LEVELS

We repair, without charge, any defects due to faulty materials or workmanship for 2 years from date of purchase. 48 hours service turnaround time.

ACCESSORIES

Tape Measures, Tripods, Cases, Grade Rods, Etc. 30 day warranty against manufacturer defects from the date of purchase.

STABILA requires original proof of purchase receipt from a U.S.A./Canada dealer for warranty coverage to be effective.









Table of Contents:

Spirit Levels	4
Tech Levels	12
Special Levels	14
Laser Levels	24
Laser Distance Measuring ...	38
Receivers, Tripods, Tapes and Rules	42



Spirit levels

	Type R. 300	Type 196	Type 96 M	Type 196 LED	Type 196-2 K	Type 106 T / 106 TM
						
Profile	Torsion-resistant 5-chamber 'R.' profile	Ultra-rigid aluminum rectangular profile reinforcing ribs	Ultra-rigid aluminum rectangular profile reinforcing ribs	Ultra-rigid aluminum rectangular profile reinforcing ribs	Ultra-rigid aluminum rectangular profile reinforcing ribs	3-chamber aluminum rectangular profile reinforcing ribs
Accuracy - top read	± 1/32" @ 72"	± 1/32" @ 72"	± 1/32" @ 72"	± 1/32" @ 72"	± 1/32" @ 72"	± 1/32" @ 72"
Accuracy - bottom read	± 1/32" @ 72"	± 1/32" @ 72"	± 1/32" @ 72"	± 1/32" @ 72"	± 3/64" @ 72"	± 3/64" @ 72"
End caps	Anti-slip stopper/ Shock-absorbing/ Removable	Anti-slip stopper/ Shock-absorbing/ Removable	Anti-slip stopper/ Shock-absorbing/ Removable	Anti-slip stopper/ Shock-absorbing/ Removable	Anti-slip stopper/ Shock-absorbing/ Removable	Standard
Lengths	48", 72", 96"	16" through 96"	16" through 96"	24", 48"	16", 24", 36", 48"	6' » 10', 7' » 12'
Additional features						
Magnetic system	-	-	Recessed magnets	-	-	Type 106TM Recessed magnets
Lighting	-	-	-	2 LED Lights	-	-
Protection	-	-	-	-	Dead Blow Shields	-







STABILA levels are manufactured with German precision.

The quality built into our levels proves they will withstand the job site.

Tools need to perform on the construction site. You need to rely on your tools day in and day out. Just imagine this scenario one day on the job site: your spirit level accidentally falls from the scaffolding and takes a hard bounce. But when you retrieve it you notice its okay and just as accurate as it was the first day it was purchased. That is the STABILA quality!

STABILA spirit levels are constructed with a fixed molded vial which measures absolutely accurately even under demanding conditions – no readjustment necessary. For this reason craftsmen worldwide trust our spirit levels.

At STABILA, we offer craftsman a variety of levels specific to their trade: depending on their requirements and trade needs we have manufactured levels ranging from - lightweight or rugged, short or long, and levels which were designed for a particular trade.

Spirit levels						
	Type 80 T	Type 80 A / 80 AM	Type 70 A	Measuring Stick	Torpedoes	Pocket Levels
						
Profile	Smooth aluminum rectangular profile	Aluminum profile with reinforcing ribs	Smooth aluminum rectangular profile	Smooth aluminum rectangular profile	Die-cast aluminum	Plastic profile with aluminum housing
Accuracy - top read	± 1/32" @ 72"	± 1/32" @ 72"	± 1/32" @ 72"	± 1/32" @ 72"	± 1/32" @ 72"	± 1/16" @ 60"
Accuracy - bottom read	± 3/64" @ 72"	± 3/64" @ 72"	± 3/64" @ 72"	± 3/64" @ 72"	± 3/64" @ 72"	–
End caps	Anti-slip wall grips	Standard	Standard	Anti-slip wall grips	–	–
Lengths	25" » 41", 36" » 59"	24", 32", 58", 48", 72"	24", 48"	24", 48"	10"	1 5/8" x 2 5/8"
Additional features						
Magnetic system	–	Recessed magnets	–	–	25100, 25245, 25360	Rare-earth magnet
Extension	Telescopic system	–	–	–	–	–
Measure	Printed scale	–	–	Printed scales	–	–

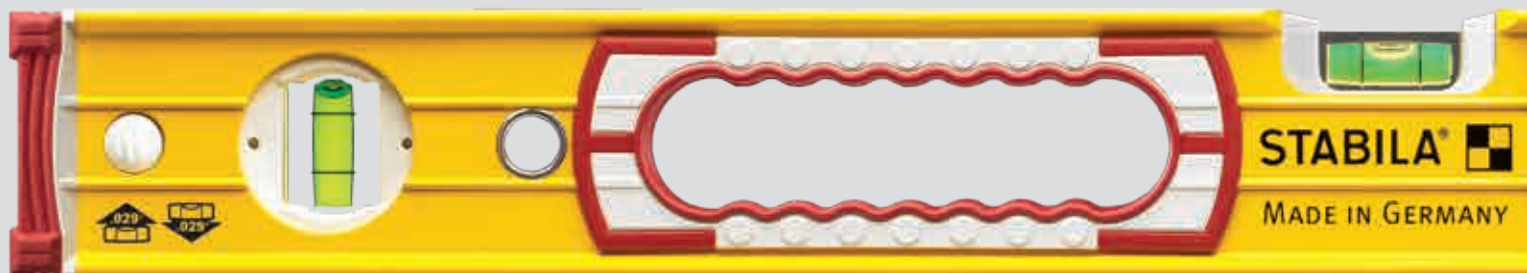

Engineered with micrometer precision

When STABILA spirit levels are manufactured, vials, vial block holders, and measuring surfaces are adjusted precisely to each other before being permanently bonded together with synthetic resin. STABILA's meticulous production processes ensure all components are parallel and unshakably aligned to one another so that spirit levels measure accurately after many years of rugged use.

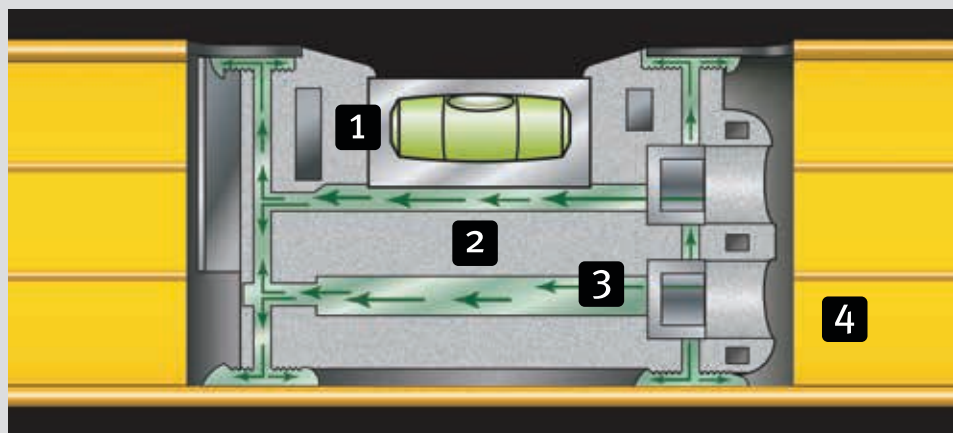

STABILA installation technology

The unique installation technology ensures long-term accuracy. In a special casting process, the components of the spirit level are firmly bonded forever. You can trust that your spirit level will maintain its accuracy for life. It remains accurate, just as it was on the first day. No readjustments, no doubts. Always accurate measurements – even under the most difficult job conditions.

- 1** Vial
- 2** Vial Block Holder
- 3** High Strength Epoxy
- 4** Level Frame

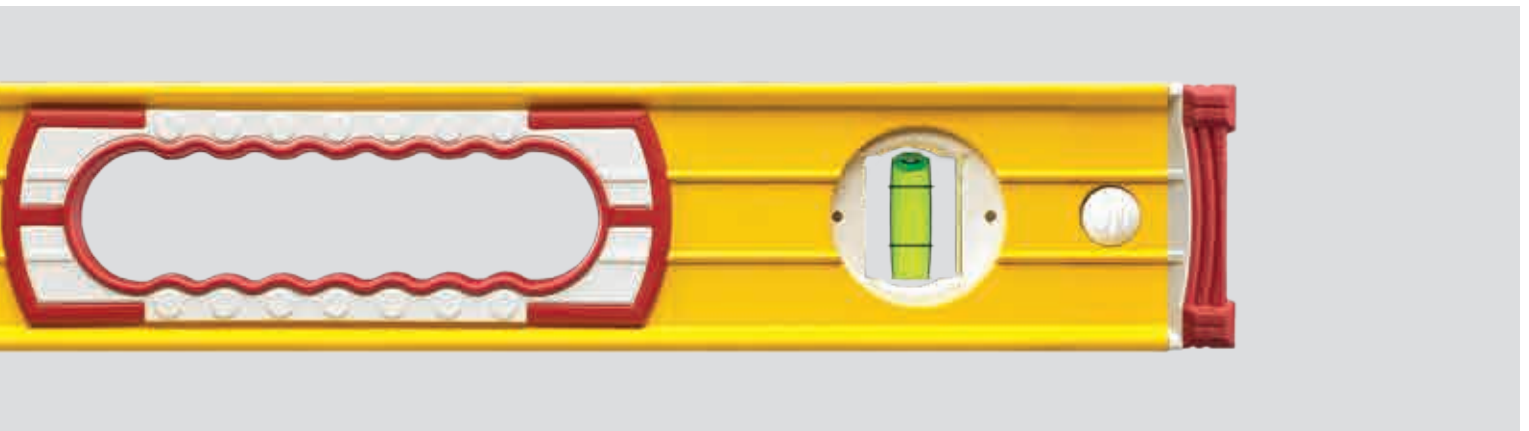

STABILA vials

The vial block is made of high-quality, shatterproof and easy-to-clean acrylic glass. The exterior surfaces must be as flat as possible to prevent light refracting when reading the vial. The interior walls of the vial are precision-ground and the corrosion-free reference rings are flush with the surface - this allows the vial bubble to move freely and unhindered, ensuring maximum measuring precision.



Anti-static factor: STABILA vials prevent the movement of the vial being influenced by static loading or mechanical influences.

UV protection: The fluorescent vial liquid has high resistance against UV rays. This prevents the liquid from fading. The color contrast allows for good readability in all types of light.

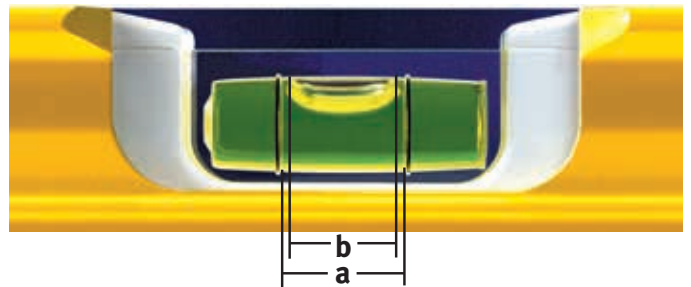

Optimum readability

STABILA spirit levels are extremely temperature-resistant. The bubble size and reference rings are designed to ensure optimum readability, even at high and low temperatures. This guarantees exact readings from -20°C to 50°C . The size of the vial bubble is always within the reference rings; from (a) at -20°C to (b) at 50°C .

Temperature-stable

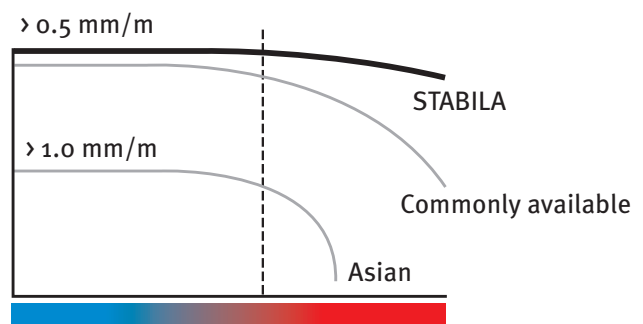

Type R 300

- STABILA's strongest, twist-resistant R-frame built for the most demanding job sites.
- Extra wide measuring surface for increased stability – no tip overs.
- Three straight edges for marking and cutting.
- Continuous grip over the entire length.
- Bridge over the horizontal vial increases the strength of the frame.
- Easy to clean fender smooth finish.
- Shock absorbing endcaps protect frame when dropped.
- STABILA vial installation technology delivers long-term accuracy.





Type R 300 - Specifications

Type
Accuracy - top read
Accuracy - bottom read
Vial type
End caps
Special feature
Length
48"
72"
96"



R 300
1/32" @ 72"
1/32" @ 72"
1 x horizontal 2 x vertical
Anti-slip end caps / Shock absorbing / Removable
Strong R-Beam frame
Part No.
41048
41072
41096

Application / Additional features



Extremely durable:
Twist resistant five-chamber "R" frame. Developed for the most demanding jobs.



Extremely stable:
Extra wide measuring surface. High level of protection from tipping over.



Precision marking:
3 accurate marking and cutting edges over the full length.



Continuous grip:
Handrail with finger hold over the full length. Continuous bridge over the horizontal vial.



Removable end caps:
Allows exact positioning and transferring lines tight into corners.

Type 196 / 96 M / 196 LED

- Strong aluminum profile with reinforcing ribs – for stability and secure hold.
- End caps with an anti-slip feature – for a firm grip when marking walls.
- Shock absorbing endcaps protect frame when dropped.
- Removable end caps allow exact positioning and marking right up into corners.
- Easy to clean.
- Spirit level with two precision-milled measuring surfaces. (up to 48", coated from 72")
- STABILA vial installation technology ensures long-term accuracy – suitable for measuring in normal and upside down positions.



Type 196 / 96 M / 196 LED - Specifications

Type

Accuracy - top read
Accuracy - bottom read
Vial type
End caps
Special feature

Length

16"
24"
32"
36"
48"
58"
48" & 16" Set
58" * & 32" Set
72" *
78" *
78" & 32" Set
96" *



196
1/32" @ 72"
1/32" @ 72"
1 x horizontal 2 x vertical
Anti-slip / Shock absorbing / Removable
-
Part No.
37416
37424
37432
37436
37448
37459
37816
37832
37472
37478
37532 Jamber® Set
37496

96 M

1/32" @ 72"
1/32" @ 72"
1 x horizontal 2 x vertical
Anti-slip / Shock absorbing / Removable
Rare-earth magnets

Part No.

38616
38624
38632
38636
38648
-
-
-
38672
38678
38532 Mag. Jamber® Set
38696



196 LED

1/32" @ 72"
1/32" @ 72"
1 x horizontal 2 x vertical
Anti-slip / Shock absorbing / Removable
2 LED Lights

Part No.

-
39324
-
-
39340
-
-
-
-
-
-
-
-



* Levels ≥ 58" have a continuous bridge over the horizontal vial.



Application / Additional features



Type 196 and Type 96 M:
For progressive contractors who subject their tools to extremely demanding conditions and need to

measure in all positions – for example: bricklaying, carpentry, concrete, window installation, road construction, and landscaping.

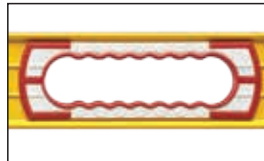

Type 196 and Type 96 M:
Dual material handholes for comfort and grip.



Type 96 M: Rare-earth magnet system - for extra-strong grip to metal objects. The magnets in the 78" level are positioned to grab hinge leaves in pre-hung doors.

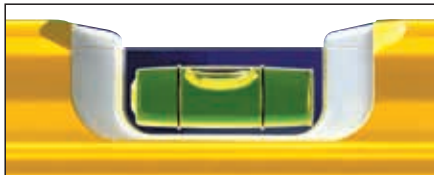

Vials read the same in all positions



Type 196 LED:
For craftsmen who often work in dark or in poor visibility conditions.



Type 196 LED: Removable battery replacement packs.

Type 196 / 196 M TECH

- The gold standard of electronic spirit levels.
- Designed for the most difficult construction site conditions.
- #1 for ADA Ramps.
- Optimal protection – waterproof and dust proof in accordance with class IP 65 certification.
- The spirit level is completely washable.
- Two digital displays which can be read easily regardless of application conditions.
- The acoustic guidance allows materials to be positioned quickly without looking at the level (3 different signals).
- Digital display rotates in reverse position.
- Reference angle mode allows an angle measurement to be accepted, saved and then transferred.
- Feature lock
- Display modes: °, %, mm/m, in/ft – decimal and as fraction; can choose between precision (0.05°) and rough display (0.1°) in degree mode.
- Around 150 hours of operation.
- Includes case

IP 65



Application / Additional features



TECH 196 electronic IP65:
2 displays light up. Dust and waterproof. Easy to re-calibrate. Display reads correctly when positioned upside down.



Type 196 M TECH IP 65:
Especially suitable for metal construction – allows the craftsman to work hands free
Rare-earth magnet system – for extra strong grip to metal objects.



Type 196 / 196 M TECH - Specifications

Type
Accuracy - top read
Accuracy - bottom read
Accuracy with electronic inclination measurement
Vial type
End Caps
Display Modules
Special feature

Length
14"
24"
48"
72"



TECH 196 electronic IP 65
1/32" @ 72"
1/32" @ 72"
at 0° and 90° = ± 0.05° from 1° to 89° = ± 0.20°
1 x horizontal 2 x vertical
Anti-slip stopper / Shock absorbing / Removable
°, %, mm/m, in./ft. – decimal and fraction
–

Part No.
36514 *
36524 **
36548 **
36572 ***

72" TECH level does not come with a case



TECH 196 M electronic IP 65
1/32" @ 72"
1/32" @ 72"
at 0° and 90° = ± 0.05° from 1° to 89° = ± 0.20°
1 x horizontal 2 x vertical
Anti-slip stopper / Shock absorbing / Removable
°, %, mm/m, in./ft. – decimal and fraction
Rare earth magnets

Part No.
–
36520 *
36540 **
–

* Without handholes
** One handhole
*** Two handholes

Type 96-2K / 196-2 K

- Great for bricklayers.
- Strong aluminum frame with patented "Dead Blow Shields" designed to protect frame and transfer energy from trowel impacts to work surfaces.
- Precision-milled measuring surface.
- Easy to clean with water and brush.
- One vertical vial is offset towards the center of the frame, which makes this level easy to read in measuring positions.
- Reinforcing ribs for enhanced strength and secure grip while working.
- Shock absorbing end caps protect frame when dropped.





Application / Additional features



Type 196-2 K:
Especially suitable for masonry and hardscaping

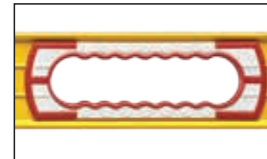

Type 196-2 K:
Dual material handholes for comfort and grip



Type 196-2 K:
Easy water and brush clean up

Type 96-2 K / 196-2 K - Specifications

Type
Accuracy - top read
Accuracy - bottom read
Vial type
End caps
Special feature
Length
16"
24"
36"
48"

96-2 K
1/32" @ 72"
1/32" @ 72"
1 x horizontal 2 x vertical
Anti-slip stopper / Shock absorbing / Removable Impact protection
Part No.
36416
36424
-
-



196-2 K
1/32" @ 72"
1/32" @ 72"
1 x horizontal 2 x vertical
Anti-slip / Shock absorbing / Removable Impact protection, Handholes
Part No.
-
-
36436
36448

Type 80 A-2 - The Measuring Stick



- Three layout scales
- Double sided wall grips
- Uninterrupted frame
- Slope indication rings

Type
Accuracy - top read
Accuracy - bottom read
Vial type
End caps
Special feature

Length
24"
48"



80 A-2
± 1/32" @ 72"
± 3/64" @ 72"
1 x horizontal 2 x vertical
Standard w/ wall grips
Printed Scales

Part No.
29124
29148



Type 80 A-2 / 80 A-2 M

- STABILA's general construction level
- Perfect for tile installers and all job site applications

Type 80 A-2 / 80 A-2 M / 70 A-2

Type
Accuracy - top read
Accuracy - bottom read
Vial type
End caps
Special feature

Length
24"
48"
72"
58" & 32" Combo
48", 24", & Torpedo

80 A-2
± 1/32" @ 72"
± 3/64" @ 72"
1 x horizontal 2 x vertical
Standard
-

Part No.
29024
29048
29072
29532
29824 ProSet

80 A-2 M
± 1/32" @ 72"
± 3/64" @ 72"
1 x horizontal 2 x vertical
Standard
Rare-earth magnets

Part No.
29224
29248
29272
-
29924 Mag. ProSet

70 A-2
± 1/32" @ 72"
± 3/64" @ 72"
1 x horizontal 2 x vertical
Standard
-

Part No.
22924
22948
-
-
-

70 A-2

- STABILA's entry price point

TECH 700 DA

- Functions as an angle finder, a miter gauge, and a classic spirit level.
- Quickly determine and transfer angles from 0° – 270° .
- Digital display lights up.
- LOCK function enables angles to be transferred.
- Two side contact edges for accurate and reliable marking.
- REF function allows users to quickly return to a previously recorded setting.
- Save measured values with the HOLD function.
- Displays the angle bisection at the touch of a button.
- Precise measuring results with an accuracy of $\pm 0.1^{\circ}$.
- Protection class IP 54.
- Includes carrying case.
- 1 digital display, 1 horizontal vial, 1 vertical vial, 2 coated measuring surfaces.



TECH 700 DA - Specifications



Type	TECH 700 DA
Accuracy - top read	$\pm 1/32'' @ 72''$
Accuracy - bottom read	$\pm 3/64'' @ 72''$
Accuracy with electronic inclination measurement	$\pm 0.1^{\circ}$
Measuring range	from 0° to 270°
Vial type	1 x horizontal 1 x vertical
End caps	Standard
Digital mode	Degrees

Length	Part No.
18"	39018
32"	39032

Application



TECH 700 DA: Designed for measuring and transferring angles, e.g. when installing cabinets, aligning built-ins, positioning elaborate tiles, transferring angles when cutting tiles and setting up for precise miter cuts.

Type 106 T - Plate Level®

- Extendable spirit level with strong multi-chamber aluminum frame and removable stand-offs that can reach around braces.
- Plumb vial always at eye level.
- Handholes for comfort and grip.
- Reinforcing ribs for high strength.
- Continuous bridge over horizontal vial increases frame strength.
- Plastic end caps protect the profile against impact.
- Two measuring surfaces for measuring in normal and reverse positions.
- STABILA vial technology delivers long-term accuracy.
- Scales printed on both sides of extension pole for fast set ups.



Application

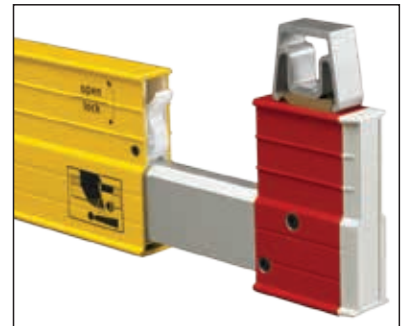

Type 106 T: Removable 1 5/8" stand-offs reach around braces. **Simply twist on and off.**

Especially suitable for wood frame construction and reinforced concrete construction.

Type 106 TM - Magnetic Plate Level®

- Strong rare-earth magnets grab steel. Work hands-free.
- Extendable spirit level with strong 3-chamber frame.
- Plumb vial always at eye level.
- Extremely long measuring surface thanks to a unique telescope system.
- Handholes for comfort and grip.
- Reinforcing ribs for high strength.
- Continuous bridge over horizontal vial increases frame strength.
- Plastic end caps protect the profile against impact.
- Two measuring surfaces for measuring in normal and reverse positions.
- STABILA vial technology delivers long-term accuracy.
- Scales printed on both sides of extension pole for fast set ups.



Type 106 T

Type

Accuracy - top read

Accuracy - bottom read

Vial type

End caps

Special features

Length

6' - 10'

7' - 12'

106 T

± 1/32" @ 72"
± 1/8" @ 120"
(extended)

± 3/64" @ 72"
(closed)

1 x horizontal
2 x vertical

Standard

Telescopic system,
Stand-Offs

Part No.

35610

35712

Type 106 TM

Type

Accuracy - top read

Accuracy - bottom read

Vial type

End caps

Special features

Length

6' - 10'

7' - 12'

106 TM

± 1/32" @ 72"
± 1/8" @ 120"
(extended)

± 3/64" @ 72"
(closed)

1 x horizontal
2 x vertical

Standard

Telescopic system,
rare-earth magnets

Part No.

34610

34712

Application



Type 106 TM: Strong flush mounted rare-earth magnets grab steel. Work hands-free

Type 80 T

- A strong telescopic system for extending the measuring surface enables this spirit level to adjust to various different lengths.
- A continuous marking and cutting edge along the entire length of this level allows users to measure and mark simultaneously.
- Printed scale on the top of the frame helps users determine internal dimensions and clearances.
- Prevent inadvertent adjustments and fix the level at a specific length by using the LOCK feature.
- Anti-slip grips on the back of the level allow for a firm hold on walls.
- German engineered extension mechanism ensures highly accurate measurements. Accuracy tolerances are: ± 0.5 mm/m for normal position, ± 0.75 mm/m for reverse position, and ± 1.0 mm/m when extended.





Application / Additional features



Printed scale to determine internal dimensions and clearances.



Extension LOCK system secures the set length.



Marking and cutting edge along the entire length – measure and mark simultaneously, even when extended.



Anti-slip red grips allow for a firm hold when marking on walls.

Type 80 T - Specifications

Type	80 T
Accuracy - top read	± 1/32" @ 72" ± 1/16" @ 60"(extended)
Accuracy - bottom read	± 3/64" @ 72" ± 1/16" @ 60"(extended)
Vial type	1 x horizontal 1 x vertical
End caps	Anti-slip wall grips
Special features	Telescopic system, LOCK system

Length	Part No.
25" – 41"	29441
36" – 59"	29459

Type 81 S Die-cast Torpedoes

- Tough die-cast aluminum frame with a slender shape, providing a firm grip.
- Big, bright crystal clear vials.
- One precision-milled measuring surface.
- STABILA vial installation technology ensures long-term accuracy – suitable for measuring in normal and upside down position.



Type 81 S Torpedoes - Specifications



Type	81 S Torpedo	81 SM Torpedo	81 SV REM w. 45 Torpedo	81 SV REM w. 360 Torpedo
Accuracy - top read	± 1/32" @ 72"	± 1/32" @ 72"	± 1/32" @ 72"	± 1/32" @ 72"
Accuracy - bottom read	± 3/64" @ 72"	± 3/64" @ 72"	± 3/64" @ 72"	± 3/64" @ 72"
Vial type	1 x horizontal 1 x vertical –	1 x horizontal 1 x vertical –	1 x horizontal 1 x vertical 1 x fixed 45° vial	1 x horizontal 1 x vertical 1 x rotating 360° vial
Special feature	–	Strong rare-earth magnet	Extra-strong rare-earth magnet	Extra-strong rare-earth magnet

Length	Part No.	Part No.	Part No.	Part No.
10"	25010 *	25100	25245	25360

* Non-magnetic

Additional features



Type 81 SV features V-groove rare earth magnets and six-ring vial for 1% and 2% slope measurements.

Pocket PRO Levels

- Professional quality with square edges.
- Measures plumb and level.
- Takes up very little space and can be easily carried.
- Vials are big, bright, and easy to read.
- Designed for properly positioning interior trim, electrical boxes, switch plates, thermostats, warning signs, wall lights and appliances.



Pocket PRO Magnetic - Specifications



Type	Pocket PRO Magnetic
Accuracy - top read	$\pm 1/16'' @ 60''$
Vial type	1 x horizontal
Special features	Rare-earth magnet, Belt Holster

Length	Part No.
1 5/8" x 2 5/8"	11901

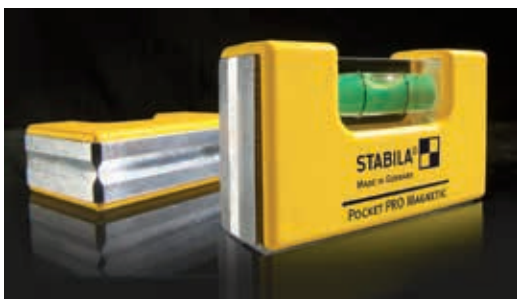

STABILA produces laser measuring equipment for various areas of use.

- Save time**
- Eliminate errors**
- Reduce costs**

Laser levels and laser distance measures (LDMs) are essential tools for any trade in construction due to their high level of accuracy and vast measuring ranges. LDMs are most popular among those desiring accurate, quick, and simple distance measuring. Rotation lasers are suitable for accurate leveling over great distances due to their working range of up to 1,800'.

Rotation lasers can level horizontal, level vertical, and create slopes. Alternatively, point and line lasers are often used at close ranges so marks can be made directly on visible laser lines and points.





Laser recommendations



Civil engineering and pipeline	LAR 350	LA 180 L
Laying out areas		
leveling horizontally	•	•
leveling vertically	•	•
inclination / slope	•	
Transferring heights		
leveling horizontally	•	•



Landscapers and gardeners	LAR 350	LA 180 L
Laying out paths		
leveling horizontally	•	•
inclination / slope	•	
Laying out gardens		
leveling horizontally	•	•
Positioning fences		
leveling horizontally	•	•
leveling vertically	•	•



Steel and concrete workers	LAR 350	LA 180 L
Casing and concreting		
leveling horizontally	•	•
leveling vertically	•	•
inclination / slope	•	
Earthworks		
leveling horizontally	•	•
Stair installation		
leveling horizontally	•	•
leveling vertically	•	•



Bricklayers	LAR 350	LA 180 L
Building walls		
leveling horizontally	•	•
leveling vertically	•	•
right angle (90°)	•	•
Creating the leveling layer		
leveling horizontally	•	•
Concreting		
leveling horizontally	•	•



Carpenters	LAR 350	LA 180 L	LA-5 PG
Positioning frames			
leveling horizontally	•	•	
leveling vertically	•	•	
right angle (90°)	•	•	•
Roof truss construction			
leveling horizontally	•	•	
Mounting cladding and facades			
leveling vertically	•	•	



Metal workers	LAR 350	LA 180 L	LA-5 PG
Positioning steel beams			
leveling horizontally	•	•	
leveling vertically	•	•	
right angle (90°)	•	•	•
Positioning fences			
leveling horizontally	•	•	
leveling vertically	•	•	
Installing balconies & staircases			
leveling horizontally	•	•	
leveling vertically	•	•	
plumb line	•	•	•



Tilers	LAX 400	LAX 50 G	FLS 90
Laying wall tiles			
leveling horizontally	•	•	
leveling vertically	•	•	
Laying floor tiles			
right angle (90°)	•		•



Drywallers	LAX 400	LAX 300 G	LA-5 PG
Marking out partition walls			
right angle (90°)	•		•
Positioning partition walls			
leveling vertically	•	•	
Suspending ceilings			
leveling horizontally	•	•	



Carpenters	LAX 400	LAX 300 G	LAX 50 G
Installing kitchens			
leveling horizontally	•	•	•
leveling vertically	•	•	•
right angle (90°)	•		
Installing stairs			
leveling horizontally	•	•	•
leveling vertically	•	•	•
plumb line	•	•	
Installing windows			
leveling horizontally	•	•	•



Electricians	LAX 400	LAX 300 G	LAX 50 G
Installing switches and plug sockets			
leveling horizontally	•	•	•
Installing cable ducts			
leveling horizontally	•	•	•
leveling vertically	•	•	•
Installing lighting equipment			
leveling horizontally	•	•	•
leveling vertically	•	•	•
plumb line	•	•	
right angle (90°)	•		



Plumbers / heating engineers	LAX 400	LAX 300 G	LAX 50 G
Installing radiators/sanitary fittings			
leveling horizontally	•	•	•
Installing pipes and ducts			
leveling horizontally	•	•	•
leveling vertically	•	•	•
Installing ventilators			
leveling horizontally	•	•	•
leveling vertically	•	•	•
right angle (90°)	•		

Product recommendations for professionals

On construction sites there are many specific measurement jobs that need to be solved. To meet this need, STABILA has compiled a selection of products designed to suit your exact requirements.

You can find all our product recommendations at:
stabila.com

LA 180 L Layout Station

- Establish square layouts more efficiently than ever before.
- Self-leveling motor driven multi-line laser.
- 3 vertical and 1 horizontal continuous laser lines.
- Vertical plumb points up and down.
- **AUTOALIGNMENT** feature enables REC 410 receiver to automatically control the fine alignment of the LA 180 L up to 120'.
- Automatic axis transfer and creation of right angles.
- Pulsed laser lines for exact height measurements with the receiver (up to 300') indoors and outdoors.
- Bright and sharp easy-to-read laser beams for fast and effective direct work on laser lines that are clearly visible at up to 60' indoors.
- Unique housing shape for positioning in corners and over edges (e. g. concrete slab) – rapid checking of right angles.
- Shock-absorbing soft grip casing.
- One man operation.
- Protection certification: IP 54

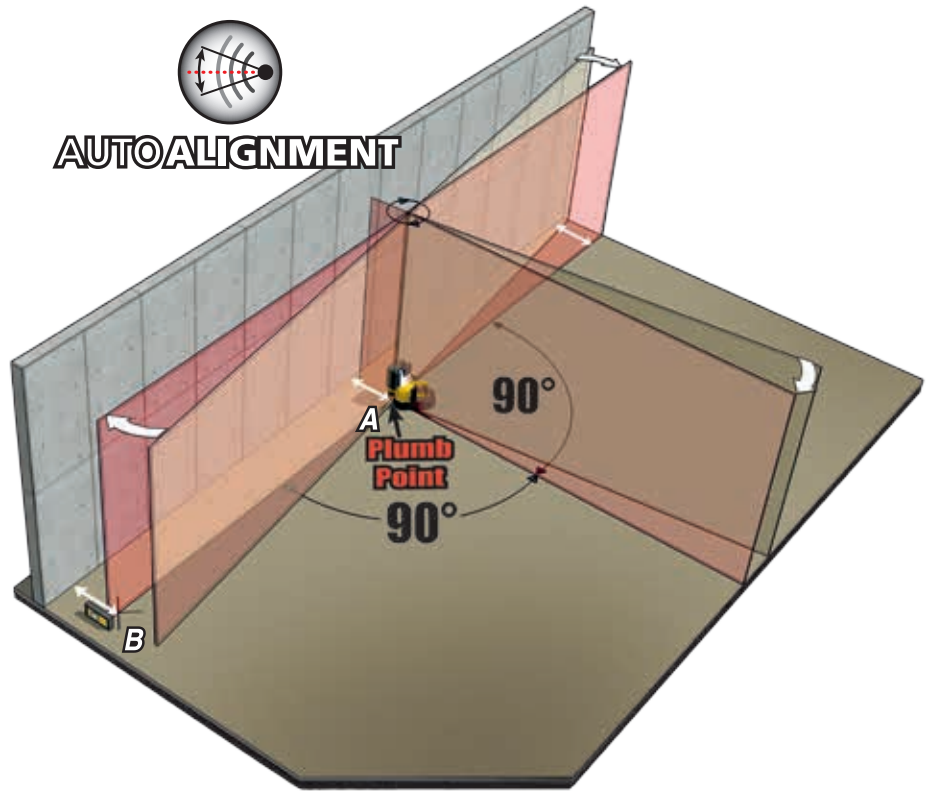

- 1) Mark reference points A and B parallel to the wall.
- 2) Position the laser on point A and the receiver on point B.
- 3) Roughly position the laser by hand.
- 4) Point A and B are automatically connected by pressing the button on the receiver.



LA 180 L Laser Kit - Specifications

Cat #: 02180

Includes: LA180L Laser, REC410 Line RF Receiver with Bracket, Laser Glasses, 2 Magnetic Target Plates, Manual, Batteries, Hard Shell Case.

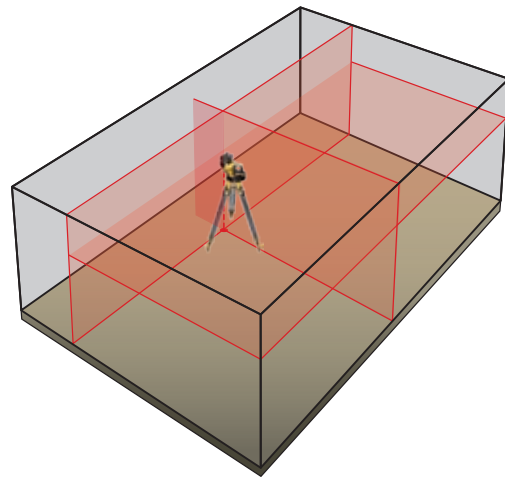

Laser class	Output	Laser wavelength	Self-leveling range	Leveling accuracy	Line straightness	90° angle precision
2	< 1 mW	635 nm	± 5.0°	± 3/32" @ 100'	± 1/8" @ 100'	± 1/4" @ 100'
Laser beam accuracy	Measuring range of visible line	Measuring range of set receiver	Battery life	Batteries included	Protection class	
± 3/32" @ 100'	65'	328'	approx. 20 hours	4 x D 1.5 V	IP 54	

CAUTION LASER RADIATION
 DO NOT STARE INTO BEAM
 630 nm - 660 nm / < 1 mW
 CLASS II LASER PRODUCT
 CFR 1040.10 AND CFR 1040.11

Applications

- **Metal construction** – Erecting metal structures in industrial building construction.
- **Reinforced concrete construction** – Transferring points from batter boards, marking walls on the foundation slab.
- **Bricklaying** – Transferring points from batterboards, marking walls on the foundation slab, marking partition walls in the basement.
- **Carpentry** – Marking and aligning wood frame walls.
- **Drywall construction** – Transferring layouts from the foundation slab to walls and ceilings, setting up and fixing U-profiles, setting partition walls, hanging ceilings.
- **Plumbing and installation work** – Aligning pipe clips, positioning wires, heating pipes.



AUTOALIGNMENT for automatically transferring layout lines and creating right angles



Optional accessory – batterboard and form bracket for the laser: #07410



Optional accessory – rechargeable battery: Power NiMH battery for long periods of use #07000

LAR 350 Rotation Laser

- Features dual slope, interior, exterior, horizontal, vertical, and square leveling functions.
- Fully automatic motor-driven rotation laser for horizontal and vertical applications as well as manual inclination in two planes.
- Innovative MOTION CONTROL – quick, reliable and convenient laser operation by rotating the remote control.
- DUAL SLOPE – working area which can be limited as required in rotation mode. The laser beam is only emitted in a defined area.
- SECTION/MASKING MODE – working area which can be limited as required in rotation mode. The laser beam is only "On" in a defined area.
- LED ASSIST system – for easy operation and safety in the workplace. Integrated LEDs indicate, for example, which axis is currently tilted or is being tilted.
- **MANUAL ALIGNMENT** function – pivoting an axis in vertical operation.
- Patented STABILA PROTECTOR system – extreme drop protection, even when the laser is dropped from a tripod at a height of up to 6'.
- Waterproof and dust proof in accordance with protection Class IP 65.
- Large working area with REC 300 Digital Receiver, up to 2,600' in diameter.



Applications

- **Bricklaying** – creating the leveling layer
- **Reinforced concrete construction** – foundations or constructing batter boards
- **Metal construction** – aligning and positioning steel beams in industrial building construction
- **Hardscaping work** – laying out garden areas, paths and paving
- **Carpentry construction** – attaching siding
- **Civil engineering and pipeline construction** – installing pipelines



LAR 350 Rotation Laser Kit - Specifications

Cat #: 05700 TR

Includes: LAR350 Laser, DeTech Receiver with Clamp, Motion Control Remote, Fixed Head Tripod, Elevation Rod, Target Plate, Laser Glasses, Manual, Batteries, Hard Shell Case.



Laser class	Output	Laser wavelength	Self-leveling range horizontal + vertical	Leveling accuracy	Working area of set receiver
2	< 1 mW	635 nm	approx. ± 5°	± 1/8" @ 100'	2,600'



Operating life accuracy	Batteries included	Protection class
approx. 80 hours	2 x D 1.5 V - 4 x AA 1.5 V	IP 65



Optional accessory – AE-LAR350 Li-ion rechargeable battery unit: Li-ion rechargeable battery, mains adapter, 4 country-specific interchangeable adapters #07150





World's first MOTION CONTROL Laser



STABILA DROP PROTECTION – Set it up again after a fall, switch it on, and continue working.



Colored LED light assistance.



MOTIONCONTROL



MOTION CONTROL – an intuitive remote control with a built-in motion sensor. By moving the remote control left or right, the motion sensor accelerates or decelerates the chosen laser function. Intuitively control numerous functions and settings at a measuring range of up to 60'.

LAR 200 Rotation Laser

- Fully automatic motor-driven rotation laser for horizontal applications.
- Large working area with REC 300 digital receiver, up to 1,800' in diameter.
- 600 rpm rotation speed.
- Features plumb function.
- Patented STABILA PROTECTOR system – extreme drop protection, even when the laser is dropped from a tripod at a height of up to 6'.
- Can effectively operate from -10°C (14°F) to 60°C (140°F).
- Colored LED light assistance.
- Waterproof and dustproof in accordance with protection class IP 65.



STABILA DROP PROTECTION – Set it up again after a fall, switch it on, and continue working.



LAR 200 Laser Kit - Specifications

Cat #: 05500 TR

Includes: LAR 200 Rotating Laser,
REC 300 digital receiver with clamp, fixed head tripod,
Hi/Lo elevation rod, batteries, manual, hard shell case



CAUTION LASER RADIATION
DO NOT STARE INTO BEAM
< 5mW @ 633nm - 670nm
CLASS IIIa LASER PRODUCT

Laser class	Output	Laser wavelength	Self-leveling range horizontal + vertical	Horizontal leveling accuracy	Diameter receiver range	Battery life	Batteries included	Protection class
2	< 1 mW	650 nm	± 5°	± 1/8" @ 100'	1,800' / 550m	120 hours	2 x D	IP 65

LAX 50 G Cross Line Laser with Pole

- Easy to use, one button simple.
- Laser connects onto pole at any height.
- Pole extends to 9' -6". (included)
- Self-leveling cross line laser with crisp green cross lines up to 60'.
- Work quickly and directly on the fine laser lines using STABILA GreenBEAM technology.
- Energy saving laser diodes enable a constant on operating time of up to 7 hours.
- Pendulum technology built for the job site.
- Rotating multi-purpose base for positioning the laser onto the floor or tripods (1/4" and 5/8" threads).
- Strong rare-earth magnet for securely attaching to metal.
- Protection certification: IP 54



Put the laser where you need it – mounts to the pole, not your work

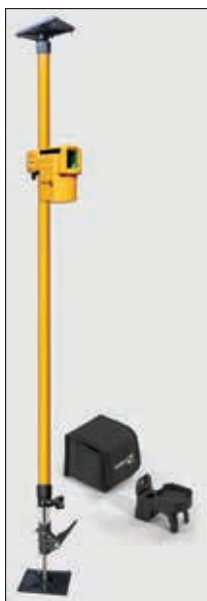

LAX 50 G Laser Kit - Specifications

Cat #: 03265 GP
Includes: LAX 50 G Laser, telescopic pole, multi-purpose base, carrying pouch



- Remodel work
- New construction
- Trim
- Wall tile
- Drywall
- Cabinets
- Wall paper
- Paint
- Wainscot panels
- Closet systems
- Glazers
- Framing
- Ceilings

Laser class	Output	Laser wavelength	Leveling accuracy	Measuring range of visible line	Battery life constant on	Protection class
2	< 1 mW	510-530 nm	± 3/16" @ 25'	100'	7 hours	IP54

CAUTION LASER RADIATION
DO NOT STARE INTO BEAM
510 nm - 530 nm / < 1 mW
CLASS II LASER PRODUCT
1040.10 AND CFR 1040.11

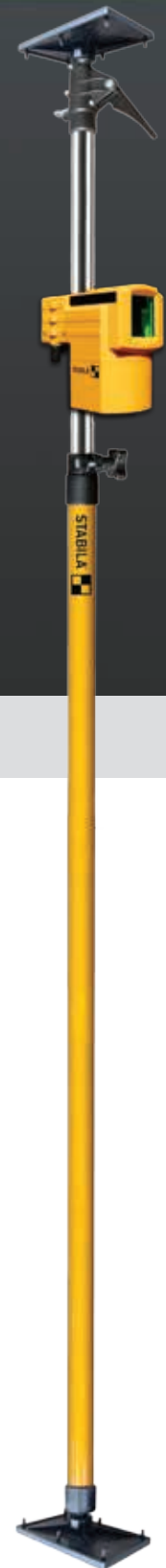

LAX 300 G Cross Line and Plumb Points Laser

- Bright and sharp green cross lines visible up to 100' indoors.
- Intense green plumb points up and down, can be seen outdoors.
- Work quickly and directly on the laser lines using STABILA GreenBEAM technology.
- Energy saving laser diodes enable an operating time of up to 15 hours when both beams are engaged and an operating time of up to 20 hours when only one beam is engaged.
- Pendulum technology built for the job site.
- Easy to change functions with single-button.
- Features many different positioning options. The LAX 300 G can be placed directly onto the floor, mounted onto any 1/4" thread tripod, attached to any metal surfaces via its built-in V-groove magnet, and fastened to walls with its wall bracket.
- Laser rotates inside housing for built-in protection.
- Protection certification: IP 54

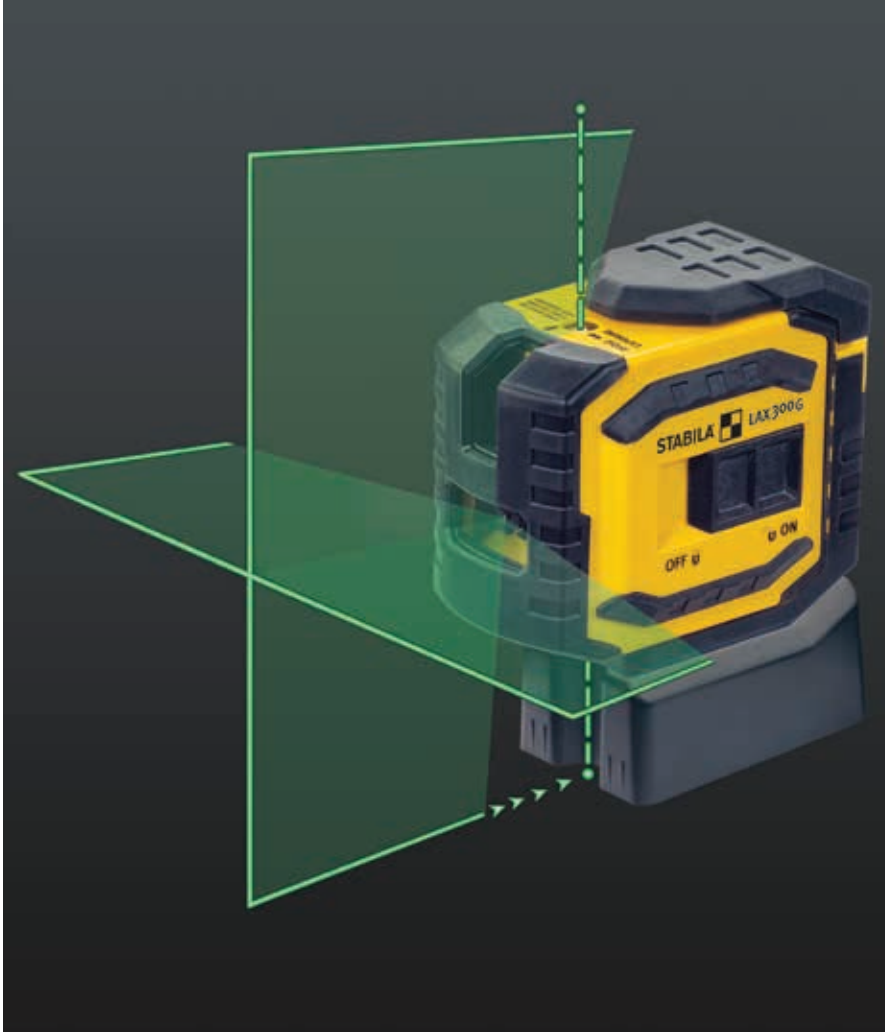

Optimum visibility – crisp laser lines over the working surface.



LAX 300 G Laser Kit - Specifications

Cat #: 03185

Includes: LAX 300 G Laser, framing base (#07471), target plate, wall bracket, carrying belt pouch

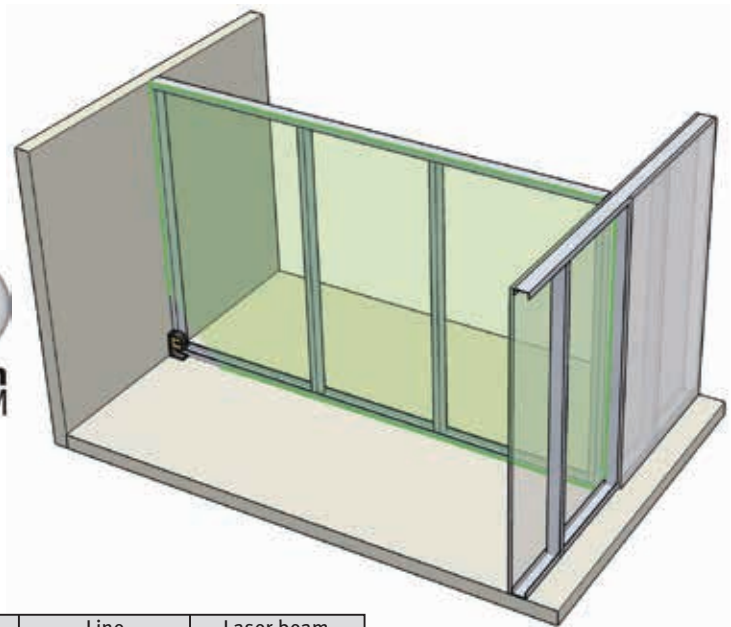

Laser class	Output	Laser wavelength	Self-leveling range	Leveling accuracy	Line straightness	Laser beam accuracy (up)
2	< 1 mW	510-530 nm	± 4.5°	± 3/16" @ 50'	± 1/8" @ 50'	± 3/16" @ 50'

Laser beam accuracy (down)	Measuring range of visible line	Battery life (1 beam)	Batteries included	Protection class
± 1/4" @ 50'	100'	20 hours	3 x AA 1.5 V	IP 54

CAUTION LASER RADIATION
 DO NOT STARE INTO BEAM
 510 nm - 530 nm / < 1 mW
 CLASS II LASER PRODUCT
 CFR 1040.10 AND CFR 1040.11

LA-5P G 5-Point Layout Laser

- 5 crisp green laser dots clearly visible at up to 60' indoors.
- Plumb points up and down for transferring layout points from floor to ceiling.
- With the 90° points, two right angles are created.
- Work quickly and directly on the fine laser points using STABILA GreenBEAM technology.
- Energy saving laser diodes enable an operating time of up to 15 hours.
- Pendulum technology built for the job site.
- Easily change functions with a single button.
- Features many different positioning options. The LA-5P G can be placed directly onto the floor, mounted onto any 1/4" thread tripod, attached to any metal surfaces via its built-in V-groove magnet, and fastened to walls with its wall bracket.
- Laser rotates inside housing for built-in protection.
- Protection certification: IP 54



Optimum visibility – perfect setting of 90° angles and transferring layout points



LA-5P G Laser Kit - Specifications

Cat #: 03165
Includes: LA-5P G Laser, framing base (#07471), target plate, wall bracket, carrying belt pouch

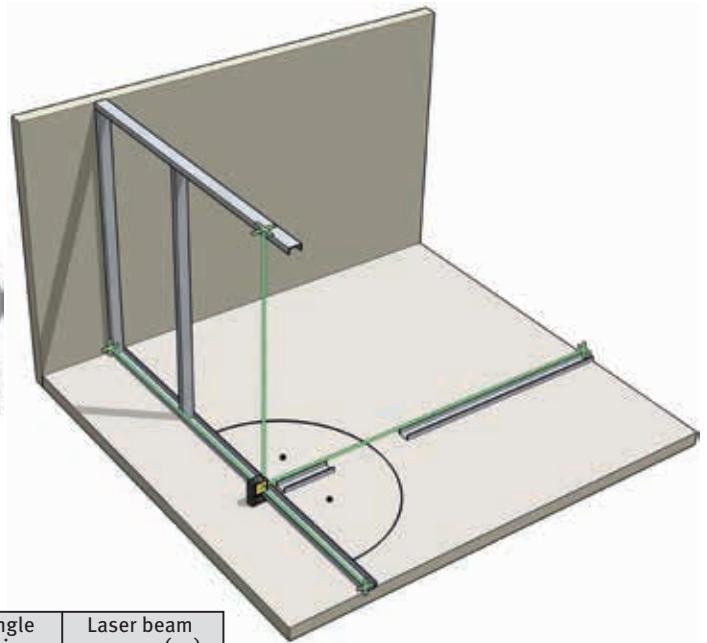

Laser class	Output	Laser wavelength	Self-leveling range	Leveling accuracy	90° angle precision	Laser beam accuracy (up)
2	< 1 mW	510-530 nm	± 4.5°	± 3/16" @ 50'	± 1/8" @ 50'	± 3/16" @ 50'

Laser beam accuracy (down)	Measuring range of visible point	Battery life	Batteries included	Protection class
± 1/4" @ 50'	60'	15 hours	3 x AA 1.5 V	IP 54

CAUTION LASER RADIATION
DO NOT STARE INTO BEAM
510 nm - 530 nm / < 1 mW
CLASS II LASER PRODUCT
CFR 1040.10 AND CFR 1040.11

LAX 400 Multi-line Laser

- Multi-line red laser with a 360°
- **MANUALALIGNMENT:** fine adjustment knob pivots the right angle left and right.
- Built-in vertical elevation height adjustment.
- The laser pivots 360° inside the housing.
- Pulsed laser lines for use with optional receiver. (#07335)
- Features many different positioning options. The LAX 400 can be placed directly onto the floor, mounted onto any 5/8" thread tripod, attached to any metal surfaces via its built-in V-groove magnet, and fastened to walls with its wall bracket.
- Protection certification: IP 54



- 360° horizontal line covers the entire room.
- Magnetic V-groove sticks to metal.



MANUALALIGNMENT fine adjustment knob adjusts the position of the 2 vertical lines



LAX 400 Laser Kit - Specifications

Cat #: 03360

Includes: LAX400 Mult-Line Laser, Target Plate, Wall Bracket, Laser Glasses, Batteries, Manual, Kit Box

Optional accessory:

REC 220 receiver (part #07335)



Two adjustable feet aligns laser to track

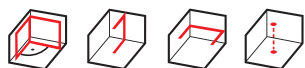

Laser class	Output	Laser wavelength	Self-leveling range	Leveling accuracy	Line straightness	90° angle precision
2	< 1 mW	635 nm	± 4°	± 3/16" @ 50'	± 1/8" @ 50'	± 3/16" @ 50'

Laser beam accuracy	Measuring range of visible line	Battery life	Batteries included	Protection class
± 3/16" @ 50'	60'	10 hours	4 x AA 1.5 V	IP 54

CAUTION LASER RADIATION
DO NOT STARE INTO BEAM
630 nm - 660 nm / < 1 mW
CLASS II LASER PRODUCT
CFR 1040.10 AND CFR 1040.11

FLS 90 Floor Line Laser

- Compact housing designed to position the tool inside corners to quickly check for square.
- Patented STABILA optics deliver bright square lines that can easily be seen at up to 50' indoors.
- Can be used with Stabila REC210 audio receiver to extend usable range to 490'. (#07335)
- Unique dual purpose base allows laser to grip tile and transfer 90°.



On tiles position claws downward



On flat surfaces position claws upward



Positions inside corners to check for square



FLS 90 Laser Kit - Specifications

Cat #: 04490

Includes: Target Plate for easier daylight use, dual purpose base and belt pouch carrying case

Optional accessory:
REC 220 receiver (part #07335)



Laser class	Output	Laser wavelength	90° angle precision	Measuring range of visible line
2	< 1 mW	635 nm	± 3/16" @ 50'	50'

Battery life	Batteries included	Protection class
20 hours	3x AA 1.5 V	IP 54

CAUTION LASER RADIATION
DO NOT STARE INTO BEAM
630 nm - 660 nm / < 1 mW
CLASS II LASER PRODUCT
CFR 1040.10 AND CFR 1040.11

Laser distance measurer: Overview of functions

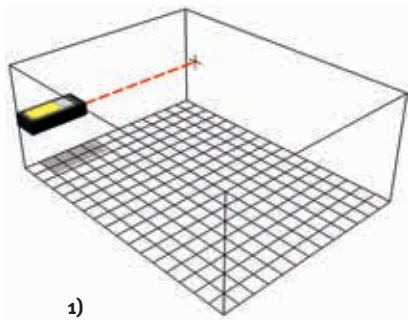

1)

LD	220	250	520
----	-----	-----	-----

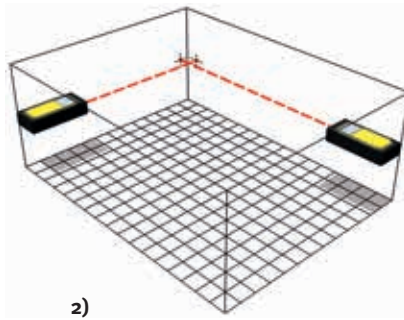

2)

LD	220	250	520
----	-----	-----	-----

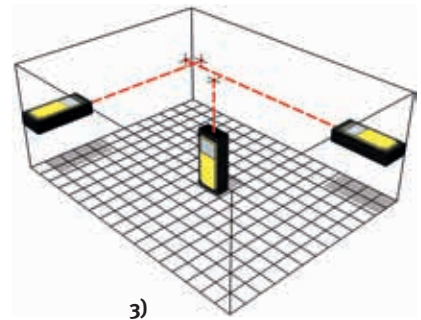

3)

LD	220	250	520
----	-----	-----	-----

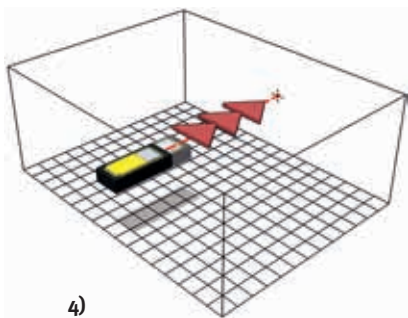

4)

LD	220	250	520
----	-----	-----	-----

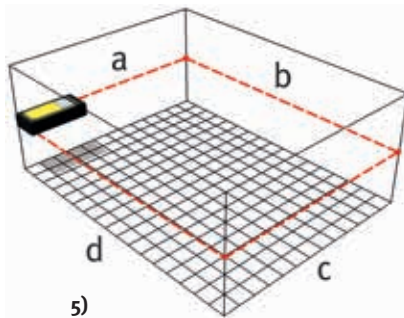

5)

LD	-	-	520
----	---	---	-----

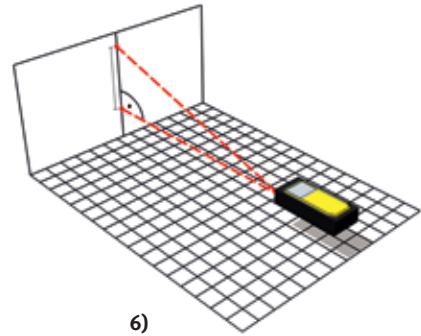

6)

LD	-	-	520
----	---	---	-----

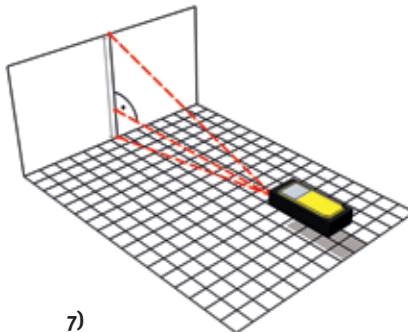

7)

LD	-	-	520
----	---	---	-----

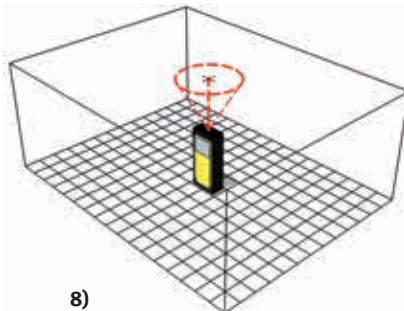

8)

LD	-	-	520
----	---	---	-----

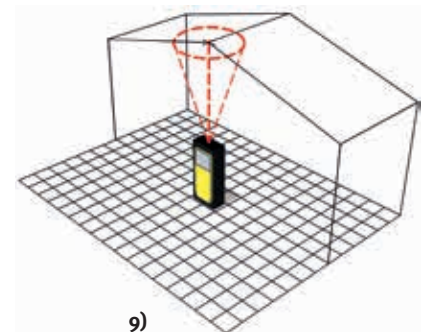

9)

LD	-	-	520
----	---	---	-----

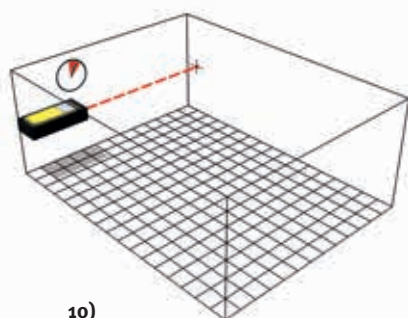

10)

LD	-	-	520
----	---	---	-----

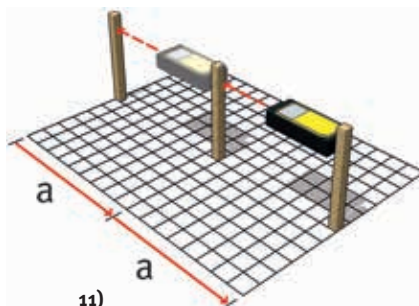

11)

LD	-	-	520
----	---	---	-----

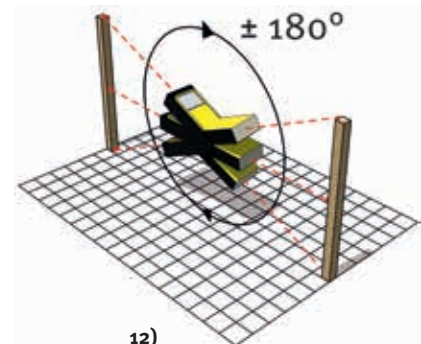

12)

LD	-	-	520
----	---	---	-----

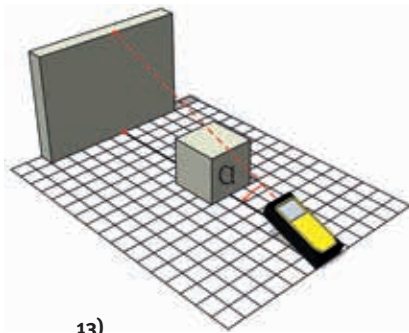

13)

LD	-	-	520
----	---	---	-----

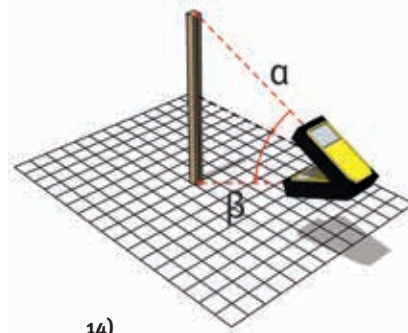

14)

LD	-	-	520
----	---	---	-----

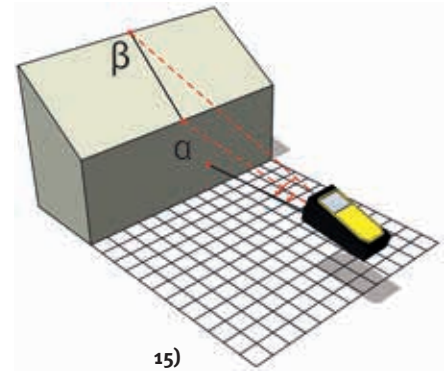

15)

LD	-	-	520
----	---	---	-----

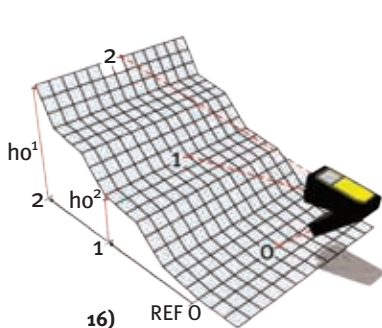

16)

REF 0

LD	-	-	520
----	---	---	-----

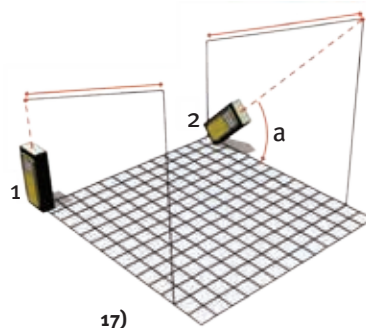

17)

LD	-	-	520
----	---	---	-----

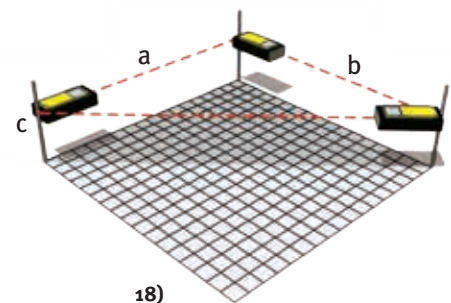

18)

LD	-	-	520
----	---	---	-----

- 1) Length measurement
- 2) Area measurement
- 3) Volume measurement
- 4) Continuous measurement
- 5) Chain dimensions
- 6) Pythagoras function 1: Determines a distance using two related measurements.
- 7) Pythagoras function 2: Determines a distance using three related measurements.
- 8) Minimum tracking: Minimum continuous measurement to determine (e.g. the minimum diagonal measurement).
- 9) Maximum Tracking: Maximum continuous measurement to determine (e.g. the maximum diagonal measurement).
- 10) Timer: Self-timer function (e.g. for shake-free measurements on a tripod).
- 11) Stake out distances
- 12) Inclination measurement: Inclination sensor measures inclinations in a range of $\pm 180^\circ$.
- 13) Indirect distance measurement: Allows measurement of a horizontal line that cannot be directly accessed.
- 14) Indirect height measurement: Determines a height (e.g. of a building) that does not offer a suitable reflection point.
- 15) Measurement of inclined objects: Enables inclined distances that are not directly accessible to be measured (e.g. the slope of a roof).
- 16) Elevation profile measurement: Determines the difference in height between a reference point and other measurement points.
- 17) Trapezoidal measurement: Allows measurement of oblique lines that are not directly accessible.
- 18) Triangular area measurement: Calculates the area of a triangle by measuring the sides of the triangle.

LD 520 Laser Distance Measurer

- Camera with high image resolution for long range and outdoor measuring.
- High-contrast 2.4" color display.
- Digital target feature with crosshairs and 4x zoom.
- Integrated Bluetooth® Smart 4.0 technology for transferring measurement data.
- 360° inclination sensor for flexible measurements and positioning.
- Memory function saves previous measurements.
- Comprehensive function package – 18 functions (including MIN and MAX tracking, indirect distances and heights, and elevation profiles).
- Free STABILA Measures app lets you transfer measurements directly to photos or drawings.
- ISO-certified distance measurer adheres to international standard ISO 16331-1.
- Can mount to 1/4" thread tripods.
- Built-in calculator
- Protection certification: IP 54



Measure distances up to 660' away outdoors



LD 520 Laser Measurer Kit - Specifications
 Cat #: 06520
 Includes: Belt pouch and wrist strap



The STABILA Measures app saves time when taking measurements and preparing quotes. This app features an intuitive interface and a wide range of functions. Use the STABILA Measures app to make sketches, take pictures, or draw blueprints on a mobile device and directly transfer measurements over to the app from a LD 520. This direct measurement transfer feature enables users to document and communicate more efficiently.

Laser class	Output	Laser wavelength	Accuracy	Measuring distance
2	< 1 mW	635 nm	± 1/16"	660'
Battery Life		Batteries included	Protection	
up to 5,000 measurements		2 x AA	IP 54	

CAUTION LASER RADIATION
 DO NOT STARE INTO BEAM
 630 nm - 660 nm / < 1 mW
 CLASS II LASER PRODUCT
 CFR 1040.10 AND CFR 1040.11



LD 250 BT Laser Distance Measurer

- Measure distances up to 165' away.
- Compact and easy-to-use laser distance measurer.
- Integrated Bluetooth® Smart 4.0 technology enables measurement data to be wirelessly transferred from the laser to a mobile device.
- Four measurement functions: length, area, volume, and continuous measurement mode.
- Large digits and backlit display make the LD 250 very easy to read.
- ISO-certified distance measurer adheres to international standard ISO 16331-1.
- Free STABILA Measures app lets users transfer measurements directly to an image or a sketch on a mobile device.
- The LD 250 delivers very fast measurement results, which assists users in their daily work (e.g. when calculating how much material is needed).
- Protection certification: IP 54



**LD 250 BT
Laser Measurer -
Specifications**
Cat #: 06250

Laser class	Output	Laser wavelength	Accuracy	Measuring distance
2	< 1 mW	635 nm	± 3/32"	165'

Battery Life	Batteries included	Protection
up to 5,000 measurements	2 x AAA	IP 54



**LD 220
Laser Measurer -
Specifications**
Cat #: 06220



Laser class	Output	Laser wavelength	Accuracy	Measuring distance
2	< 1 mW	635 nm	± 1/8"	100'

Battery Life	Batteries included	Protection
up to 5,000 measurements	2 x AAA	IP 54



LD 220 Laser Distance Measurer

- Measure distances up to 100' away.
- The LD 220 delivers very fast measurement results, which assists users in their daily work (e.g. when calculating how much material is needed).
- Four measurement functions: length, area, volume, and continuous measurement mode.
- ISO-certified distance measurer adheres to international standard ISO 16331-1.

Expanding the working area



RADIO FREQUENCY "RF" AUTOALIGNMENT



REC 410 RF Digital Line Receiver
Part No. 07350

- **AUTOALIGNMENT:** REC 410 receiver uses radio frequency to control the LA 180 L Laser.
- Working leveling range of up to 300'.
- Features visual and acoustic guidance.
- Double-sided digital display for fast work.
- Dust and water proof: IP 54
- Bracket for attaching to grade rods.
- Working leveling range: 300'



REC 300 Digital Receiver
Part No. 07430

- Digital receiver for rotation lasers with red diodes.
- Double-sided digital display for fast work.
- Features visual and acoustic guidance.
- Digital read-out shows exact distance from grade in imperial or metric units.
- Completely waterproof and dustproof protection class IP 67.
- Bracket for attaching to grade rods.
- Can withstand drops of up to 10'.



REC 150 Digital Receiver
Part No. 07460

- Digital receiver for rotation lasers with red diodes.
- Double-sided digital display for fast work.
- Features visual and acoustic guidance.
- Completely waterproof and dustproof protection class IP 67.
- Bracket for attaching to grade rods



REC 220 Digital Line Receiver
Part No. 07335

- Receiver for line lasers with red diodes.
- Display on the front and LED indicator on the side for reading from any position
- Features visual and acoustic guidance.
- Completely waterproof and dustproof protection class IP 67.
- Features imbedded magnets.
- Bracket for attaching to grade rods



Series BST-K-M lifting column construction tripod 28" - 66"

Part No. 08560

- Aluminum construction tripod with lifting column – exact positioning of the laser at the desired working height
- Lift system enables air-cushioned movement
- Tripod legs have spikes to insure good stability outdoors and rotatable hard rubber shoes to prevent scratches when used indoors
- Rapid locking mechanism
- 5/8" threaded screw



BST-S construction tripod 39" - 63"

Part No. 07498

- Aluminum construction tripod
- Tripod legs have spikes to insure good stability
- Rapid locking mechanism for aligning quickly
- Spread stopper chain
- Carrying pouch for easy transport
- 5/8" threaded screw

BM 40 tape measures



Resistant Coating



Scale on 2 sides



Non-Slip Hook



Rocker Blade Lock

- The wide, smooth underside of the housing provides outstanding stability
- The straight rear side of the housing ensures a clean stop and allows working hands-free
- Metal belt clip

Length	16'	27'	33'	5 m / 16'	8 m / 27'	10 m / 33'
Part No.	30316	30327	30333	30416	30427	30433

Series 600 folding rules

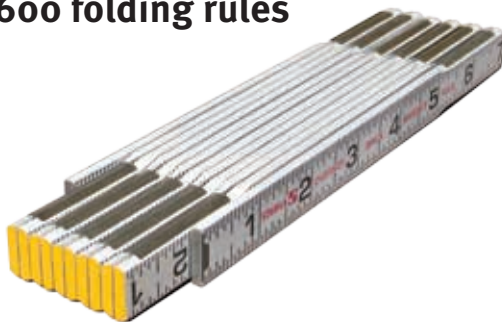

- Hardened steel springs and steel joints ensure durability, smoothness and exact locking
- Fully sealed rivets with abrasion protection
- Large digits for better readability

Type	Description	Part No.
Masons	1/16ths - both edges - outside	80001
Oversize Brick	1/16ths - both edges - outside	80005
Modular Spacing	1/16ths - both edges - outside	80010
Engineers	1/16ths - 1/10ths - 1/100ths	80015

STABILA, Inc.

332 Industrial Drive

P.O. Box 402

South Elgin, IL 60177-0402

Phone: 800.869.7460

In IL: 847.488.0050

Fax: 847.488.0051

E-mail: custservice@stabila.com

stabila.com

Specifications and products are subject to change without notice.
STABILA is not responsible for typographical errors.

Printed in the U.S.A. - October 2018