

Carlton®

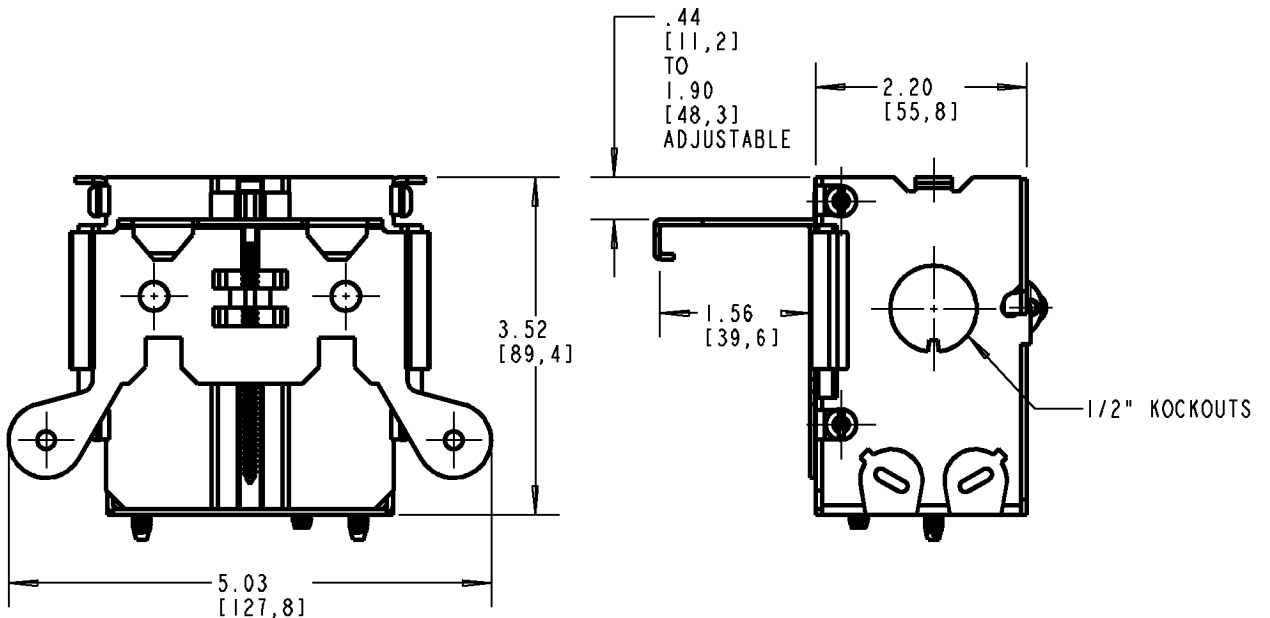
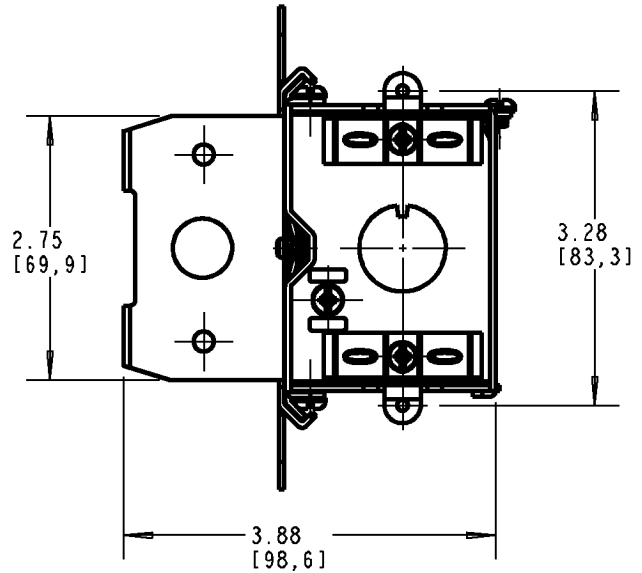
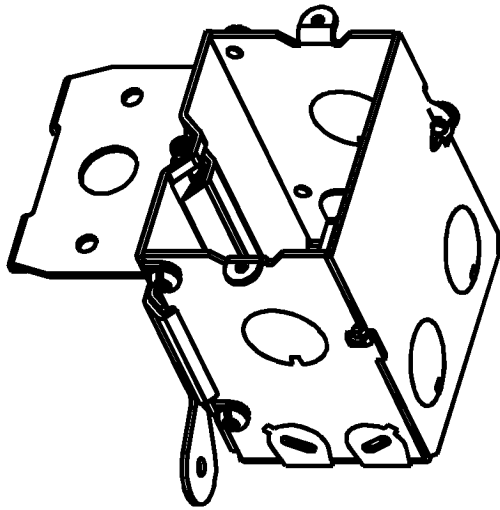

NOTES:

1. BOXES ARE ZINC COATED.

P/N MB120ADJ

GENERAL NOTES

1. ALL DIMENSIONS ARE FOR REFERENCE ONLY.
2. DIMENSIONS IN BRACKETS [] ARE IN METRIC UNITS.

REVISIONS

*** SEE ERN (****) FOR APPROVAL SIGNATURES & RELEASE DATE.
PROJECT NO: ****

Thomas & Betts
www.tnb.com

DESCRIPTION: **1 GANG METAL ADJUST-A-BOX**

ORIGINAL PROJECT NO / (ERN NO)

/ ()

SHEET NO:

1 OF 1

REV. NO:

A

DRAWING NO:

WSD-AC04888