

MODERN

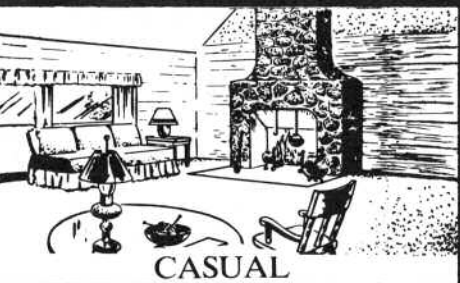

TRADITIONAL



CASUAL

FIREPLACE THROAT DAMPERS



CAST IRON
POKER CONTROL

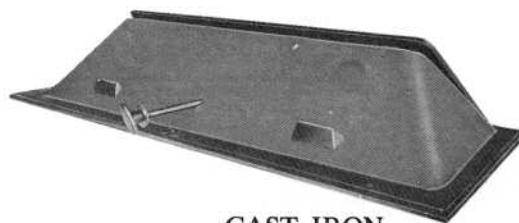

CAST IRON
ROTARY CONTROL

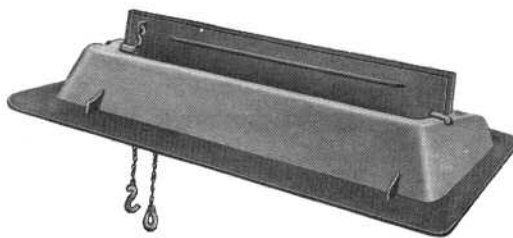

CAST IRON
CHAIN CONTROL



ALL STEEL
POKER CONTROL

INSIST ON THE BEST CAST IRON DAMPERS FOR PERMANENCE

Please
READ
Carefully

Important
**INSTALLATION
INSTRUCTIONS**

VESTAL MANUFACTURING

P.O. Box 420/Sweetwater, Tennessee 37874
423-337-6125

FIREPLACE CONSTRUCTION

GENERAL PRINCIPLES

DETAILS AND DIMENSIONS

Drawings below show details of the different parts of the fireplace. Circled letters are keyed to table dimensions at bottom of page, which gives the proper dimensions (in inches) of the different parts for fireplaces of various typical sizes.

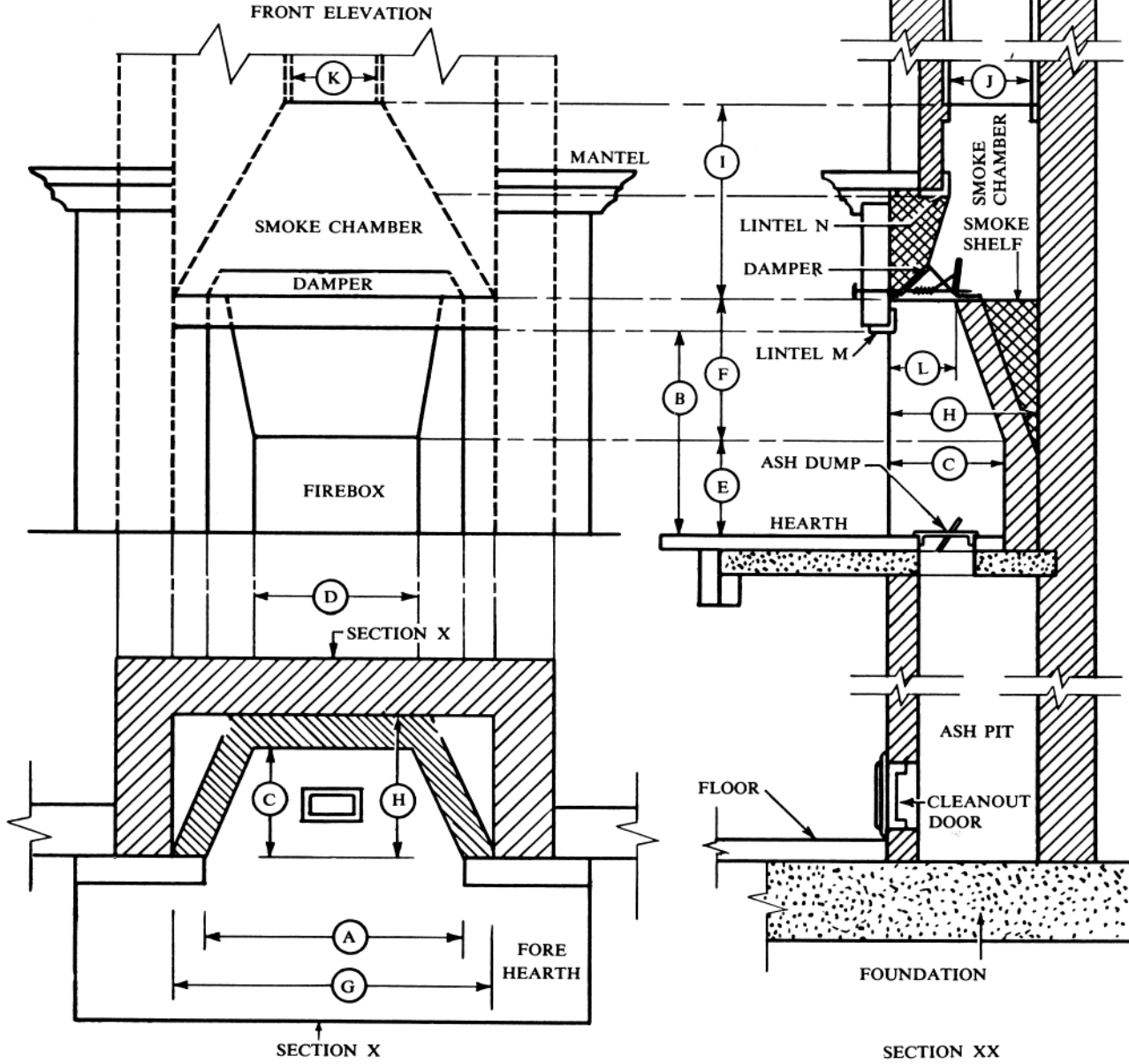
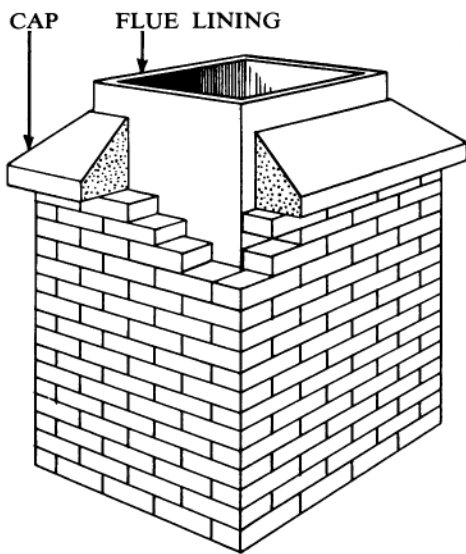

TABLE OF STANDARD SIZE FIREPLACE DIMENSIONS IN INCHES

Finished Fireplace Opening						Rough Dimensions			Flue Lining Size		VESTAL MANUFACTURING COMPANY										
									Old Rectangular	New Modular	Damper Model		Damper Model		Damper Model		Ash Dump	Clean Out Door	Lintels		
A	B	C	D	E	F	G	H	I	J x K	J x K	Poker	Rotary	L	Chain	L	Steel			L	M	N
24	24	16	11	14	15	32	20	19	8½ x 13	8 x 12	24	124	10¼					49	88	36	42
30	29	16	17	14	20	38	20	24	8½ x 13	12 x 12	30	130	10¼					49	88	42	48
33	29	16	20	14	20	41	20	24	13 x 13	12 x 16	33	133	10¼					49	108	42	54
36	29	16	23	14	21	44	20	27	13 x 13	12 x 16	36	136	10¼	836	9¼	636	9	49	108	48	54
42	32	16	29	14	23	50	20	32	13 x 13	16 x 16	42	142	10¼	842	9¼	642	9	49	1210	54	60
48	32	18	34	14	23	56	22	37	13 x 18	16 x 16	48	148	10¼					49	1210	60	66
54	36	20	37	16	26	62	24	44	13 x 18	16 x 20	54	154	10¼					49	1210	66	72
60	38	22	42	16	28	68	26	45	18 x 18	16 x 20	60	160	11¾					49	1212	72	78
72	40	22	54	16	29	80	26	54	20 x 20	20 x 24	72	172	11¾					49	1212	84	90



FLUE LINING:

The custom of using clay flue lining has now become almost universal. Building codes in many localities require clay flue lining for their fire safety features. To obtain an efficient flue the ends of sections of the flue lining should be neatly joined together where they meet, the mortar joints should be smooth. When more than one flue is in the chimney, it is often necessary to off-set one of the flues. Such necessary off-sets in a flue should be no more than 25° from the vertical. It is good construction practice to carry the flue lining 3" to 4" above the cap of the chimney.

The table below gives the net inside cross section area in square inches for the three common kinds of clay flue lining. This table will serve as a convenient guide for determining flue capacities when designing fireplaces.

TABLE: FOR AREA OF CLAY FLUE LININGS (INSIDE MINIMUM NET AREA SQUARE INCHES)

Standard Rectangular		Modular Rectangular		Round	
Outside Dimensions	Net Inside Area Sq. In.	Nominal Outside Dimen.	Net Inside Area Sq. In.	Inside Diameter	Net Inside Area Sq. In.
8½" x 8½"	52.5	8" x 8"	35	6"	28.27
8½" x 13"	80.5	8" x 12"	57	8"	50.26
8½" x 17¾"	109.6	8" x 16"	74	10"	78.54
13" x 13"	126.5	12" x 12"	87	12"	113
13" x 17¾"	182.8	12" x 16"	120	15"	176.7
18" x 18"	248	16" x 16"	162	18"	254
20" x 20"	298	16" x 20"	208	21"	346
20" x 24"	416	20" x 20"	262	24"	452
24" x 24"	441	20" x 24"	320	27"	572
		24" x 24"	385	30"	706

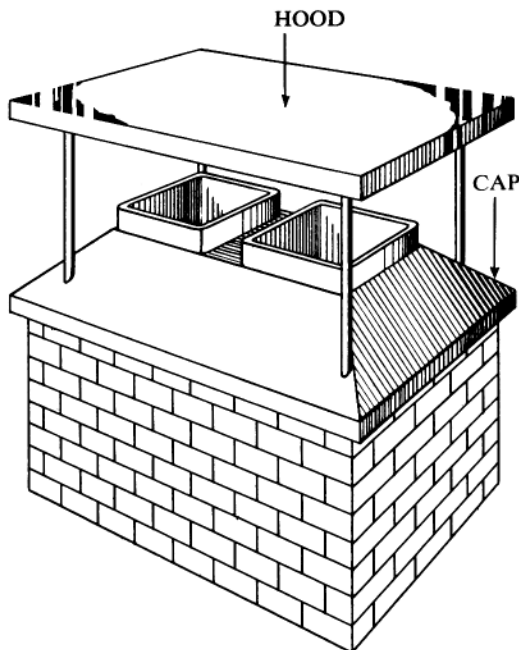

CAP:

The brick, stone or other masonry material used to construct the chimney should be capped at the top with mortar or concrete. Concrete is preferred. The cap keeps the weather from penetrating any cracks in the masonry and reduces chimney maintenance. The surface of the cap should slope downward from the flue linings to the outer edges to provide drainage.

HOOD:

The hood or chimney cap is optional and is left off many fireplaces: it prohibits rain and snow from falling down the flue, it serves as a spark arrestor, it keeps birds out of the chimney and it eliminates drafts and wind puffs from blowing down the flue. If a hood is constructed, the area of the hood openings must exceed the area of the flue linings.

It is common building practice to have more than one flue in the same chimney. If this is the case, dimensions for foundation and chimney walls must be increased to allow for the additional flue(s).

TYPICAL CONSTRUCTION DETAILS FOR CONVENTIONAL FIREPLACES (one side only open)

A successful fireplace will burn brightly and cheerfully, and discharge heat into the room with complete freedom of smoke. The information and tables in this brochure are offered by Vestal Manufacturing Company as a guide for typical fireplace construction. FOR SPECIFIC DETAILS CONSULT YOUR ARCHITECT.

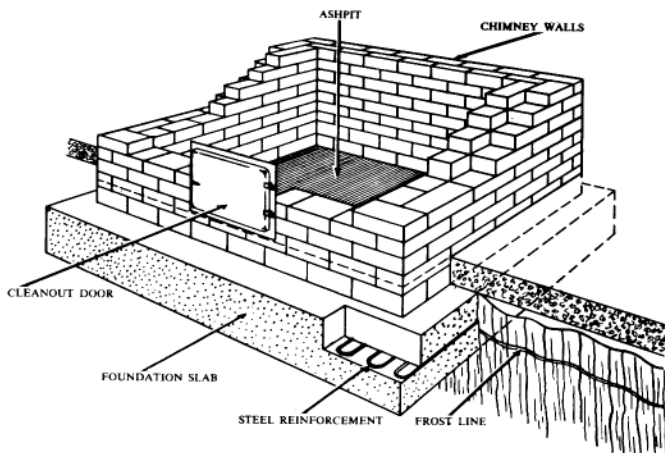

FOUNDATION:

Because of the heavier weight of a chimney compared to the adjoining walls, common in residential construction, a larger and heavier footing is required underneath the chimney. The foundation is generally poured of concrete, and is required for residences with or without a basement. It is a good idea to reinforce the foundation slab with steel. Reinforcing steel rods or reinforcing concrete wire mesh should be used and put in place approximately half way up in the foundation slab. If the chimney is on an exterior wall the foundation must extend well below the frost line. The depth frost penetrates and the bearing capacity of different soils vary with the locality. An experienced builder or architect should be consulted for the depth frost penetrates the soil. The foundation should extend at least six inches outside the dimensions of the chimney walls. Pour the foundation slab level and allow time to cure before starting the masonry work.

ASHPIT:

Is the hollow space below the hearth into which ashes fall for storage until their removal. The ashes fall through a pivoted metal door (Ash Dump) located in the hearth. It is necessary to provide an access door (Cleanout Door) into the ashpit for the removal of ashes when the ashpit becomes full.

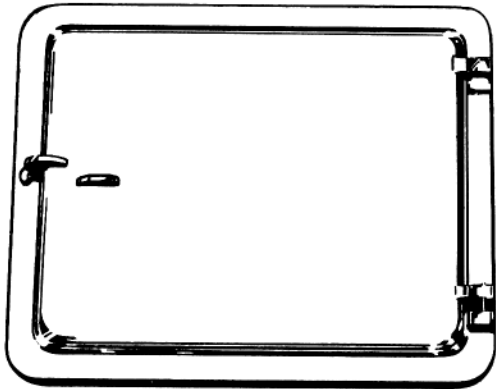

CLEANOUT DOOR:

It is necessary to provide an opening into the ashpit as a means to remove the accumulation of ashes. The door should be of metal and close tightly. Doors made of long lasting cast iron have much more resistance than steel doors to the acidic condition found in ashes and to the elements.

VESTAL OFFERS CAST IRON AND STEEL DOORS OF VARIOUS SIZES.
OUTSIDE AIR MODELS ARE ALSO AVAILABLE

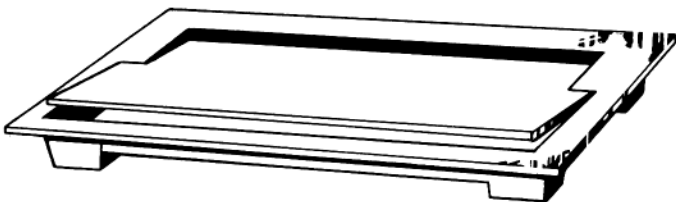

ASH DUMP:

Is a pivoted metal door located flush with the hearth surface through which ashes are dropped into the ashpit below. The ash dump is exposed to the heat from the fire. It is a known fact that cast iron has much more resistance to heat than steel. For permanence the ash dump should be made of cast iron.

VESTAL OFFERS CAST IRON AND STEEL ASH DUMPS OF VARIOUS SIZES.
OUTSIDE AIR MODELS ARE ALSO AVAILABLE.

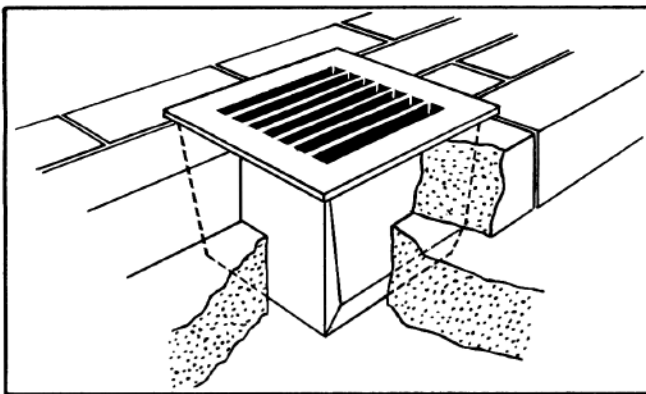

ASH CADDY:

In some homes design features do not permit the construction of an ashpit. This is especially true of homes designed on slab construction. If design does not permit an ash pit, the Vestal Ash Caddy can easily be installed in the fireplace hearth during construction. The Vestal Ash Caddy is a real convenience for removal of ashes. Simply sweep or shovel ashes through the top grating, of cast iron, into the galvanized pail below. To remove ashes, the grating is lifted aside and the pail is lifted out by the bail.

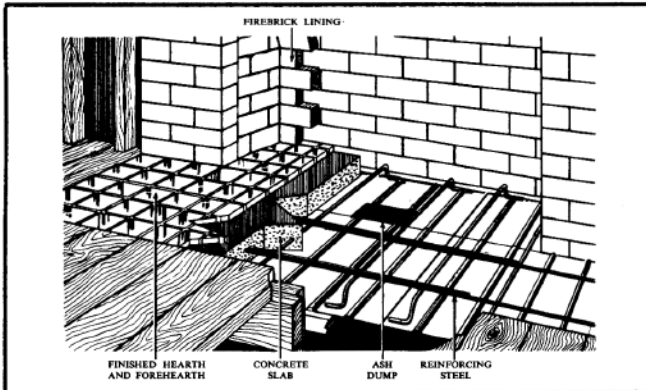

HEARTH:

Is the part of the fireplace on which the fire is laid. The fore-hearth is the area outside the fireplace opening. It is important that the hearth be wholly supported by the chimney, this prevents cracking in case unequal settlement occurs. The fore-hearth should be supported by the chimney but in many designs this is not practical. The usual practice is to pour a rough concrete slab, the soundest construction provides a continuous slab, to serve as base for both hearth and fore-hearth. The ash dump or the ash caddy is installed in the rough hearth slab at time of pouring the concrete. The finished hearth surface of brick, face tile, etc., is then applied over the rough base slab.

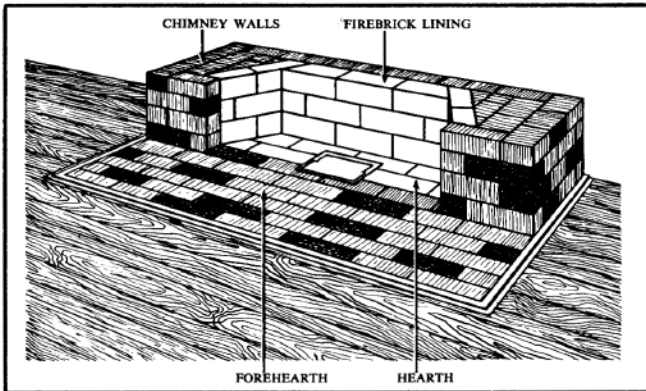

FIREBOX:

Is the chamber that contains the fire. For soundest construction the sides and back of the firebox are lined with one course of firebrick. Sides are splayed in, and back wall sloped to reflect a maximum of heat into the room. The splayed sides make the back of the fireplace narrower than the front opening, and gives the fireplace a reflector shape. This splay should be approximately 3 to 4 inches to the foot in depth. Curving the back of the firebox should be avoided. The best plan is to build the back wall plumb for three to five courses of brick and then start the back wall forward on an angle that will bring the fire brick back wall up under the entire rear flange of the throat damper.

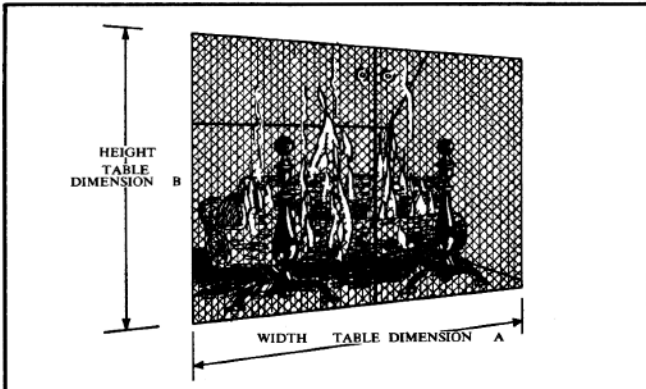

FIREPLACE OPENING:

Correct proportioning of the fireplace opening has a great deal to do with how well the fireplace will function. The size of the opening also determines the correct size flue lining to use. The total area of the fireplace opening is found by multiplying the finished open width by the finished open height (A x B). The result will be square inches. The generally accepted rule for a conventional fireplace (one side only open) is that the cross sectional area of the flue lining be 1/12 or greater the total area of the fireplace opening. For modern design fireplaces (two or more open sides) the cross section area of each open side must be calculated; and all open sides added together; the cross section area of the flue should be 1/10 or greater the total area of all open sides for this type fireplace. There are no arbitrary rules controlling the depth of the fireplace or the height of the opening. These two do have a relationship and should be correctly proportioned. In general the wider the opening the greater the depth and height. We suggest dimensions as outlined in table on the inside page. We do not maintain that these dimensions must be exactly followed; we offer this table as a convenient guide.

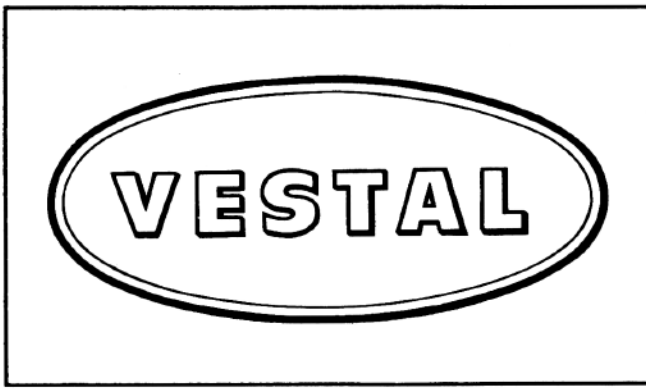

NOTE: If the fireplace is designed primarily to burn hardwood logs, some builders find it desirable to increase the front to back depth (dimension H) by 3 to 6 inches. This will permit the use of larger diameter logs as fuel.

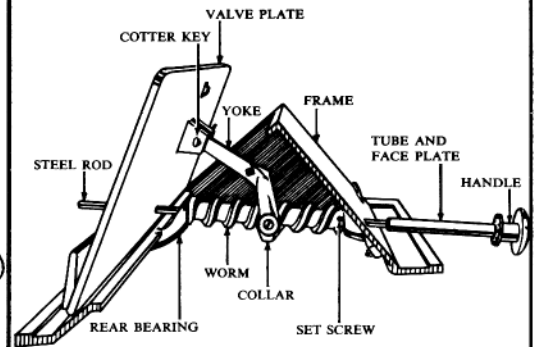
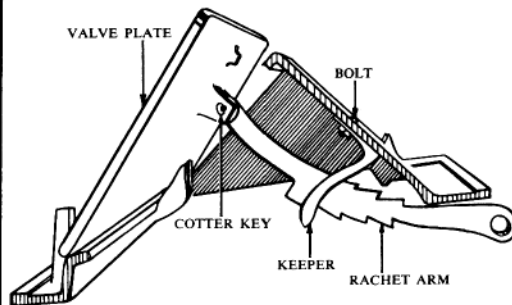
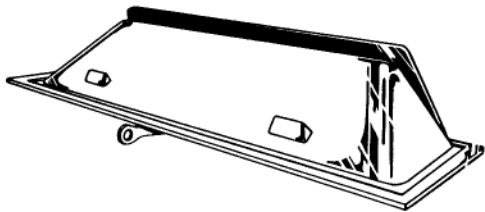

VESTAL FIREPLACE DAMPER

POKER CONTROL
(Ratchet Arm is Reversible)

ROTARY CONTROL
(Interchangeable with Poker Control)

ALL CONTROLS FOR VESTAL FIREPLACE DAMPERS, REGARDLESS OF THE TYPE CONTROL ARE SIMPLE, RUGGED, SMOOTH WORKING AND FOOLPROOF.

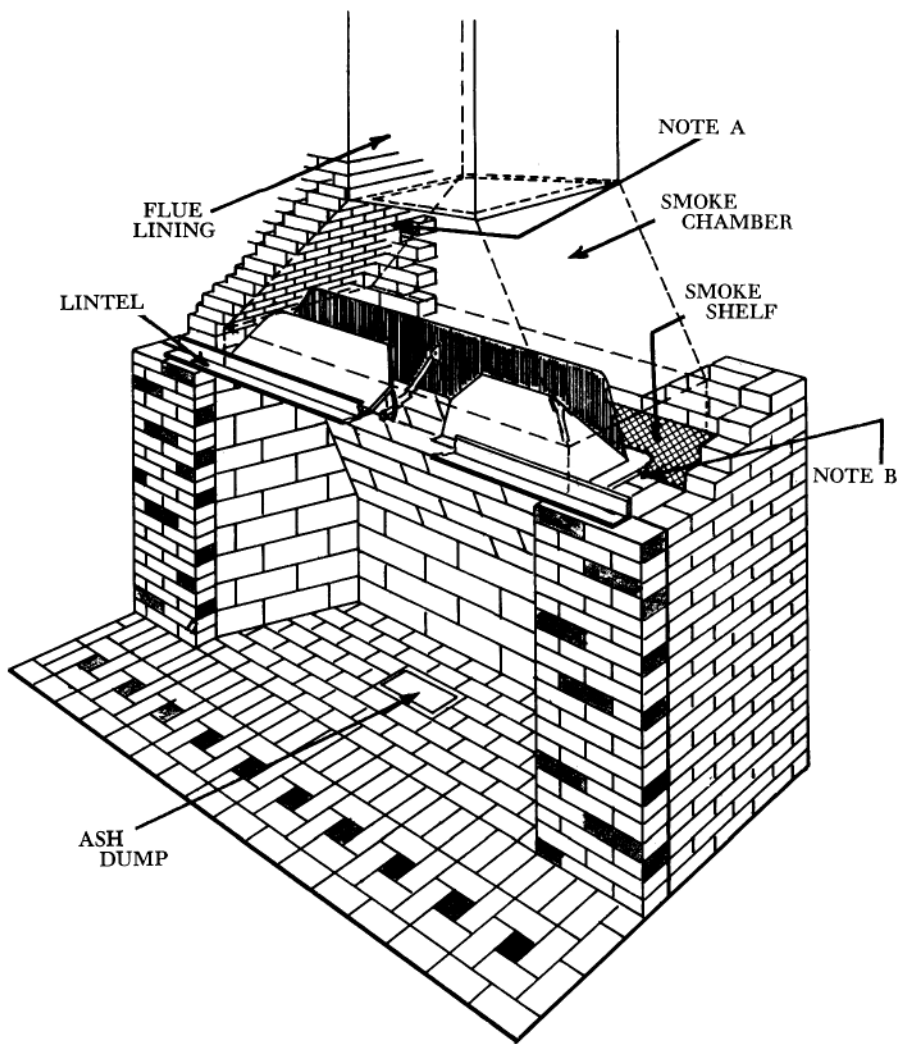

NOTE A:

The slope of both sides of the smoke chamber should be identical. The corbelled sides should be plastered smooth to present as little friction as possible to the rising smoke. Flue lining should be directly above the center line of the smoke chamber. Sometimes design does not permit running the flue lining directly vertical out the stack. In this event any necessary sloping should be done in the flue lining, and not in the smoke chamber. If design problems necessitate an unusual location of the flue the Vestal Multi-Opening Fireplace Damper can solve such knotty problems of location for the architect. Refer to details for Vestal Multi-Opening Damper.

NOTE B:

Do not fill the ends of the damper in solidly with masonry. Leave room for expansion from the heat.

FIREPLACE THROAT OR DAMPER:

The throat is the part of the fireplace just above the fireplace opening and serves to connect the firebox with the smoke chamber. Proper shaping of the throat is conceded the most critical part of the fireplace. A properly designed fireplace damper relieves the mason the responsibility of designing the important throat. Vestal Manufacturing Company has correctly designed a wide range of sizes and styles of fireplace dampers for this purpose.

The throat should be long and narrow to make the fire burn evenly across the back wall. The throat should have a large area of cross section and a high shape, and should have smooth side walls with as little friction as possible for smoke drawing up the chimney. Most masons today do not attempt to design the throat. They prefer to use a fireplace damper.

The damper also allows the draft to be shut off during non-use periods, conserving other sources of heat or air conditioning. It also permits regulation of the draft when the fireplace is in use. The fireplace damper should be designed for permanence. Once it is installed in the masonry it is difficult to replace. The damper is exposed to direct heat from the fire. Cast iron is more resistant to heat than steel. We recommend a cast iron damper for long lasting permanence.

The damper valve plate should be easily removed during construction, and when cleaning the accumulation of soot from the smoke shelf after long usage. The valve plate should close tightly. The operating mechanism should work smoothly and easily. Vestal Fireplace Dampers, either poker control, rotary control or chain control, meet the qualifications.

The back flange of the fireplace damper should be protected from intense heat by being placed directly over and fully supported by the back wall firebrick masonry. The fireplace damper should not be built in solidly at each end.

Leave a minimum of 1/4" clearance between both ends of fireplace damper and masonry to allow for expansion when heated.

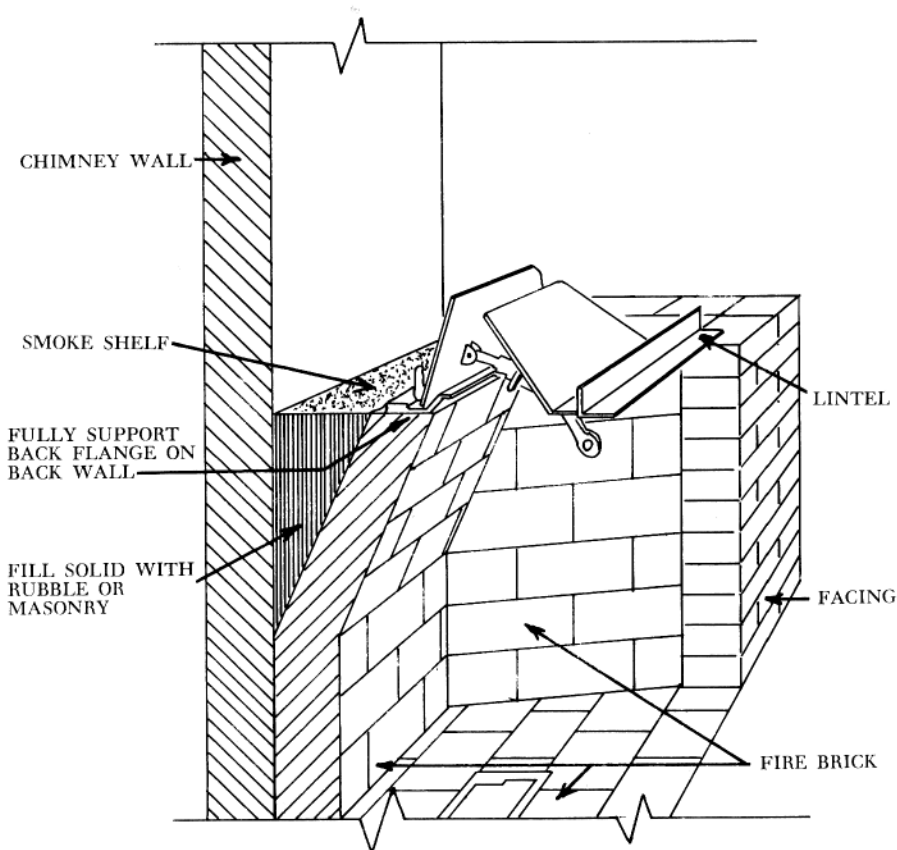

SMOKE SHELF:

The smoke shelf is made by extending the back wall firebrick lining forward until it meets the rear flange of the fireplace damper. The depth for the smoke shelf will vary, depending on the size of the flue lining and depth of the fireplace. Many fireplaces have been built by placing the flue lining directly over the fireplace damper and eliminating the smoke shelf. Experienced builders agree that the smoke shelf is an essential part of a fireplace. The smoke shelf helps to turn wind coming down the flue back up the stack. It helps to eliminate puffs of wind entering the fireplace and helps to keep accumulations of soot and ash from coming into the room. We recommend the incorporation of the smoke shelf in all fireplace construction.

SMOKE CHAMBER:

See above drawing. The smoke chamber extends from the level of the damper and smoke shelf up to the bottom of the clay flue lining. The enclosure narrows as it extends up to the flue lining. The slope of both sides must be identical and all walls should be trowelled smooth to present as little resistance as possible to the rising smoke.

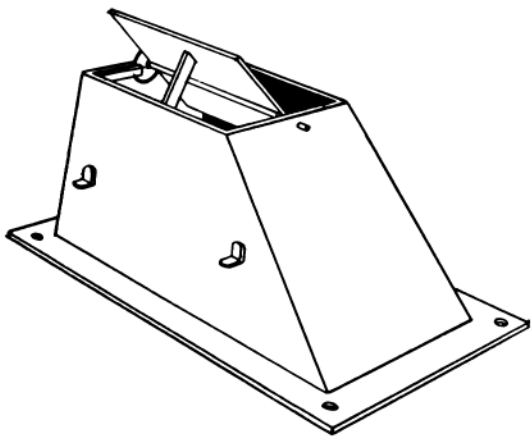

MODERN DESIGN FIREPLACES (More than one open side)

Today's trend toward modern design homes has created a desire for the unusual fireplace. The Vestal Multi-Opening Fireplace Damper is the solution to the problem of constructing a fireplace that has two or more open sides. Refer to Vestal Manufacturing Company's brochure of "Installation Instructions Multi-Opening Fireplace Dampers".

REMEMBER for successful fireplace design:

Each fireplace must have its own individual flue.

Give masonry time to cure before building a fire.

The chimney needs sufficient height to promote draft. The less the height the less the draft.

A chimney height of twenty feet or more is desirable.

Top of chimney should project three feet or more above the highest point of the roof.

Smoke free fireplaces require correct proportioning. The larger the fireplace opening the larger the flue.

Provide a cast iron damper, cast iron ash dump, and cast iron cleanout door for permanence.

Leave a minimum of 1/4" between damper and masonry for expansion and contraction of damper.

Modern insulation often makes the house so air tight that the fire does not have sufficient air for combustion. If so, the slight cracking of a window will solve this problem, or with the addition of an outside air source.

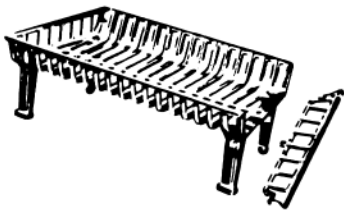

GRATE BASKET

Vestal Manufacturing Company also makes a wide selection of ash dumps, cleanout doors, grate baskets and other metal building products. Refer to our general catalog.

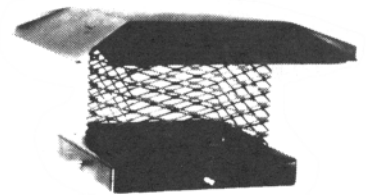

"TRI-MOUNT" CHIMNEY CAPS

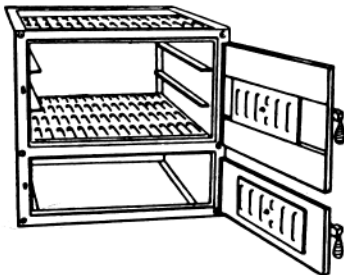

OUTDOOR FIREPLACE

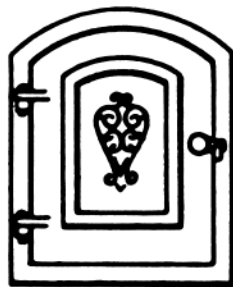

DOORS



LINTELS

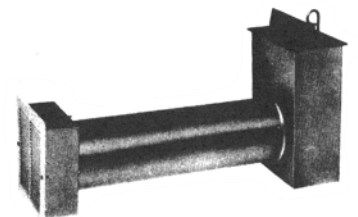

"OA" VESTAL OUTSIDE AIR KIT FOR NEW CONSTRUCTION - MASONRY FIREPLACES