

SENCO[®]

2019 CATALOG



MAKING HARD WORK EASIER



OVER 80% OF THE FASTENERS WE SELL ARE MANUFACTURED IN CINCINNATI

- Steel rod purchased from US manufacturers
- Rod drawn down to exact wire gauge sizes
- ICC Certified Facility
- Clean wire process
- Each box date stamped for Quality Assurance
- All precision forming dies made in house

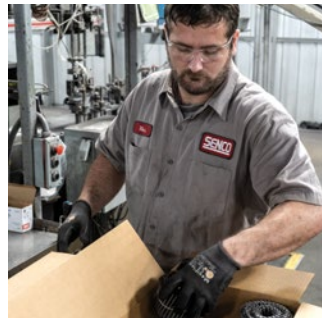

TABLE OF CONTENTS

See all tools at a glance in the foldout located on pages 88-90.



DuraSpin Auto-Feed Screw Systems

DS215-18V, DS212-18V, DS312-18V	3
DS235-AC, DS232-AC, DS332-AC	4
DS425AC, DS440AC	5
DS220, DS320	6
SG2510, SG4100	7
Collated Screws	8-11
Screw System Accessories	12-13



Fusion Cordless Nailers

F18, F16-S, F-15	15
Fasteners	16-17



Finish & Woodworking

FinishPro23SXP, FinishPro23LXP	19
FinishPro21LXP, LS1XP, FinishPro18Mg, FinishPro18BMg	20
SLP20XP, FinishPro25XP	21
FinishPro16XP	22
FinishPro30XP, FinishPro35Mg, FinishPro42XP	23
SLS20XP, SLS25XP, SKSXP	24
SLS150Mg, SLS18Mg, SC1XP Senclamp, SC2 Sencor	25
Fasteners	26-31



Framing, Sheathing & Subfloors

FramePro325XP, FramePro701XP, FramePro751XP	33
FramePro325FRHXP, FramePro702XP, FramePro752XP	34
SCN60XP, SCN65XP	35
JoistPro150XP, JoistPro250XP, Mini-Hand Nailer, A20 Hand Nailer	36
SCP40XP, PS15XP, PS20XP	37
SNS41, NS20XP, SQS55XP	38
Fasteners	39-47



Roofing, Siding & Fencing

RoofPro445XP, SCN49XP	49
PS15RXP, BC58, A11	50
Fasteners	51-53



Pallets & Crating

PalletPro57FXP, PalletPro100XP, PalletPro130XP	55
DFPXP, F75LXP, F75SXP	56
Fasteners	57-59



Upholstery & Furniture

SFT10XP Family	61
SFW09, NS20BXP	62
Fasteners	63-65



Flooring

SHF200, SLS20XP-HF	67
Fasteners	68



Air Compressors

PC1131, PC0968, PC1280, PC1010, PC1010N, PC0947	71
---	----



Accessories

Air Hoses	73
Plugs & Couplers, Swivel Plugs & Swivel Couplers	74
Air Hose & Compressor Accessories, Regulators & Gauges	75
Oils & Lubricants, Safety Glasses & Tool Belt Hooks	76
Battery & Charger Systems, No-Mar Pads	77
Parts Kits	78



Product Reference

Fastener Finish Types	79
Box, Carton & Pallet Quantities - Fasteners	80-81
Item Code Index	82-85
Fasteners at a Glance	86-87
Tools at a Glance	88-90

DURASPIN AUTO-FEED SCREW SYSTEMS

DESIGNED TO MAKE YOU MORE PRODUCTIVE

DuraSpin® systems increase screw fastening speeds by more than four times versus bulk screwdrivers and loose screws, improving job site productivity by more than 30%. Now we are leading the way to even greater productivity gains with our next generation of tools and fasteners.

APPLICATIONS

Whether you choose an integrated tool or use our full line of kits and accessories, you can customize DuraSpin auto-feed screw systems for a variety of applications including drywall, flooring, decking and industrial projects. Check out our ICC certified collated screws for steel frame construction.

FEATURES

- Patented corner-fit feed system for better screw placement in tight spaces and corners
- Locking depth-of-drive adjustment
- Tool-free adjustable nosepiece
- Easily load 50 screws in less than a second
- Trigger lock for continuous operation
- Long-lasting drive bits with quick-slide release



DS215-18V

2" CORDLESS 18V LI-ION 5000 RPM

ITEM #7W0001N



2 bits included



Features

- High-speed motor designed for drywall applications
- Patented feed system fits into corners
- EZ-Load feature for quick loading
- Includes 2 bits (as shown), drywall nosepiece FC0878, wood nosepiece FB0157, 2 batteries, charger and carrying bag

PRIMARY APPLICATIONS

Drywall to Wood, Drywall to Light Steel

SECONDARY APPLICATIONS

Cement Board, Underlayment

DS212-18V

2" CORDLESS 18V LI-ION 2500 RPM

ITEM #7X0001N



2 bits included



Features

- High-torque motor for driving into dense material
- Drives drill-point fasteners with variable-speed trigger
- Depth-of-drive lock ensures same countersink every time
- Includes 2 bits (as shown), drywall nosepiece FC0878, wood nosepiece FB0157, 2 batteries, charger and carrying bag

PRIMARY APPLICATIONS

Metal Framing, Cement Board

SECONDARY APPLICATIONS

Drywall to Wood, Drywall to Steel, Subfloor, Underlayment, Wood Decking, Sheathing to Steel

DS312-18V

3" CORDLESS 18V LI-ION 2500 RPM

ITEM #7Y0001N



2 bits included



Features

- Tool-free screw-length adjustment to set screw length quickly
- Load quickly and prevent misfeeds with patented screw strip guide
- Drive the complete range of Senco collated screws up to 3"
- Includes 2 bits (as shown), drywall nosepiece FC0895, wood nosepiece FB0159, 2 batteries, charger and carrying bag

PRIMARY APPLICATIONS

Wood Decking, Tile Roofing

SECONDARY APPLICATIONS

Drywall to Wood, Drywall to Steel, Subfloor, Metal Framing, Composite Decking, Cement Board, Sheathing to Steel

Product Reference Chart

TOOL SPECS	DS215-18V	DS212-18V	DS312-18V
Speed (RPM)	0-5000	0-2500	0-2500
Voltage	18V	18V	18V
Weight	5.3 lbs (2.4 kg)	5.3 lbs (2.4 kg)	6 lbs (2.7 kg)
Height	9.5" (241 mm)	9.5" (241 mm)	9.5" (241 mm)
Length	15" (381 mm)	15" (381 mm)	16.4" (417 mm)
Width	3.9" (99 mm)	3.9" (99 mm)	3.9" (99 mm)
Warranty	1 yr	1 yr	1 yr
FASTENER SPECS	Collated screws are located on pages 8-11.		
Range	1"-2"*	1"-2"*	1"-3"
Shank Diameter	#6 - #8	#6 - #10	#6 - #10
TOOL FEATURES			
Depth-of-Drive	Yes	Yes	Yes
Reversible Belt Hook	Yes	Yes	Yes
Trigger	Variable with Lock	Variable with Lock	Variable with Lock
Power Type	18V 1.5 Ah Compact Li-Ion	18V 1.5 Ah Compact Li-Ion	18V 1.5 Ah Compact Li-Ion
Reversible	Yes	Yes	Yes

All cordless screwdrivers come with (2) 18V Li-Ion batteries (VB0155), charger (VB0156), drywall nosepiece, wood nosepiece and storage bag.

*FC0822 nosepiece drives ½" to 2" screws.

DS235-AC

2" CORDED 5000 RPM

ITEM #7T0001N



2 bits included



Features

- High-speed motor designed for drywall applications
- Patented feed system fits into corners
- EZ-Load feature for quick loading
- Includes 2 bits (as shown), drywall nosepiece FC0878, wood nosepiece FB0157 and carrying bag

PRIMARY APPLICATIONS

Drywall to Wood, Drywall to Light Steel, Underlayment, Cement Board

SECONDARY APPLICATIONS

Subfloor, Wood Decking

DS232-AC

2" CORDED 2500 RPM

ITEM #7U0001N



2 bits included



Features

- High-torque motor for driving into dense material
- Drives drill-point fasteners with variable-speed trigger
- Depth-of-drive lock ensures same countersink every time
- Includes 2 bits (as shown), drywall nosepiece FC0878, wood nosepiece FB0157 and carrying bag

PRIMARY APPLICATIONS

Metal Framing, Cement Board

SECONDARY APPLICATIONS

Drywall to Wood, Drywall to Steel, Subfloor, Underlayment, Wood Decking, Composite Decking

DS332-AC

3" CORDED 2500 RPM

ITEM #7V0001N



2 bits included



Features

- Tool-free screw-length adjustment to set screw length quickly
- Load quickly and prevent misfeeds with patented screw strip guide
- Drive the complete range of Senco collated screws up to 3"
- Includes 2 bits (as shown), drywall nosepiece FC0895, wood nosepiece FB0159 and carrying bag

PRIMARY APPLICATIONS

Wood Decking, Composite Decking, Sheathing to Steel

SECONDARY APPLICATIONS

Drywall to Wood, Drywall to Steel, Subfloor, Underlayment, Metal Framing, Cement Board

Product Reference Chart

TOOL SPECS	DS235-AC	DS232-AC	DS332-AC
Speed (RPM)	0-5000	0-2500	0-2500
Current (Amps)	6.0	6.0	6.0
Voltage	120V/60Hz	120V/60Hz	120V/60Hz
Weight	5.7 lbs (2.6 kg)	5.8 lbs (2.6 kg)	5.9 lbs (2.7 kg)
Height	9.5" (241 mm)	9.5" (241 mm)	9.5" (241 mm)
Length	16.4" (417 mm)	16.4" (417 mm)	17.3" (439 mm)
Width	3.4" (86 mm)	3.4" (86 mm)	3.4" (86 mm)
Warranty	1 yr	1 yr	1 yr
FASTENER SPECS	Collated screws are located on pages 8-11.		
Range	1"-2"*	1"-2"*	1"-3"
Shank Diameter	#6 - #10	#6 - #12	#6 - #12
TOOL FEATURES			
Depth-of-Drive	Yes	Yes	Yes
Reversible Belt Hook	Yes	Yes	Yes
Trigger	Variable with Lock	Variable with Lock	Variable with Lock
Power Type	Corded	Corded	Corded
Reversible	Yes	Yes	Yes

All corded screwdrivers come with drywall nosepiece, wood nosepiece and storage bag. *FC0822 nosepiece drives 1/2" to 2" screws.

DS425AC

3" ATTACHMENT KIT WITH 2500 RPM SCREWDRIVER

ITEM #6W0012N



3 bits included



Features

- 3 Tools in 1, providing configurations for multiple applications
- High-torque motor powerful enough for any application
- EZ-Load feature for quick loading
- Prevent misfeeds with patented sliding rail system
- Includes SG2510 screwdriver, DS320 attachment, adaptor, 3 bits (as shown) and storage bag

PRIMARY APPLICATIONS

Wood and Composite Decking,
Cement Board, Sheathing to Steel

SECONDARY APPLICATIONS

Drywall to Wood, Drywall to Steel,
Subfloor, Underlayment, Metal
Framing

DS440AC

3" ATTACHMENT KIT WITH 4000 RPM SCREWDRIVER

ITEM #6W0011N



3 bits included



Features

- 3 Tools in 1, providing configurations for multiple applications
- High-speed motor designed for subfloor applications
- EZ-Load feature for quick loading
- Prevent misfeeds with patented sliding rail system
- Includes SG4100 screwdriver, DS320 attachment, adaptor, 3 bits (as shown) and storage bag

PRIMARY APPLICATIONS

Subfloor, Underlayment,
Wood Decking, Cement Board

SECONDARY APPLICATIONS

Drywall to Wood, Drywall to Steel

Product Reference Chart

TOOL SPECS	DS425AC	DS440AC
Speed (RPM)	0-2500	0-4000
Current (Amps)	6.5	6.5
Weight	7 lbs (3.2 kg)	6.8 lbs (3.1 kg)
Height	7.5" (191 mm)	7.5" (191 mm)
Length	20.5" (521 mm) 40" (1016 mm) w/ext. pole	20.5" (521 mm) 39.5" (1003 mm) w/ext. pole
Width	2.5" (64 mm)	2.5" (64 mm)
Warranty	1 yr	1 yr
FASTENER SPECS	Collated screws are located on pages 8-11.	
Range	1"-3"	1"-3"
Shank Diameter	#6 - #12	#6 - #12
TOOL FEATURES		
Depth-of-Drive	Yes	Yes
Belt Hook	Yes	Yes
Trigger	Variable with lock	Variable with lock
Power Type	Corded	Corded
Reversible	Yes	Yes

3 Tools in 1

Quickly and easily convert your DS425AC or DS440AC auto-feed attachment kit into 3 tools for multiple applications.



1. Use the screwdriver to drive loose screws.

2. Use the attachment for multiple auto-feed applications.



3. Add the extension pole for stand-up applications like subfloor and decking.

DS220

2" AUTO-FEED SCREWDRIVER ATTACHMENT

ITEM #6W0001N



Features

- Prevent misfeeds with patented sliding rail system
- Depth-of-drive lock ensures same countersink every time
- Attaches to your screwdriver with our full line of adapters (sold separately)
- Includes 2" attachment, drywall nosepiece FC0878 and wood nosepiece FB0157

PRIMARY APPLICATIONS

Drywall to Wood, Drywall to Steel, Metal Framing, Cement Board, Sheathing to Steel

SECONDARY APPLICATIONS

Subfloor, Underlayment, Wood Decking, Composite Decking

Bits and adapters sold separately

DS320

3" AUTO-FEED SCREWDRIVER ATTACHMENT

ITEM #6W0003N



Features

- Prevent misfeeds with patented sliding rail system
- Perfect for stand-up applications using extension pole and adjustable handle
- Attaches to your screwdriver with our full line of adapters (sold separately)
- Includes 3" attachment, extension pole, adjustable handle, drywall nosepiece FC0895 and wood nosepiece FB0159

PRIMARY APPLICATIONS

Subfloor, Underlayment, Wood Decking, Composite Decking, Cement Board, Sheathing to Steel

SECONDARY APPLICATIONS

Drywall to Wood, Drywall to Steel, Metal Framing

Bits and adapters sold separately

Product Reference Chart

TOOL SPECS	DS220	DS320
Weight	1.5 lbs (.68 kg)	3.3 lbs (1.5 kg)
Height	3.3" (84 mm)	3.3" (84 mm)
Length	21" (533 mm)	21" (533 mm)
Width	2.5" (64 mm)	2.5" (64 mm)
Warranty	1 yr	1 yr
FASTENER SPECS	Collated screws are located on pages 8-11.	
Range	1"-2"*	1"-3"
Shank Diameter	#6 - #12	#6 - #12
TOOL FEATURES		
Depth-of-Drive	Yes	Yes

Additional screwdrivers, bits and adaptors sold separately — see page 12
 *FC0822 nosepiece drives 1/2" to 2" screws.

Adapters for over 15 screwdriver motors

including DeWALT®, Makita®, and SENCO.



SG2510

HIGH-PERFORMANCE 2500 RPM SCREWDRIVER

ITEM #6X0002N



2 bits included



Features

- High-torque motor for driving into dense materials
- Industrial-grade metal gear housing designed to sustain heavy usage
- Great for all-day use with ergonomic, lightweight and compact design
- Trigger lock for continuous operation
- Industrial-grade 10' cord
- Includes 2 bits (as shown)

PRIMARY APPLICATIONS

Composite Decking,
Wood Decking, Cement Board,
Sheathing to Steel, Metal Framing

SECONDARY APPLICATIONS

Drywall to Wood, Drywall to Steel,
Subfloor, Underlayment

SG4100

HIGH-PERFORMANCE 4000 RPM SCREWDRIVER

ITEM #6X0004N



2 bits included



Features

- High-speed motor designed for drywall applications
- Industrial-grade metal gear housing designed to sustain heavy usage
- Great for all-day use with ergonomic, lightweight and compact design
- Trigger lock for continuous operation
- Industrial-grade 10' cord
- Includes 2 bits (as shown)

PRIMARY APPLICATIONS

Drywall to Wood, Drywall to Steel,
Subfloor, Underlayment,
Cement Board

SECONDARY APPLICATIONS

Wood Decking

Nosepieces and drive bits for every application:

drywall, wood, metal and metal channel.







Product Reference Chart

TOOL SPECS	SG4100	SG2510
Speed (RPM)	0-4000	0-2500
Current (Amps)	6.5	6.5
Weight	3.4 lbs (1.5 kg)	3.6 lbs (1.6 kg)
Height	7.5" (191 mm)	7.5" (191 mm)
Length	12" (305 mm)	12.5" (318 mm)
Width	2.5" (64 mm)	2.5" (64 mm)
Warranty	1 yr	1 yr
TOOL FEATURES		
Depth-of-Drive	Yes	Yes
Belt Hook	Yes	Yes
Trigger	Variable with Lock	Variable with Lock
Power Type	Corded	Corded
Reversible	Yes	Yes

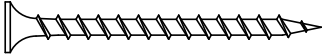
Drywall to Wood Screws



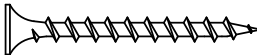

Sharp point drywall screws for fastening interior drywall to wood

Finish: Gray Phosphate				
		 #2 Phillips	 Bugle	 Sharp
Gauge	Length	Thread	Quantity	Item Code
6	1¼"	Coarse	1000 Tub	06A125P
6	1¼"	Coarse	4000 Box	06A125PB
6	1½"	Coarse	1000 Tub	06A162P
6	1½"	Coarse	4000 Box	06A162PB
7	2"	Coarse	1000 Tub	07A200P
8	2½"	Coarse	1000 Box	08A250PK

Finish: Exterior				
Gauge	Length	Thread	Quantity	Item Code
6	1½"	Coarse	1000 Tub	06A162W

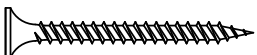



Drywall to Light Steel Screws

Sharp point, double thread drywall screws for fastening interior drywall to light-gauge metal studs



Finish: Gray Phosphate					
		 #2 Phillips	 Bugle	 Sharp	
Gauge	Length	Thread	Quantity	Item Code	
6	1¼"	Double Thread	1000 Tub	06B125P*	
6	1¼"	Double Thread	4000 Box	06B125PB*	
6	1½"	Double Thread	1000 Tub	06B162P*	
6	1½"	Double Thread	4000 Box	06B162PB*	

Gypsum to Heavy Steel Screws

Drywall screws with self-drilling point for fastening drywall or gypsum sheathing to heavy-gauge metal studs

Finish: Clear Zinc					
		 #2 Phillips	 Bugle	 Drill	
Gauge	Length	Thread	Quantity	Item Code	
6	1¼"	Fine	4000 Box	06C125CB*	
6	1½"	Fine	4000 Box	06C162CB*	
6	2"	Fine	4000 Box	06C200CB*	

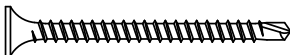
Finish: Exterior				
Gauge	Length	Thread	Quantity	Item Code
6	1¼"	Fine	1000 Box	06C125WK*
6	1½"	Fine	1000 Box	06C162WK*
8	3"	½ Fine	1000 Box	08C300WK





Finish: Gray Phosphate					
Gauge	Length	Thread	Quantity	Item Code	
6	1¼"	Fine	4000 Box	06C125PB*	
6	1½"	Fine	4000 Box	06C162PB*	
6	2"	Fine	4000 Box	06C200PB*	





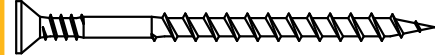



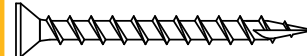

*ICC certified test data available on all highlighted items. Refer to ESR-3558 for details.

Wood to Wood Screws





General purpose interior wood screws

Finish: Yellow Zinc				
		 #2 Square	 Flat	 Sharp
Gauge	Length	Thread	Quantity	Item Code
8	1½"	Coarse	1000 Tub	08F150Y
8	1¾"	¾ Coarse	1000 Tub	08F175Y
8	2"	¾ Coarse	1000 Tub	08F200Y
8	2½"	¾ Coarse	800 Tub	08F250Y
8	3"	¾ Coarse	800 Tub	08F300Y





Finish: Yellow Zinc				
		 #2 Square	 Flat	 Type 17
Gauge	Length	Thread	Quantity	Item Code
8	1¾"	Coarse	4000 Box	08L175YB

Finish: Clear Zinc				
		 #2 Square	 Flat Head + Nibs	 Type 17
Gauge	Length	Thread	Quantity	Item Code
8	1¾"	Coarse	4000 Box	08L125CBLCTS

Interior wood screws for harder-engineered lumber and flooring materials

Finish: Yellow Zinc				
		 #2 Square	 Trim Head + Nibs	 Sharp
Gauge	Length	Thread	Quantity	Item Code
8	2"	High Low	4000 Box	08F200YBTHSS

General purpose interior wood screws and subfloors

Finish: Yellow Zinc				
		 Rex	 Flat	 Sharp
Gauge	Length	Thread	Quantity	Item Code
8	1¾"	2/3 Double	1000 Box	08F175YKX

08F175YKX

Double Thread, Interior Wood Screw

FEATURES AND BENEFITS



- Double thread design reduces installation time while improving holding power
- Our Rex drive provides smooth engagement with high torque transmitting capability
- Flathead provides strong holding power

COLLATED SCREWS

Wood to Heavy Steel Screws

Pilot point screws for fastening sheathing to heavy steel



Finish: Clear Zinc 

 #2 Square  Flat  Pilot

Gauge	Length	Thread	Quantity	Item Code
8	2"	Fine	1000 Box	08G200CKLFPS

Wing drill point screws for fastening sheathing to heavy steel

Finish: Clear Zinc 

 #2 Square  Wafer + Nibs  Wing Drill

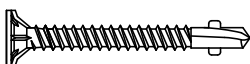

Gauge	Length	Thread	Quantity	Item Code
8	1 1/2"	Fine	1000 Tub	08G162CTWFWS
10	1 1/2"	Fine	1000 Tub	10G162CTWFWS

Finish: Exterior 

Gauge	Length	Thread	Quantity	Item Code
#8	2"	Fine	1000 Tub	08G200WTWFWS
#8	2 1/2"	Fine	1000 Tub	08G250WWK

Low profile screw head for fastening sheathing to steel



Finish: Clear Zinc 

 #2 Square  Wafer  Drill

Gauge	Length	Thread	Quantity	Item Code
8	1"	Fine	4000 Box	08G100CBWFDS
10	1 1/2"	Fine	4000 Box	10G125CBWFDS

Wing drill point screws for fastening sheathing to heavy steel structures



Finish: Yellow Zinc 

 Rex  Flat  Wing T3 Drill

Gauge	Length	Thread	Quantity	Item Code
12	1 3/4"	Fine	1000 Box	12G175YKLFAX

Wing drill point screws for fastening sheathing to heavy steel structures

Finish: Yellow Zinc 



 Rex  Flat  Wing T5 Drill

Gauge	Length	Thread	Quantity	Item Code
12	2"	Fine	1000 Box	12G200YKLF CX
12	2 1/2"	Fine	1000 Box	12G250YKLF CX

Wood to Light Steel Screws

Sharp point screws for fastening sheathing to light steel

Finish: Clear Zinc 



 #2 Square  Flat  Sharp

Gauge	Length	Thread	Quantity	Item Code
8	1 1/2"	Double	1000 Tub	08G150CTL DSS

Cement Board Screws

Screws for fastening cement board or Hardie® board to wood



Finish: Exterior 

 #2 Square  Wafer + Nibs  Spoon

Gauge	Length	Thread	Quantity	Item Code
8	1 1/2"	High Low	1000 Tub	08T125W
8	2"	High Low	1000 Tub	08T200W

Screws for fastening cement board or Hardie® board to steel studs

Finish: Exterior 



 #2 Square  Wafer + Nibs  Drill

Gauge	Length	Thread	Quantity	Item Code
8	1 1/2"	Fine	4000 Box	08T150WBW FDS

Decking and Dock Screws

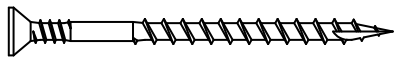
Exterior wood screws for projects such as decks, tile roofing, fencing, siding and docks

Finish: Exterior 

 #2 Square  Flat  Type 17

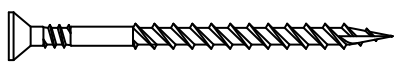

Gauge	Length	Thread	Quantity	Item Code
8	1 1/4"	3/8 Coarse	1000 Tub	08D175W
8	2"	3/8 Coarse	1000 Tub	08D200W**
8	2 1/2"	3/8 Coarse	800 Tub	08D250W**
8	2 1/2"	3/8 Coarse	1000 Box	08D250WK**
8	3"	3/8 Coarse	800 Tub	08D300W**

Finish: Stainless 304 

Gauge	Length	Thread	Quantity	Item Code
8	2 1/2"	3/8 Coarse	800 Tub	08D250S**
9	3"	3/8 Coarse	800 Tub	09D300S**

Underlayment Wood to Wood Screws

Finish: Gray Phosphate 

 #2 Phillips  Trim Head + Nibs  Sharp

Gauge	Length	Thread	Quantity	Item Code
7	1"	High Low	4000 Box	07Q100PB
7	1 1/4"	High Low	4000 Box	07Q125PB

Gray Phosphate #2 Square





7	1 1/4"	High Low	4000 Box	07Q125PBQ
---	--------	----------	----------	-----------

MIAMI-DADE COUNTY APPROVED  ICC certified test data available on all red highlighted items. Refer to ESR-3558 for details.

** Approved for use in Miami-Dade County FL.

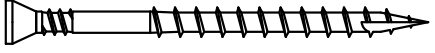

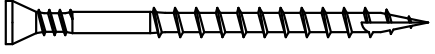

Composite Decking Screws

Trim head screws for fastening composite decking to wood

Finish: Exterior				
				
 #2 Square  Trim  Type 17				
Gauge	Length	Thread	Quantity	Item Code
8	2½"	¾ Coarse	800 Tub	08R250W
8	3"	¾ Coarse	800 Tub	08R300W

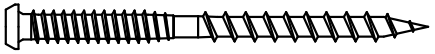
Finish: Stainless 304				
				
Gauge	Length	Thread	Quantity	Item Code
8	2½"	¾ Coarse	800 Tub	08R250S

Specially designed cup head screws eliminate mushrooming around screw head after installation



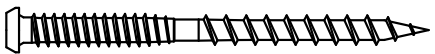

Finish: Exterior/Gray				
				
 #2 Square  Cupped Pan  Sharp				
Gauge	Length	Thread	Quantity	Item Code
8	2½"	Multi-Thread	800 Tub	08S250W003





Finish: Exterior/Tan				
				
Gauge	Length	Thread	Quantity	Item Code
8	2½"	Multi-Thread	800 Tub	08S250W592





Finish: Exterior/Brown				
				
Gauge	Length	Thread	Quantity	Item Code
8	2½"	Multi-Thread	800 Tub	08S250W497





Metal to Metal Screws





General purpose screws for fastening metal to metal

Finish: Clear Zinc				
				
 #2 Square  Modified Flat Pan  Drill				
Gauge	Length	Thread	Quantity	Item Code
10	¾"	Fine	1000 Tub	10M075CTMFDS*
10	1"	Fine	1000 Box	10M100CKMFDS*

Finish: Yellow Zinc				
				
 Rex  Flat Pan  Drill				
Gauge	Length	Thread	Quantity	Item Code
10	¾"	Fine	1000 Tub	10M075YTFDFX*

Finish: Yellow Zinc				
				
 Rex  Flat Pan  T4 Drill				
Gauge	Length	Thread	Quantity	Item Code
10	¾"	22 TPI	8000 Loose	10M075YLF4X*
10	¾"	22 TPI	1000 Box	10M075YKFT4X*

Finish: Yellow Zinc				
				
 Rex  Flat Pan  T4 Drill				
Gauge	Length	Thread	Quantity	Item Code
12	¾"	Fine	1000 Box	12M087YKFF4X*











Finish: Yellow Zinc				
				
 Rex  Flat Pan  T3 Drill				
Gauge	Length	Thread	Quantity	Item Code
12	1"	Fine	1000 Box	12M100YKFF3X*



*ICC certified test data available on all highlighted items. Refer to ESR-3558 for details.

COLLATED SCREWS

Light Metal Framing Screws











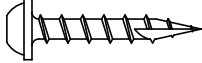



Self tapping metal framing screw				
Finish: Clear Zinc		 		
		 #2 Phillips	 Mod Truss	 Sharp
Gauge	Length	Thread	Quantity	Item Code
8	1/2"	Fine	1000 Tub	08M050CTRFSP*
Self drilling and tapping metal framing screws				
Finish: Clear Zinc		 		
		 #2 Phillips	 Mod Truss	 Drill
Gauge	Length	Thread	Quantity	Item Code
8	1/2"	Fine	1000 Tub	08M050CTRFDP*
10	3/4"	22 TPI	1000 Box	10M075CDK

New! 10M075CDK 22 TPI Metal Framing Screw

FEATURES AND BENEFITS

- Low profile head to reduce drywall flexing
- Higher thread count for better fastener engagement

Specialty Screws

General purpose screws for a range of applications including window installation and crating				
Finish: Clear Zinc		 		
		 #2 Square	 Round Washer	 Type 17
Gauge	Length	Thread	Quantity	Item Code
8	1 1/4"	Coarse	4000 Box	08X125CBACTS
Finish: Clear Zinc		 		
		 #2 Square	 Round Washer	 Drill
Gauge	Length	Thread	Quantity	Item Code
8	1 1/4"	Double	1000 Box	08X125CKADD5*
8	2"	Double	1000 Box	08X200CKADD5*
Finish: Clear Zinc		 		
		 #2 Square	 Pan Framing	 Sharp
Gauge	Length	Thread	Quantity	Item Code
8	1"	Double	4000 BOX	08M100CBPDSS

The New Standard in Professional Auto-Feed Screw Systems

INCREASE JOB SITE PRODUCTIVITY BY 30%!

4X faster than corded screwdrivers with loose screws*

- DuraSpin Auto-Feed Screw Systems eliminate the need to reach for fasteners and position them on a magnetic screw tip.
- DuraSpin allows for one-handed screw fastening with either hand, freeing the other hand to steady your work.

*DuraSpin Screw Fastening System Time & Motion Study. July, 2001. R.S.MEANS. CONSULTING SERVICES.



SCREW SYSTEM ACCESSORIES

Bits

Integrated auto-feed screw systems — 2 bits per pack			
Bits Fit	⊕ ITEM #	◻ ITEM #	⊛ ITEM #
DS212-18V DS215-18V DS232-AC DS235-AC	EA0297	EA0298	EA0299
DS312-18V DS332-AC	EA0300	EA0301	EA0302
Auto-feed attachment kits — 2 bits per pack			
Bits Fit	⊕ ITEM #	◻ ITEM #	⊛ ITEM #
DS325AC DS340AC	-	EA0272	-
DS425AC DS440AC	EA0314	EA0315	EA0316



Bits

Screwdriver and attachment combinations — 2 bits per pack			
Bits Fit	⊕ ITEM #	◻ ITEM #	⊛ ITEM #
SENCO SG2510 and SENC0 SG4100			
+ DS220	EA0311	EA0312	EA0313
+ DS320	EA0314	EA0315	EA0316
Makita with adapters ADP019 and MB0174			
+ DS220	EA0311	EA0312	EA0313
+ DS320	EA0314	EA0315	EA0316
DeWalt, Makita with adapter ADP020			
+ DS220	EA0317	EA0318	EA0319
+ DS320	EA0320	EA0321	EA0322

Bits-High Torque

25 count packaging for the high torque professional user*			
Bits Fit	⊕ ITEM #	◻ ITEM #	⊛ ITEM #
DS212-18V DS215-18V DS232-AC DS235-AC	EA0297N	EA0298N	EA0299N
DS312-18V DS332-AC	-	EA0301N	-
DS220	-	-	EA0313N
DS320	-	EA0315N	EA0316N



*High output impact feature is designed to extend bit life in metal applications

Adapters

For attaching screwdrivers to attachments			
Screwdriver	Fits Tools		Adapter ITEM #
SENCO	SG2510	SG4100	MB0173
DeWalt	DW252 DW253 DW255 DW257	DW266 DW272 DW276	ADP009
MAKITA	FS2200 FS2500	FS4200 FS6200	ADP019
	FS2701	-	MB0174
	6805BV	6827	ADP020



Bit Tips

Loose screwdriver — 10 bits per pack	
Bits Fit	⊛ ITEM #
SG2510 SG4100	EA0308



SCREW SYSTEM ACCESSORIES

Nosepieces

For wood applications			For drywall applications			For metal framing applications		
Fits Tools	Range	ITEM #	Fits Tools	Range	ITEM #	Fits Tools	Range	ITEM #
DS212-18V DS215-18V DS220 DS232-AC DS235-AC	1"-2"	FB0157	DS212-18V DS215-18V DS220 DS232-AC DS235-AC	1"-2"	FC0878	DS212-18V DS215-18V DS220 DS232-AC DS235-AC	½"-1"	FB0155
DS312-18V DS320 DS332-AC DS425AC DS440AC	1"-3"	FB0159	DS312-18V DS320 DS332-AC DS425AC DS440AC	1"-3"	FC0895	DS212-18V DS215-18V DS220 DS232-AC DS235-AC	½"-2"	FC0822
						DS312-18V DS320 DS332-AC DS425AC DS440AC	½"-3"	FC0887

Rubber & Sand Paper Replacement Pads

ITEM #	Description	Quantity	Fits Nosepiece
FC0983	Round no-mar pad with adhesive	3	FC0822, FC0887
FA0334	Square non-skid pad with adhesive	3	FA0211, FB0157, FB0159



Battery Systems

Compatible with all 18V Li-Ion DuraSpin and SENCO FUSION tools	
18V Li-Ion Battery 1.5 amp hour	Fits
VB0155	DS212-18V DS215-18V DS312-18V DS215-XP All Fusion Models <ul style="list-style-type: none"> • 1.5 amp hour • High-quality reliable cells • Longer storage life • Charges to 80% in 15 minutes
18V Li-Ion Battery 3.0 amp hour	Fits
VB0161	DS212-18V DS215-18V DS312-18V DS215-XP All Fusion Models <ul style="list-style-type: none"> • 3.0 amp hour • High-quality reliable cells • Longer storage life • Drives up to 2X as many fasteners as VB0155

Charger System

Can be used interchangeably with SENCO VB0155 and VB0161 batteries	
Battery Charger	For use with
VB0156	VB0155 VB0161 <ul style="list-style-type: none"> • Battery charge indicators display charge status of your battery • Compatible with all SENCO 18V Li-Ion batteries

FUSION CORDLESS NAILERS

CORDLESS PNEUMATIC PERFORMANCE. TRIM ALL DAY.

Experience award-winning cordless convenience in an all-day, everyday trim tool. Available in 15, 16 and 18 gauge, Fusion tools from SENCO feature a revolutionary cordless air-power technology.

- Instant shot with no ramp-up time
- No hose, compressor or fuel cell
- Drives like a pneumatic
- For professional finish and trim

In a recent industry-wide test, the Fusion F-15 was named the top cordless nail gun, highlighting its rapid rate of fire, consistent nail-driving performance in any material and its lightweight, slim-handle design.

APPLICATIONS

Finish and trim, fine woodworking, cabinet, furniture, decorative trim

FEATURES

- Rugged aluminum magazine
- Selectable drive switch allows for contact or sequential trigger actuation
- Nose-mounted LED light
- Adjustable belt hook
- Thumbwheel depth-of-drive
- EZ-Clear feature for quickly clearing jams
- Includes storage bag and charger



F-18

2 1/8" CORDLESS STRAIGHT BRAD NAILER

ITEM #6E0001N

18^{GA}



Features

- Thumbwheel depth-of-drive
- Nose-mounted LED light
- Rapid-charge battery reaches 80% in just 15 minutes

F-16S

2 1/2" CORDLESS STRAIGHT FINISH NAILER

ITEM #6U0001N

16^{GA}



Features

- Thumbwheel depth-of-drive
- Nose-mounted LED light
- Rapid-charge battery reaches 80% in just 15 minutes

F-15

2 1/2" CORDLESS ANGLED FINISH NAILER

ITEM #5N0001N

15^{GA}
34°



Features

- Thumbwheel depth-of-drive
- Nose-mounted LED light
- Rapid-charge battery reaches 80% in just 15 minutes

One Common Battery Platform

SENCO'S 18-Volt Li-Ion Battery System

Designed for long running times with quick recharges, the battery operates at full speed until depleted, so there is no gradual drop in power during use. Special LED fuel gauge displays battery life at the touch of a button.

18V Li-Ion Battery 1.5 amp hour	Fits
VB0155	F-18 F-16S F-15
18V Li-Ion Battery 3.0 amp hour	Fits
VB0161	F-18 F-16S F-15
Battery Charger	For use with
VB0156	VB0155 VB0161



SENCO's 18-Volt Li-Ion batteries work for all Fusion Finish Nailers and all Cordless Duraspin Auto-Feed Screw Systems. See the complete Senco Battery Platform in the accessories section on page 77.



Works with DS215-18V, DS215-XP, DS212-18V and DS312-18V models.

Product Reference Chart

TOOL SPECS	F-18	F-16S	F-15
Weight	6 lbs (2.72 kg)	6 lbs (2.72 kg)	6.2 lbs (2.81 kg)
Height	13" (330 mm)	13" (330 mm)	13" (330 mm)
Length	11" (276 mm)	11" (276 mm)	13" (330 mm)
Width	3" (76 mm)	3" (76 mm)	3" (76 mm)
Charge Time	80% in 15 minutes, 100% in 45 minutes.		
Warranty	2 yrs	2 yrs	2 yrs
FASTENER SPECS	Fasteners are located on pages 16-17		
Gauge	18	16	15
Range	5/8"-2/8"	3/4"-2 1/2"	1 1/4"-2 1/2"
Capacity	110	110	110
Angle/Collation	Straight Glued Strip	Straight Glued Strip	34° Angled Taped Strip
Series	AY, AX	M0	DA
TOOL FEATURES			
Patented Instant Shot Design	Yes	Yes	Yes
Depth-of-Drive	Yes, Tool-Free	Yes, Tool-Free	Yes, Tool-Free
EZ-Clear Jam Clearing	Yes	Yes	Yes
Trigger Actuation	Sequential or Contact	Sequential or Contact	Sequential or Contact
Aluminum Drive Cylinder	Yes	Yes	Yes
Belt Hook	Adjustable and Reversible	Adjustable and Reversible	Adjustable and Reversible

FUSION CORDLESS FASTENERS

18^{GA} Slight Head Brad Nails

Cabinets, decorative trim, picture frames and molding							
Length	Point	Head	Finish	Coating	Collation	Box Count	Item Code
5/8"	Chisel	Slight	Galv	Plain	Straight Glued Strip	5M	AY10EAA
3/4"	Chisel	Slight	Galv	Plain	Straight Glued Strip	5M	AY11EAA
1"	Chisel	Slight	Galv	Plain	Straight Glued Strip	5M	AY13EAA

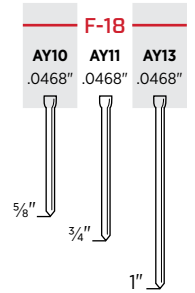

18^{GA} Straight Strip Brad Nails

Cabinets, decorative trim, picture frames and molding							
Length	Point	Head	Finish	Coating	Collation	Box Count	Item Code
5/8"	Chisel	Medium	Galv	Plain	Straight Glued Strip	5M	AX10EAA
3/4"	Chisel	Medium	Galv	Plain	Straight Glued Strip	5M	AX11EAA
1"	Chisel	Medium	Galv	Plain	Straight Glued Strip	5M	AX13EAA
1 1/4"	Chisel	Medium	Galv	Plain	Straight Glued Strip	5M	AX15EAA
1 1/2"	Chisel	Medium	Galv	Plain	Straight Glued Strip	5M	AX17EAA
1 5/8"	Chisel	Medium	Galv	Plain	Straight Glued Strip	5M	AX18EAA
1 3/4"	Chisel	Medium	Galv	Plain	Straight Glued Strip	5M	AX19EAA
2"	Chisel	Medium	Galv	Plain	Straight Glued Strip	5M	AX21EAA
2 1/2"	Chisel	Medium	Galv	Plain	Straight Glued Strip	5M	AX22EAA
1"	Chisel	Medium	Galv	Plain	Straight Glued Strip	1M (CS)	A201009
1 1/4"	Chisel	Medium	Galv	Plain	Straight Glued Strip	1M (CS)	A201259
1 1/2"	Chisel	Medium	Galv	Plain	Straight Glued Strip	0.8M (CS)	A201509
2"	Chisel	Medium	Galv	Plain	Straight Glued Strip	0.8M (CS)	A202009
5/8-1 1/4"	Chisel	Medium	Galv	Plain	Straight Glued Strip	1.2M (CS)	A209809*
1-2"	Chisel	Medium	Galv	Plain	Straight Glued Strip	1.2M (CS)	A209909*

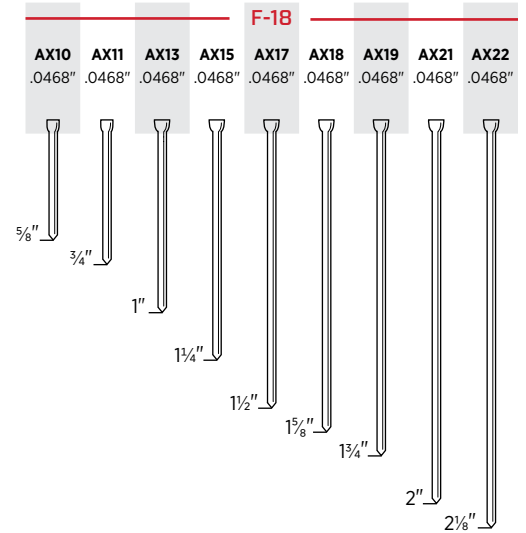

CS-Clamshell, *Variety Pack

16^{GA} Straight Strip Finish Nails

Furniture and cabinets, molding and trim, baseboard, chair rails, window casings and upholstery trim panels							
Length	Point	Head	Finish	Coating	Collation	Box Count	Item Code
3/4"	Chisel	T-head	Galv	Plain	Straight Glued Strip	2M	M001000
1"	Chisel	T-head	Galv	Plain	Straight Glued Strip	2M (PT)	M001001
1 1/4"	Chisel	T-head	Galv	Plain	Straight Glued Strip	2M (PT)	M001002
1 1/2"	Chisel	T-head	Galv	Plain	Straight Glued Strip	2M (PT)	M001003
1 3/4"	Chisel	T-head	Galv	Plain	Straight Glued Strip	2M (PT)	M001004
2"	Chisel	T-head	Galv	Plain	Straight Glued Strip	2M (PT)	M001005
2 1/2"	Chisel	T-head	Galv	Plain	Straight Glued Strip	2M (PT)	M001007
1 1/2"	Chisel	T-head	Galv	Plain	Straight Glued Strip	0.7M (CS)	A401509
2"	Chisel	T-head	Galv	Plain	Straight Glued Strip	0.7M (CS)	A402009
2 1/2"	Chisel	T-head	Galv	Plain	Straight Glued Strip	0.7M (CS)	A402509

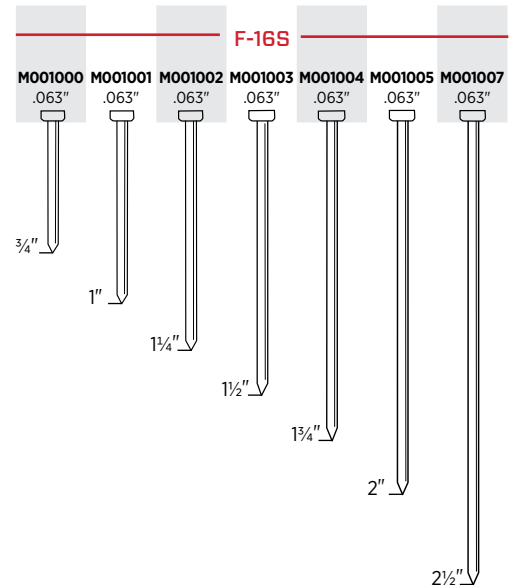

CS-Clamshell, PT-Plastic Tub

FUSION CORDLESS FASTENERS

15^{GA}
34°

Angled Strip Finish Nails

Furniture and cabinets, molding and trim, baseboard, chair rails, doors and window casings

Length	Point	Head	Finish	Coating	Collation	Box Count	Item Code
1"	Chisel	Brad	Bright	Sencote	34° Angled Taped Strip	4M	DA13EPBN
1¼"	Chisel	Brad	Bright	Sencote	34° Angled Taped Strip	4M	DA15EPBN
1½"	Chisel	Brad	Bright	Sencote	34° Angled Taped Strip	4M	DA17EPBN
1¾"	Chisel	Brad	Bright	Sencote	34° Angled Taped Strip	4M	DA19EPBN
2"	Chisel	Brad	Bright	Sencote	34° Angled Taped Strip	4M	DA21EPBN
2½"	Chisel	Brad	Bright	Sencote	34° Angled Taped Strip	4M	DA23EPBN
2½"	Chisel	Brad	Bright	Sencote	34° Angled Taped Strip	3M	DA25EPB
1½"	Chisel	Brad	Bright	Sencote	34° Angled Taped Strip	0.7M (CS)	A301500
1¾"	Chisel	Brad	Bright	Sencote	34° Angled Taped Strip	0.7M (CS)	A301750
2"	Chisel	Brad	Bright	Sencote	34° Angled Taped Strip	0.7M (CS)	A302000
2½"	Chisel	Brad	Bright	Sencote	34° Angled Taped Strip	0.7M (CS)	A302500
1¼"	Chisel	Brad	Galv	Sencote	34° Angled Taped Strip	4M	DA15EABN
1½"	Chisel	Brad	Galv	Sencote	34° Angled Taped Strip	4M	DA17EABN
1¾"	Chisel	Brad	Galv	Sencote	34° Angled Taped Strip	4M	DA19EABN
2"	Chisel	Brad	Galv	Sencote	34° Angled Taped Strip	4M	DA21EABN
2½"	Chisel	Brad	Galv	Sencote	34° Angled Taped Strip	3M	DA25EAB
2"	Chisel	Brad	Galv	Sencote	34° Angled Taped Strip	0.7M (CS)	A302009
2½"	Chisel	Brad	Galv	Sencote	34° Angled Taped Strip	0.7M (CS)	A302509
2"	Chisel	Brad	Stainless 304	Sencote	34° Angled Taped Strip	2M	DA21EGBN
2½"	Chisel	Brad	Stainless 304	Sencote	34° Angled Taped Strip	1.2M	DA25EGB
1¼"	Diamond	Brad	Hardened*	Plain	34° Angled Taped Strip	4M	DA15AIA
1½"	Diamond	Brad	Hardened*	Plain	34° Angled Taped Strip	4M	DA17AIA
1¾"	Diamond	Brad	Hardened*	Plain	34° Angled Taped Strip	4M	DA19AIA

CS-Clamshell

*Hardened regular galvanized heat treated 15 gauge for steel stud and trim applications

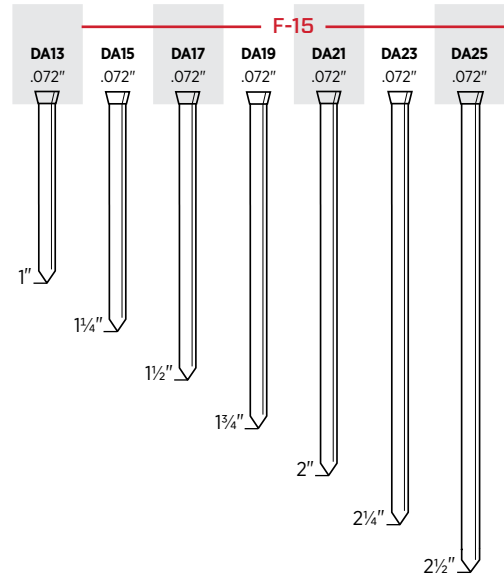

Maximize Your Fusion Cordless Convenience.

SESCO® manufactures multiple varieties of finish nails available in 4 finishes and 12 lengths.



FINISH & WOODWORKING

THE DIFFERENCE IS IN THE DETAILS

SENCO has set the industry standard for finish and fine woodworking tools, providing compact, ultra-light, easy-to-use tools designed for precision and longevity.

We offer a broader range of tools than anyone else, covering 15–23 gauge nailers and 15–18 gauge staplers, including the award-winning 21 gauge FinishPro® 21LXP.

APPLICATIONS

Cabinetry, furniture, decorative trim, crown molding, custom woodworking applications and all other finish needs

FEATURES

- EZ-Clear™ latch to clear jams fast
- No-mar pads to protect woodwork
- Clear line-of-sight for precision fastening
- Comfort grip
- Adjustable depth-of-drive



FinishPro® 23SXP

1 3/8" HEADLESS PINNER

ITEM #8F0001N



23_{GA}

Features

- Powerful — ensures complete drives into hard substrates
- Automatically adjusts for different fastener lengths
- Ergonomic handle for all-day comfort
- Ultra-narrow nose for tight corners
- Includes case, swivel air plug, wrench and tool oil

FinishPro® 23LXP

2" HEADLESS PINNER

ITEM #8L0001N



23_{GA}

Features

- Most powerful tool in its class — ensures complete drives into hard substrates
- Automatically adjusts for different fastener lengths
- Ergonomic handle for all-day comfort
- Ultra-narrow nose for tight corners
- Includes case, swivel air plug, wrench and tool oil

Pins and Brads: 23, 21 & 18 Gauge the new standard when details matter



Product Reference Chart

TOOL SPECS	FinishPro® 23SXP	FinishPro® 23LXP
Trigger	Sequential	Sequential
Operating Pressure	70-100 psi (4.8-7 bar)	70-110 psi (4.8-7.6 bar)
Air Consumption (60 CPM)	1.1 scfm	1.1 scfm
Air Inlet	1/4" NPT	1/4" NPT
Weight	2.5 lbs (1.1 kg)	2.7 lbs (1.2 kg)
Height	7.56" (192 mm)	8.89" (226 mm)
Length	7.87" (200 mm)	7.87" (200 mm)
Width	1.85" (44 mm)	1.85" (44 mm)
Main Body Material	Aluminum	Aluminum
Warranty	5 yrs	5 yrs
FASTENER SPECS	Fasteners are located on page 26	
Gauge	23	23
Range	1/2" - 1 3/8"	1/2" - 2"
Capacity	126	126
Angle/Collation	Straight Glued Strip	Straight Glued Strip
Series	A10, CZ	A10, CZ
TOOL FEATURES		
Depth-of-Drive	No	No
Belt Hook	Yes	Yes
Oil-Less	No	No
Exhaust	Rear	Rear

FinishPro®21LXP

2" PINNER

ITEM #8M0001N



21_{GA}

Features

- Powerful — ensures complete drives into hard substrates
- Automatically adjusts for different fastener lengths
- Ergonomic handle for all-day comfort
- Ultra-narrow nose for tight corners
- Includes case, swivel air plug, wrench and tool oil

LS1XP

1" HEADLESS BRAD NAILER

ITEM #8N0001N



18_{GA}

Features

- Never-Lube® design — no lubrication to stain fine woods
- Ergonomic handle for all-day comfort
- Narrow nose for tight corners

FinishPro®18Mg

2 5/8" BRAD NAILER

ITEM #1U0021N



18_{GA}

Features

- Metal cylinder for increased durability
- EZ-Clear™ latch virtually eliminates downtime caused by fastener jams
- Narrow nose for tight corners
- Includes case, swivel air plug and wrench

FinishPro®18BMg

2 1/8" BRAD NAILER

ITEM #9B0001N



18_{GA}

Features

- Oil-free design — no oil required
- Ultra-lightweight for ease of use and maneuverability
- Nose mounted LED light illuminates dark work spaces
- Includes case, swivel air plug and wrench

Product Reference Chart

TOOL SPECS	FinishPro®21LXP	LS1XP	FinishPro®18Mg	FinishPro®18BMg
Trigger	Sequential	Sequential	Selectable	Selectable
Operating Pressure	70-110 psi (4.8-7.6 bar)	70-120 psi (4.8-8.3 bar)	70-120 psi (4.8-8.3 bar)	70-120 psi (4.8-8.3 bar)
Air Consumption (60 CPM)	1.1 scfm	1.92 scfm	2.4 scfm	1.6 scfm
Air Inlet	1/4" NPT	1/4" NPT	1/4" NPT	1/4" NPT
Weight	3.15 lbs (1.43 kg)	2.9 lbs (1.3 kg)	2.48 lbs (1.12 kg)	2.8 lbs (1.26 kg)
Height	8.89" (226 mm)	8.25" (210 mm)	9.75" (248 mm)	9.8" (248 mm)
Length	7.87" (200 mm)	9" (229 mm)	10.5" (267 mm)	10" (255 mm)
Width	1.85" (44 mm)	2" (51 mm)	2.5" (63.5 mm)	2.5" (63.5 mm)
Main Body Material	Aluminum	Aluminum	Magnesium	Magnesium
Warranty	5 yrs	5 yrs	5 yrs	5 yrs
FASTENER SPECS	Fasteners are located on pages 26-27			
Gauge	21	18	18	18
Range	5/8"-2"	1/2"-1"	5/8"-2 1/8"	5/8"-2 1/8"
Capacity	170	100	110	100
Angle/Collation	Straight Glued Strip	Straight Glued Strip	Straight Glued Strip	Straight Glued Strip
Series	ZX	AZ	AX	AX
TOOL FEATURES				
Depth-of-Drive	No	No	Yes, Tool-Free	Yes, Tool-Free
Belt Hook	Yes	Fixed	Yes	Yes
Oil-Less	No	Yes	Yes	Yes
Exhaust	Rear	Fixed	Rear Adjustable	Rear Adjustable

SLP20XP

1½" BRAD NAILER

ITEM #430101N



18_{GA}

Features

- Never-Lube® design — no oil required
- Drives both slight and medium headed brads
- Muffler ensures quieter operation
- Includes case

FinishPro®25XP

2½" BRAD NAILER

ITEM #760102N



18_{GA}

Features

- Never-Lube® design — no oil required
- Drives both slight and medium headed brads
- Powerful — ensures complete drives into hard substrates
- Includes case

Product Reference Chart

TOOL SPECS	SLP20XP	FinishPro®25XP
Trigger	Sequential	Sequential
Operating Pressure	70-120 psi (4.8-8.3 bar)	70-120 psi (4.8-8.3 bar)
Air Consumption (60 CPM)	1.92 scfm	1.92 scfm
Air Inlet	¼" NPT	¼" NPT
Weight	2.3 lbs (1 kg)	2.7 lbs (1.2 kg)
Height	8.25" (210 mm)	9.9" (251 mm)
Length	9.5" (241 mm)	9.8" (249 mm)
Width	2" (50.8 mm)	2.2" (56 mm)
Main Body Material	Aluminum	Aluminum
Warranty	5 yrs	5 yrs
FASTENER SPECS	Fasteners are located on pages 26-27	
Gauge	18	18
Range	⅝" - 1½"	⅝" - 2½"
Capacity	110	110
Angle/Collation	Straight Glued Strip	Straight Glued Strip
Series	AX, AY	AX, AY
TOOL FEATURES		
Depth-of-Drive	No	Yes, Tool-Free
Belt Hook	No	Yes
Oil-Less	Yes	Yes
Exhaust	Fixed	Adjustable

FinishPro®16XP

2½" FINISH NAILER

ITEM #9S0001N

16_{GA}



Features

- Redesigned EZ-Clear™ latch for quick and easy jam clearing
- Upgraded magazine feed system for consistent, reliable shot performance
- Selectable single fire and bump fire modes
- Tool free depth of drive adjustment

The FinishPro16XP: the finish nailer, redefined.

- Rugged, lightweight magnesium body.
- EZ-Clear™ latch system.
- Upgraded magazine system virtually eliminates downtime and fastener jamming.
- Takes brad nails from 1¼" to 2½".



Product Reference Chart

TOOL SPECS	FinishPro®16XP
Trigger	Selectable
Operating Pressure	70-120 psi (4.8-8.3 bar)
Air Consumption (60 CPM)	2.22 scfm
Air Inlet	¼" NPT
Weight	4.0 lbs (1.8 kg)
Height	11.4" (290 mm)
Length	12" (305 mm)
Width	4" (102 mm)
Main Body Material	Magnesium
Warranty	5 yrs
FASTENER SPECS	Fasteners are located on page 27
Gauge	16
Range	1¼"-2½"
Capacity	110
Angle/Collation	Straight Glued Strip
Series	A4, MO
TOOL FEATURES	
Depth-of-Drive	Yes, Tool-Free
Belt Hook	Yes
Oil-Less	No
Exhaust	Adjustable

FinishPro® 30XP

2" ANGLED FINISH NAILER

ITEM #9P0002N



15^{GA}
34°

Features

- Never-Lube® design — no oil required
- EZ-Clear™ latch virtually eliminates downtime caused by fastener jams
- Adjustable depth of drive
- Includes case and belt hook

FinishPro® 35Mg

2½" ANGLED FINISH NAILER

ITEM #6G0001N



15^{GA}
34°

Features

- EZ-Clear™ latch virtually eliminates downtime caused by fastener jams
- Integrated air blower clears debris from work surface
- Metal cylinder for increased durability
- Includes case, swivel air plug and wrench

FinishPro® 42XP

2½" ANGLED FINISH NAILER

ITEM #4G0001N



15^{GA}
34°

Features

- Never-Lube® design — no oil required
- EZ-Clear™ latch virtually eliminates downtime caused by fastener jams
- High-strength driver with threaded connection
- Metal cylinder for increased durability
- Includes case, belt hook and contact trigger kit

Product Reference Chart

TOOL SPECS	FinishPro®30XP	FinishPro®35Mg	FinishPro®42XP
Trigger	Sequential	Selectable	Sequential
Operating Pressure	70-120 psi (4.8-8.3 bar)	70-120 psi (4.8-8.3 bar)	70-120 psi (4.8-8.3 bar)
Air Consumption (60 CPM)	2.16 scfm	3.2 scfm	3.87 scfm
Air Inlet	¼" NPT	¼" NPT	¼" NPT
Weight	3.8 lbs (1.73 kg)	4.2 lbs (1.9 kg)	4.7 lbs (2.1 kg)
Height	9.63" (244.6 mm)	12.25" (311 mm)	11.25" (286 mm)
Length	12" (305 mm)	13" (330 mm)	13" (330 mm)
Width	3.25" (82.5 mm)	3.5" (89 mm)	3.5" (89 mm)
Main Body Material	Magnesium	Magnesium	Magnesium
Warranty	5 yrs	5 yrs	5 yrs
FASTENER SPECS	Fasteners are located on page 28		
Gauge	15	15	15
Range	1"-2"	1¼"-2½"	1¼"-2½"
Capacity	104	110	104
Angle/Collation	34° Angled Tape Strip	34° Angled Tape Strip	34° Angled Tape Strip
Series	DA	DA	DA
TOOL FEATURES			
Depth-of-Drive	Yes, Tool-Free	Yes, Tool-Free	Yes, Tool-Free
Belt Hook	Yes	Yes	Yes
Oil-Less	Yes	Yes	Yes
Exhaust	Fixed	Adjustable	Adjustable

SLS20XP

3/16", 1/4", 3/8" CROWNS, 1 1/2" FINE/MEDIUM WIRE STAPLER

SEE ITEM # CHART



19^{GA} 18^{GA}

Features

- Never-Lube® design — no oil required
- Ultra-lightweight for ease of use and maneuverability
- Metal cylinder for increased durability
- Muffler ensures quieter operation

SKSXP

1/4", 3/8", 7/16" CROWNS, 1 1/2" MEDIUM/HEAVY WIRE STAPLER

SEE ITEM # CHART



18^{GA} 16^{GA}

Features

- Never-Lube® design — no oil required
- EZ-Clear™ latch virtually eliminates downtime caused by fastener jams
- Long 1" lip to get into tight spots

SLS25XP

1/4", 3/8" CROWNS, 1 1/2" MEDIUM WIRE STAPLER

SEE ITEM # CHART



18^{GA}

Features

- Never-Lube® design — no oil required
- Ultra-lightweight for ease of use and maneuverability
- Metal cylinder for increased durability
- Muffler ensures quieter operation

SLS20XP, SLS25XP and SKSXP Item Code Chart

Model	Item Code
SLS20XP-K	490101N
SLS20XP-L	490103N
SLS20XP-L W/CASE	490105N
SLS20XP-L SENCOMATIC	490015N
SLS20XP-M	490107N
SLS20XP-R	490111N
SLS25XP-L	820103N
SLS25XP-M	820107N
SKSXP-L	300120N
SKSXP-M	300152N
SKSXP-N	300184N

Product Reference Chart

TOOL SPECS	SLS20XP	SLS25XP	SKSXP
Trigger	Sequential	Contact	Sequential
Operating Pressure	70-120 psi (4.8-8.3 bar)	70-120 psi (4.8-8.3 bar)	70-120 psi (4.8-8.3 bar)
Air Consumption (60 CPM)	1.92 scfm	1.92 scfm	2.16 scfm
Air Inlet	1/4" NPT	1/4" NPT	1/4" NPT
Weight	2.5 lbs (1.13 kg)	2.67 lbs (1.21 kg)	4.2 lbs (1.9 kg)
Height	8.5" (216 mm)	9" (229 mm)	9.25" (238 mm)
Length	12" (305 mm)	12" (305 mm)	12.38" (314 mm)
Width	2" (50.8 mm)	2" (50.8 mm)	3" (76 mm)
Main Body Material	Aluminum	Aluminum	Aluminum
Warranty	5 yrs	5 yrs	5 yrs
FASTENER SPECS	Fasteners are located on pages 29-30		
Gauge	19, 18	18	18, 16
Crown	3/16", 1/4", 3/8"	1/4", 3/8"	1/4", 3/8", 7/16"
Range	3/8"-1 1/2"	3/8"-1 1/2"	3/4"-1 1/2"
Capacity	168	168	145
Angle/Collation	Straight Glued Strip	Straight Glued Strip	Straight Glued Strip
Series	K, L, M, R	L, M	L, M, N
TOOL FEATURES			
Depth-of-Drive	Yes	Yes	No
Belt Hook	No	No	No
Oil-Less	Yes	Yes	Yes

SLS150Mg

¼" CROWN, 1½" MEDIUM WIRE STAPLER

ITEM #8C0001N



18_{GA}

Features

- Ultra-lightweight for ease of use and maneuverability
- Nose-mounted LED light — illuminates work surface
- Durable composite magazine
- Reload indicator on magazine
- Includes case and wrench

SLS18Mg

¼" CROWN, 1½" MEDIUM WIRE STAPLER

ITEM #1W0021N



18_{GA}

Features

- Ultra-lightweight for ease of use and maneuverability
- Metal cylinder for increased durability
- Reload indicator on magazine
- Includes case, swivel air plug and wrench

SC1XP Senclamp®

7/16" CROWN, 9/16" SENCLAMP® FASTENER

ITEM #220101N



25_{GA}

Features

- Senclamp® fasteners pull the joint together during driving for a tight, permanent fit
- Eliminates milling, doweling, clamping, screwing and other time-consuming, cost-adding operations
- The Senclamp high-carbon steel fastener derives added strength from its special webbed design

SC2 Sencor®

1" CROWN, ½" CORRUGATED STAPLER

ITEM #470001N



25_{GA}

Features

- Powerful — ensures complete drives into hard substrates
- Eliminates gluing, milling, doweling, screwing and clamping
- Added strength for larger butt joints

Product Reference Chart

TOOL SPECS	SLS150Mg	SLS18Mg	SC1XP Senclamp®	SC2 Sencor®
Trigger	Selectable	Selectable	Sequential	Sequential
Operating Pressure	70-120 psi (4.8-8.3 bar)	70-120 psi (4.8-8.3 bar)	80-110 psi (5.5-7.5 bar)	80-110 psi (5.5-7.5 bar)
Air Consumption (60 CPM)	2.4 scfm	2.4 scfm	3.8 scfm	3.7 scfm
Air Inlet	¼" NPT	¼" NPT	⅜" NPT	⅜" NPT
Weight	2.6 lbs (1.8 kg)	2.6 lbs (1.8 kg)	6.3 lbs (2.8 kg)	6.9 lbs (3.1 kg)
Height	9.5" (241 mm)	9.5" (241 mm)	9.8" (249 mm)	9.44" (240 mm)
Length	10.25" (260 mm)	10.25" (260 mm)	12.7" (322 mm)	12.5" (318 mm)
Width	2.5" (63.5 mm)	2.5" (63.5 mm)	2.5" (63.5 mm)	2" (50.8 mm)
Main Body Material	Magnesium	Magnesium	Aluminum	Aluminum
Warranty	5 yrs	5 yrs	5 yrs	5 yrs
FASTENER SPECS	Fasteners are located on pages 29, 31			
Gauge	18	18	25	25
Crown	¼"	¼"	7/16"	1"
Range	½"-1½"	⅜"-1½"	5/16"-9/16"	¼"-½"
Capacity	110	110	120	80
Angle/Collation	Straight Glued & Taped Strip	Straight Glued & Taped Strip	Straight Glued & Taped Strip	Straight Glued Strip
Series	L	L	Y	X
TOOL FEATURES				
Depth-of-Drive	Yes, Tool-Free	Yes, Tool-Free	No	No
Belt Hook	Yes	Yes	No	No
Oil-Less	Yes	Yes	No	No

23^{GA}

Headless Straight Strip Pins

Pins fasten the smallest of trim securely leaving a nearly invisible hole

Length	Point	Head	Finish	Coating	Collation	Box Count	Item Code
5/8"	Chisel	Headless	Galv	Plain	Straight Glued Strip	10M	CZ10EAA
3/4"	Chisel	Headless	Galv	Plain	Straight Glued Strip	10M	CZ11EAA
1"	Chisel	Headless	Galv	Plain	Straight Glued Strip	10M	CZ13EAA
1 1/4"	Chisel	Headless	Galv	Plain	Straight Glued Strip	10M	CZ15EAA
1 3/8"	Chisel	Headless	Galv	Plain	Straight Glued Strip	10M	CZ16EAA
1 1/2"	Chisel	Headless	Galv	Plain	Straight Glued Strip	10M	CZ17EAA
1/2"	Chisel	Headless	Galv	Plain	Straight Glued Strip	2.6M (CS)	A100509
5/8"	Chisel	Headless	Galv	Plain	Straight Glued Strip	2.6M (CS)	A100629
3/4"	Chisel	Headless	Galv	Plain	Straight Glued Strip	2.6M (CS)	A100759
1"	Chisel	Headless	Galv	Plain	Straight Glued Strip	2.6M (CS)	A101009
1 1/4"	Chisel	Headless	Galv	Plain	Straight Glued Strip	2.6M (CS)	A101259
1 3/8"	Chisel	Headless	Galv	Plain	Straight Glued Strip	2.6M (CS)	A101379
1 1/2"	Chisel	Headless	Galv	Plain	Straight Glued Strip	2.6M (CS)	A101509
2"	Chisel	Headless	Galv	Plain	Straight Glued Strip	2.6M (CS)	A102009
1/2"-1"	Chisel	Headless	Galv	Plain	Straight Glued Strip	2.5M (CS)	A109809*
1"-2"	Chisel	Headless	Galv	Plain	Straight Glued Strip	2.5M (CS)	A109909*

CS-Clamshell, *Variety Pack

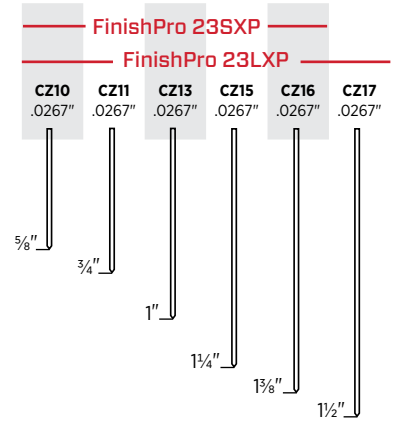

21^{GA}

Medium Straight Strip Head Pins

21 gauge pins offer significantly more holding power than 23 gauge pins while leaving a much smaller indent than an 18 gauge brad

Length	Point	Head	Finish	Coating	Collation	Box Count	Item Code
5/8"	Chisel	Medium	Galv	Plain	Straight Glued Strip	5M	ZX10EAA
1"	Chisel	Medium	Galv	Plain	Straight Glued Strip	5M	ZX13EAA
1 3/8"	Chisel	Medium	Galv	Plain	Straight Glued Strip	5M	ZX16EAA
1 5/8"	Chisel	Medium	Galv	Plain	Straight Glued Strip	5M	ZX18EAA
2"	Chisel	Medium	Galv	Plain	Straight Glued Strip	5M	ZX21EAA

CS-Clamshell

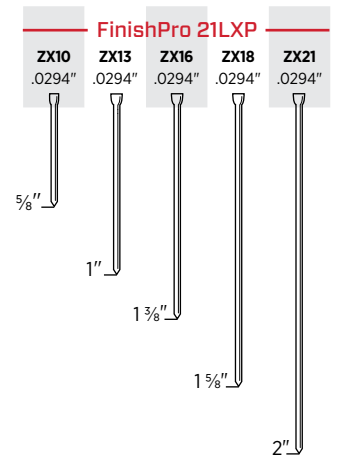

18^{GA}

Straight Strip Brad Nails

Cabinets, decorative trim, picture frames and molding

Length	Point	Head	Finish	Coating	Collation	Box Count	Item Code
5/8"	Chisel	Medium	Galv	Plain	Straight Glued Strip	5M	AX10EAA
3/4"	Chisel	Medium	Galv	Plain	Straight Glued Strip	5M	AX11EAA
1"	Chisel	Medium	Galv	Plain	Straight Glued Strip	5M	AX13EAA
1 1/4"	Chisel	Medium	Galv	Plain	Straight Glued Strip	5M	AX15EAA
1 1/2"	Chisel	Medium	Galv	Plain	Straight Glued Strip	5M	AX17EAA
1 5/8"	Chisel	Medium	Galv	Plain	Straight Glued Strip	5M	AX18EAA
1 3/4"	Chisel	Medium	Galv	Plain	Straight Glued Strip	5M	AX19EAA
2"	Chisel	Medium	Galv	Plain	Straight Glued Strip	5M	AX21EAA
2 1/8"	Chisel	Medium	Galv	Plain	Straight Glued Strip	5M	AX22EAA
1"	Chisel	Medium	Galv	Plain	Straight Glued Strip	1M (CS)	A201009
1 1/4"	Chisel	Medium	Galv	Plain	Straight Glued Strip	1M (CS)	A201259
1 1/2"	Chisel	Medium	Galv	Plain	Straight Glued Strip	0.8M (CS)	A201509
2"	Chisel	Medium	Galv	Plain	Straight Glued Strip	0.8M (CS)	A202009
5/8"-1 3/4"	Chisel	Medium	Galv	Plain	Straight Glued Strip	1.2M (CS)	A209809*
1-2"	Chisel	Medium	Galv	Plain	Straight Glued Strip	1.2M (CS)	A209909*

CS-Clamshell, *Variety Pack

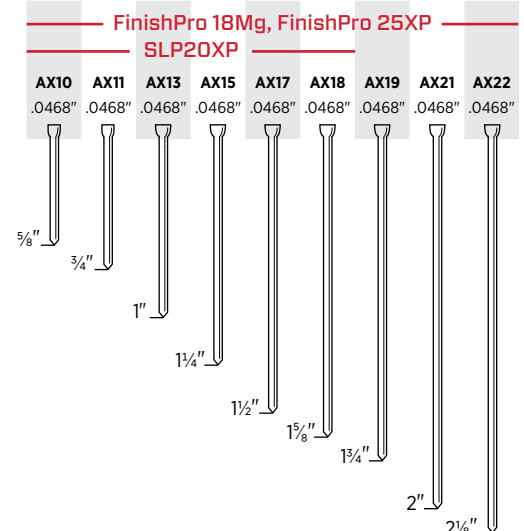

FINISH & WOODWORKING FASTENERS

18^{GA}

Headless and Slight Head Brad Nails

Cabinets, decorative trim, picture frames and molding

Length	Point	Head	Finish	Coating	Collation	Box Count	Item Code
½"	Chisel	Headless	Galv	Plain	Straight Glued Strip	5M	AZ08EAA
¾"	Chisel	Headless	Galv	Plain	Straight Glued Strip	5M	AZ11EAA
1"	Chisel	Headless	Galv	Plain	Straight Glued Strip	5M	AZ13EAA
⅝"	Chisel	Slight	Galv	Plain	Straight Glued Strip	5M	AY10EAA
¾"	Chisel	Slight	Galv	Plain	Straight Glued Strip	5M	AY11EAA
1"	Chisel	Slight	Galv	Plain	Straight Glued Strip	5M	AY13EAA

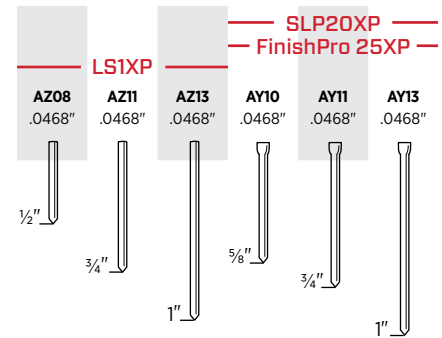

16^{GA}

Straight Strip Finish Nails

Furniture and cabinets, molding and trim, baseboard, chair rails, window casings and upholstery trim panels

Length	Point	Head	Finish	Coating	Collation	Box Count	Item Code
¾"	Chisel	T-head	Galv	Plain	Straight Glued Strip	2M	M001000
1"	Chisel	T-head	Galv	Plain	Straight Glued Strip	2M (PT)	M001001
1¼"	Chisel	T-head	Galv	Plain	Straight Glued Strip	2M (PT)	M001002
1½"	Chisel	T-head	Galv	Plain	Straight Glued Strip	2M (PT)	M001003
1¾"	Chisel	T-head	Galv	Plain	Straight Glued Strip	2M (PT)	M001004
2"	Chisel	T-head	Galv	Plain	Straight Glued Strip	2M (PT)	M001005
2½"	Chisel	T-head	Galv	Plain	Straight Glued Strip	2M (PT)	M001007
1½"	Chisel	T-head	Galv	Plain	Straight Glued Strip	0.7M (CS)	A401509
2"	Chisel	T-head	Galv	Plain	Straight Glued Strip	0.7M (CS)	A402009
2½"	Chisel	T-head	Galv	Plain	Straight Glued Strip	0.7M (CS)	A402509

CS-Clamshell, PT-Plastic Tub

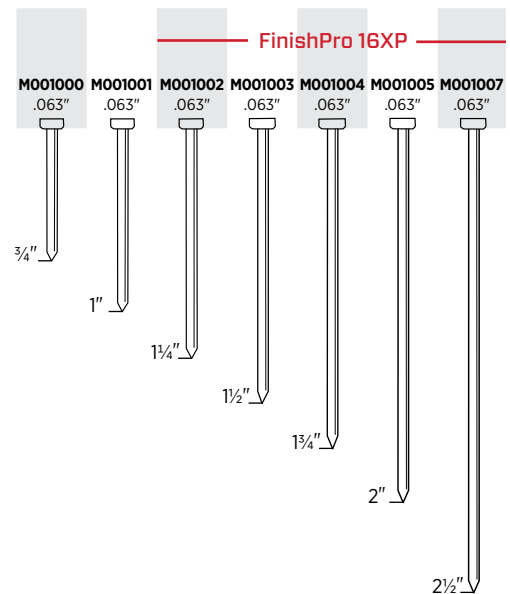

15^{GA}
34°

Angled Strip Finish Nails

Furniture and cabinets, molding and trim, baseboard, chair rails, doors and window casings

Length	Point	Head	Finish	Coating	Collation	Box Count	Item Code
1"	Chisel	Brad	Bright	Sencote	34° Angled Tape Strip	4M	DA13EPBN
1¼"	Chisel	Brad	Bright	Sencote	34° Angled Tape Strip	4M	DA15EPBN
1½"	Chisel	Brad	Bright	Sencote	34° Angled Tape Strip	4M	DA17EPBN
1¾"	Chisel	Brad	Bright	Sencote	34° Angled Tape Strip	4M	DA19EPBN
2"	Chisel	Brad	Bright	Sencote	34° Angled Tape Strip	4M	DA21EPBN
2¼"	Chisel	Brad	Bright	Sencote	34° Angled Tape Strip	4M	DA23EPBN
2½"	Chisel	Brad	Bright	Sencote	34° Angled Tape Strip	3M	DA25EPB
1½"	Chisel	Brad	Bright	Sencote	34° Angled Tape Strip	0.7M (CS)	A301500
1¾"	Chisel	Brad	Bright	Sencote	34° Angled Tape Strip	0.7M (CS)	A301750
2"	Chisel	Brad	Bright	Sencote	34° Angled Tape Strip	0.7M (CS)	A302000
2½"	Chisel	Brad	Bright	Sencote	34° Angled Tape Strip	0.7M (CS)	A302500
1¼"	Chisel	Brad	Galv	Sencote	34° Angled Tape Strip	4M	DA15EABN
1½"	Chisel	Brad	Galv	Sencote	34° Angled Tape Strip	4M	DA17EABN
1¾"	Chisel	Brad	Galv	Sencote	34° Angled Tape Strip	4M	DA19EABN
2"	Chisel	Brad	Galv	Sencote	34° Angled Tape Strip	4M	DA21EABN
2½"	Chisel	Brad	Galv	Sencote	34° Angled Tape Strip	3M	DA25EAB
2"	Chisel	Brad	Galv	Sencote	34° Angled Tape Strip	0.7M (CS)	A302009
2½"	Chisel	Brad	Galv	Sencote	34° Angled Tape Strip	0.7M (CS)	A302509
2"	Chisel	Brad	Stainless 304	Plain	34° Angled Tape Strip	2M	DA21EGBN
2½"	Chisel	Brad	Stainless 304	Plain	34° Angled Tape Strip	1.2M	DA25EGB
1¼"	Diamond	Brad	Hardened*	Plain	34° Angled Tape Strip	4M	DA15AIA
1½"	Diamond	Brad	Hardened*	Plain	34° Angled Tape Strip	4M	DA17AIA
1¾"	Diamond	Brad	Hardened*	Plain	34° Angled Tape Strip	4M	DA19AIA

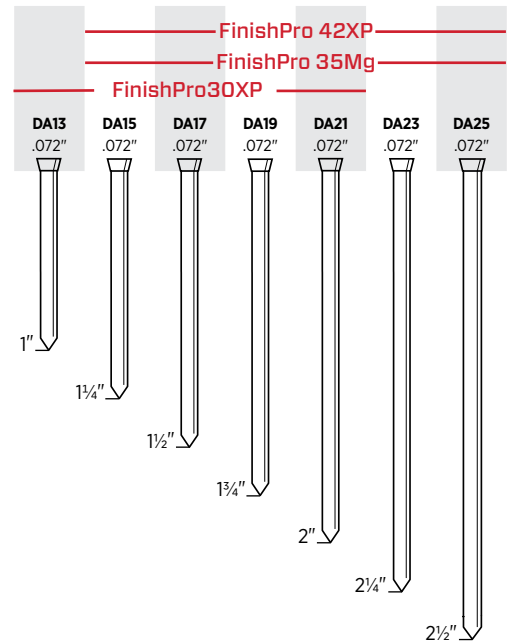

CS-Clamshell

*Hardened regular galvanized heat treated 15 Gauge for steel stud and trim applications

The Best Finish Nails in the Business.

SENCO® has the finish nails to meet all your finish and trim needs. In addition to offering a wide variety of fastener ranges and gauges, we provide a full line of tools to drive them.



MAKING HARD WORK EASIER

FINISH & WOODWORKING FASTENERS

19^{GA} 1/4" Crown Medium Wire Staples

Cabinets, drawers, soffits, lattice, casebacks						
Length	Point	Finish	Coating	Collation	Box Count	Item Code
3/4"	Chisel	Galv	Sencote	Glued	10M	K11BAB
7/8"	Chisel	Galv	Sencote	Glued	5M	K12BAB
1"	Chisel	Galv	Sencote	Glued	5M	K13BABN

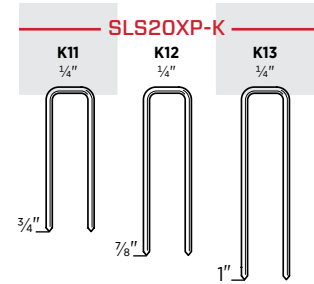

19^{GA} 3/16" Crown Medium Wire Staples

Cabinets, drawers, lattice, laminated hardwood flooring						
Length	Point	Finish	Coating	Collation	Box Count	Item Code
1/2"	Blunt	Galv	Sencote	Glued	10M	R08BAB
5/8"	Blunt	Galv	Sencote	Glued	5M	R10BAB
3/4"	Blunt	Galv	Sencote	Glued	5M	R11BAB
1"	Blunt	Galv	Sencote	Glued	5M	R13BAB

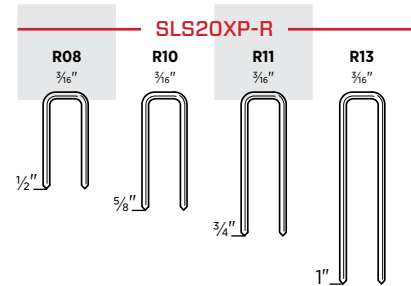

18^{GA} 1/4" Crown Medium Wire Staples

Cabinets, casebacks, drawers, upholstery, soffits, underlayment, lattice and insulation sheathing						
Length	Point	Finish	Coating	Collation	Box Count	Item Code
3/4"	Chisel	Bright	Sencote	Glued	5M	L11BRB
1"	Chisel	Bright	Sencote	Glued	5M	L13BRBN
1"	Chisel	Bright	Sencote	Glued	40M	L13BRBP
1 1/8"	Chisel	Bright	Sencote	Glued	5M	L14BRB
1 1/4"	Chisel	Bright	Sencote	Glued	5M	L15BRB
3/8"	Chisel	Galv	Sencote	Glued	10M	L06BAB
7/16"	Chisel	Galv	Sencote	Glued	24M	L07BABP
1/2"	Chisel	Galv	Sencote	Glued	10M	L08BAB
5/8"	Chisel	Galv	Sencote	Glued	5M	L10BABN
5/8"	Cross Cut	Galv	Sencote	Glued	5M	L10HABN
3/4"	Chisel	Galv	Sencote	Glued	5M	L11BAB
3/4"	Cross Cut	Galv ¹	Sencote	Glued	5M	L11HBB
3/4"	Cross Cut	Galv	Sencote	Glued	5M	L11HAB
7/8"	Chisel	Galv	Sencote	Glued	5M	L12BAB
7/8"	Chisel	Galv	Sencote	Glued	5M	L12QBQ
1"	Chisel	Galv	Sencote	Glued	5M	L13BABN
1"	Cross Cut	Galv	Sencote	Glued	5M	L13HABN
1 1/8"	Chisel	Galv	Sencote	Glued	5M	L14BAB
1 1/4"	Chisel	Galv	Sencote	Glued	5M	L15BAB
1 1/2"	Chisel	Galv	Sencote	Glued	5M	L17BAB
5/8"	Chisel	Galv	Sencote	Glued	1.2M (CS)	A800629
3/4"	Chisel	Galv	Sencote	Glued	0.9M (CS)	A800759
1"	Chisel	Galv	Sencote	Glued	0.9M (CS)	A801009
1 1/4"	Chisel	Galv	Sencote	Glued	0.7M (CS)	A801259
1 1/2"	Chisel	Galv	Sencote	Glued	0.6M (CS)	A801509
1/2"-1 1/2"	Chisel	Galv	Sencote	Glued	0.9M (CS)	A809909*
5/8"	Chisel	Stainless 304 ²	Plain	Glued	5M	L10BHA
3/4"	Chisel	Stainless 304	Plain	Glued	5M	L11BGA
1 1/8"	Chisel	Stainless 304	Plain	Glued	5M	L14BGA

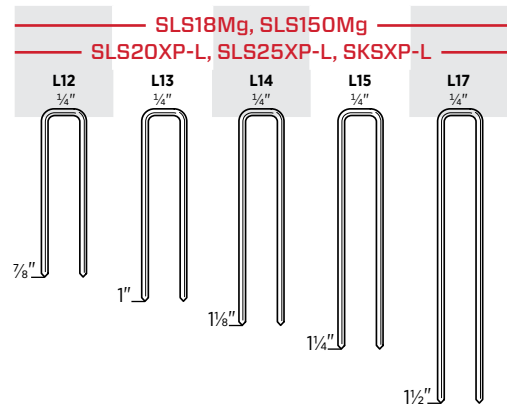
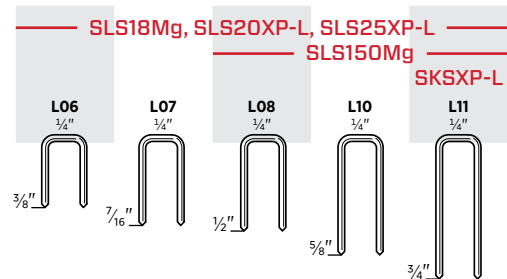

¹ Galvanized High Tensile, ² Stainless 304 Steel High Tensile
CS-Clamshell, *Variety Pack

18^{GA} 3/8" Crown Medium Wire Staples

Cabinets, casebacks, drawers, upholstery, soffits, underlayment, lattice and sheathing

Length	Point	Finish	Coating	Collation	Box Count	Item Code
5/8"	Chisel	Bright	Sencote	Glued	5M	M10BRBN
3/4"	Chisel	Bright	Sencote	Glued	5M	M11BRBN
1"	Chisel	Bright	Sencote	Glued	5M	M13BRB
3/8"	Chisel	Galv	Sencote	Glued	10M	M06BABN
1/2"	Chisel	Galv	Sencote	Glued	10M	M08BAB
5/8"	Chisel	Galv	Sencote	Glued	5M	M10BABN
3/4"	Chisel	Galv	Sencote	Glued	5M	M11BABN
7/8"	Chisel	Galv	Sencote	Glued	5M	M12BAB
1"	Chisel	Galv	Sencote	Glued	5M	M13BAB
1 1/4"	Chisel	Galv	Sencote	Glued	10M	M15BAB
1 1/2"	Chisel	Galv	Sencote	Glued	10M	M17BAB

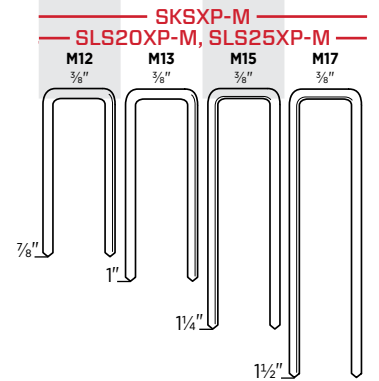
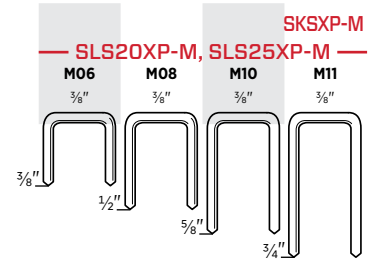

16^{GA} 7/16" Crown Heavy Wire Staples

Cabinets, casebacks, drawers, upholstery, soffits, underlayment, lattice and sheathing

Length	Point	Finish	Coating	Collation	Box Count	Item Code
3/4"	Chisel	Bright	Sencote	Glued	5M	N11BRB
1"	Chisel	Bright	Sencote	Glued	5M	N13BRB
1 1/8"	Chisel	Bright	Sencote	Taped	10M	N14BRB
1 1/4"	Chisel	Bright	Sencote	Taped	10M	N15BRB
1 3/8"	Chisel	Bright	Sencote	Taped	10M	N16BRB
1 1/2"	Chisel	Bright	Sencote	Taped	10M	N17BRB
1 5/8"	Chisel	Bright	Sencote	Taped	10M	N18BRB
1 3/4"	Chisel	Bright	Sencote	Taped	10M	N19BRB
2"	Chisel	Bright	Sencote	Taped	10M	N21BRB
1/2"	Chisel	Galv	Sencote	Taped	5M	N08BABN
1/2"	Chisel	Galv*	Sencote	Glued	5M	N08BBBN
1/2"	Diverg	Galv*	Sencote	Glued	5M	N08FBFB
5/8"	Chisel	Galv	Sencote	Glued	5M	N10BAB
3/4"	Chisel	Galv	Sencote	Glued	5M	N11BAB
3/4"	Diverg	Galv*	Sencote	Glued	5M	N11FBFB
7/8"	Chisel	Galv	Sencote	Glued	5M	N12BABN
7/8"	Diverg	Galv	Sencote	Glued	5M	N12FBFB
1"	Chisel	Galv	Sencote	Glued	5M	N13BAB
1"	Diverg	Galv	Sencote	Glued	5M	N13FBFB
1 1/8"	Chisel	Galv	Sencote	Taped	10M	N14BAB
1 1/4"	Chisel	Galv	Sencote	Taped	10M	N15BAB
1 1/4"	Diverg	Galv	Sencote	Glued	10M	N15FBFB
1 3/8"	Chisel	Galv	Sencote	Taped	10M	N16BAB
1 1/2"	Chisel	Galv	Sencote	Taped	10M	N17BAB
1 1/2"	Chisel	Galv	Sencote	Glued	10M	N17BPE
1 5/8"	Chisel	Galv	Sencote	Taped	10M	N18BAB
1 3/4"	Chisel	Galv	Sencote	Taped	10M	N19BAB
1 3/4"	Chisel	Galv	Sencote	Glued	10M	N19BPE
2"	Chisel	Galv	Sencote	Taped	10M	N21BAB
2"	Chisel	Galv	Sencote	Glued	10M	N21BPE
1 1/4"	Chisel	Stainless 304	Sencote	Glued	3M	N15BGB
1 1/2"	Chisel	Stainless 304	Sencote	Glued	3M	N17BGB
1 3/4"	Chisel	Stainless 304	Sencote	Glued	3M	N19BGBN
2"	Chisel	Stainless 304	Sencote	Glued	3M	N21BGBN

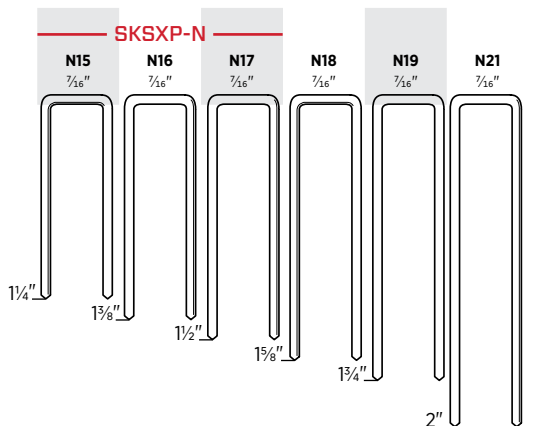
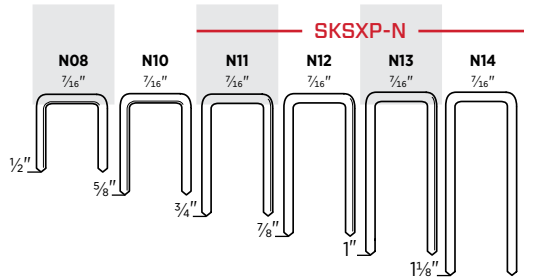

*Galvanized High Tensile

25^{GA} Sencor® 1" Crown Corrugated Fastener

Butt and miter joints

Length	Point	Finish	Coating	Collation	Box Count	Item Code
¼"	Sharp Chisel	Bright	Plain	Glued	8M	X04NRA
⅜"	Sharp Chisel	Bright	Plain	Glued	5M	X06NRA
½"	Sharp Chisel	Bright	Plain	Glued	4M	X08NRA

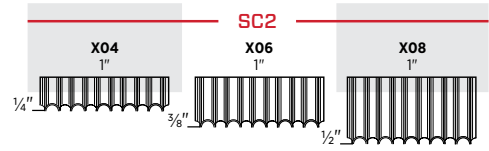

SENCOR® CORRUGATED FASTENERS

Sencor corrugated fasteners provide twice the joint strength of ordinary fasteners. Available in 1" crown and ¼", ⅜" and ½" lengths to ensure maximum joint strength. Use this fastener for butt and miter joints, truss construction, wooden boxes, pallet repair, cabinet and furniture frames.

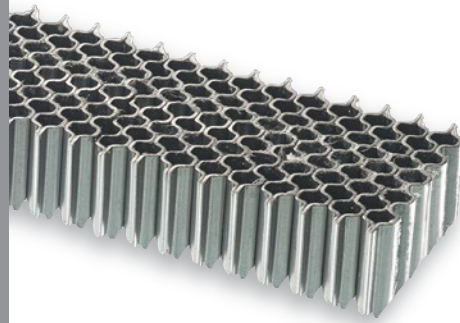

25^{GA} Senclamp® 7/16" Crown Joint Fastener

Butt and miter joints

Length	Point	Finish	Coating	Collation	Box Count	Item Code
5/16"	Chisel	Bright	Plain	Taped	3M	Y05BFA
7/16"	Chisel	Bright	Plain	Taped	3M	Y07BFA
9/16"	Chisel	Bright	Plain	Taped	3M	Y09BFA

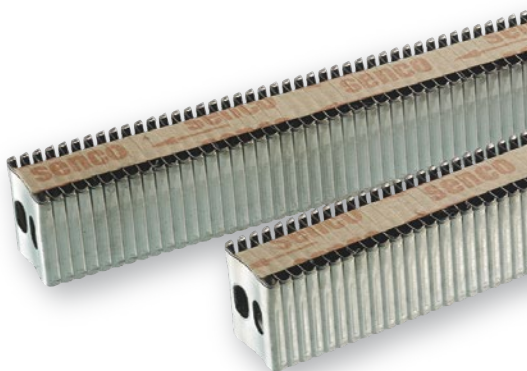
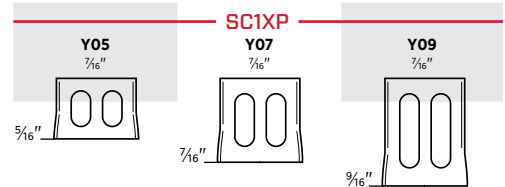

SENCLAMP® JOINT FASTENERS

Senclamp has a special webbed design that draws the material together as it drives through it. Made from carbon steel, fasteners are available in 7/16" crown and 5/16", 7/16" and 9/16" lengths to best suit your requirements. Designed for a wide range of joint fastening applications, Senclamp secures joints better, faster and for less.

FRAMING, SHEATHING & SUBFLOOR

NAILING THE RIGHT BALANCE OF SIZE, WEIGHT AND POWER

We offer a wide selection of strip and coil framing and sheathing nailers, including the award winning FramePro®325XP.

- Compact to maneuver around wall studs and floor joists easily
- Lightweight and ergonomic to reduce fatigue
- Built tough and powerful enough to drive fasteners into the most demanding substrates

APPLICATIONS

Framing, sheathing, truss building, installing subflooring, decking or fencing, assembling boxes or making pallets

FEATURES

- Low profile designs allow for easy access between studs and joists
- Highly efficient internal design for increased durability and less wear and tear on the compressor
- Dry fire lock out prevents dry firing and signals user when to reload
- Claw-like safety for precise toe-nailing



FramePro®325XP

3/4" PAPER TAPE FRAMING NAILER

ITEM #4Z0101N



34°

Features

- Patented TrueDrive magazine reduces jams and misfeeds
- Efficient internal design means less wear and tear on the compressor
- Claw-like toenail safety
- Fits easily between studs and joists

FramePro®701XP

3/2" PAPER TAPE FRAMING NAILER

ITEM #2H0133N



34°

Features

- Straight-line 34° magazine for better line of sight
- Simple two-step loading
- Claw-like toenail safety
- Fits easily between studs and joists
- Double length magazine conversion kit (YJ0043) also available

FramePro®751XP

3/2" PAPER TAPE FRAMING NAILER

ITEM #2J0103N



34°

Features

- Straight-line 34° magazine for better line of sight
- Simple two-step loading
- Claw-like toenail safety
- Fits easily between studs and joists
- 4" feed system conversion kit (YJ0042) also available

Magazine Retrofit Kit (Sold Separately)

Updated magazine options		
FITS TOOLS	DESCRIPTION	ITEM #
FramePro701XP	2-Nail Strip Magazine Retrofit Kit	YJ0055
FramePro701XP	Double Length Magazine Retrofit Kit	YJ0043
FramePro751XP	4" Nail Feed System Retrofit Kit	YJ0042

Product Reference Chart

TOOL SPECS	FramePro®325XP	FramePro®701XP	FramePro®751XP
Trigger	Selectable	Sequential	Sequential
Operating Pressure	70-120 psi (4.8-8.3 bar)	70-120 psi (4.8-8.3 bar)	70-120 psi (4.8-8.3 bar)
Air Consumption (60 CPM)	5.2 scfm	10 scfm	11 scfm
Air Inlet	3/8" NPT	3/8" NPT	3/8" NPT
Weight	7.9 lbs (3.58 kg)	8 lbs (3.62 kg)	8.4 lbs (3.8 kg)
Height	11.9" (302 mm)	13.25" (337 mm)	14.25" (362 mm)
Length	17.3" (440 mm)	15.13" (384 mm)	15.13" (384 mm)
Width	4.5" (114 mm)	4.17" (106 mm)	4.17" (106 mm)
Main Body Material	Aluminum	Aluminum	Aluminum
Warranty	5 yrs	5 yrs	5 yrs
FASTENER SPECS	Fasteners are located on pages 39-40		
Range	2"-3 1/4"	2"-3 1/2"	2"-3 1/2"
Shank	.113"-.148"	.113"-.148"	.113"-.148"
Capacity	83	70	70
Angle/Collation	34° Angled Tape Strip	34° Angled Tape Strip	34° Angled Tape Strip
Series	GC, GE, HC, HE, HF, KC ProHead G5, G6, H5, H6, K5, K6	GC, GE, HC, HE, HF, KC ProHead G5, G6, H5, H6, K5, K6	GC, GE, HC, HE, HF, KC, LC ProHead G5, G6, H5, H6, K5, K6
TOOL FEATURES			
Depth-of-Drive	Yes, Tool-Free	Yes, Tool-Free	Yes, Tool-Free
Rafter Hook	Yes	Yes	Yes
Dry Fire Lockout	Yes	Yes	Yes

FramePro®325FRHXP

3/4" FULL ROUND HEAD FRAMING NAILER

ITEM #4H0101N

20°



Features

- Patented TrueDrive magazine reduces jams and misfeeds
- Effective internal design means less wear and tear on the compressor
- Claw-like toenail safety
- Fits easily between studs and joists

FramePro®752XP

3/2" FULL ROUND HEAD FRAMING NAILER

ITEM #2F0103N

20°



Features

- 20° in-line magazine provides excellent maneuverability and line of sight
- Simple two-step loading
- Claw-like toenail safety
- Fits easily between studs and joists

FramePro®702XP

3/2" FULL ROUND HEAD FRAMING NAILER

ITEM #2K0103N

20°

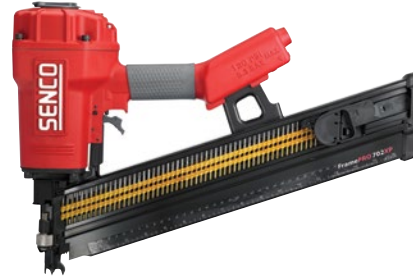

Features

- 20° in-line magazine provides excellent maneuverability and line of sight
- Simple two-step loading
- Claw-like toenail safety
- Fits easily between studs and joists

Product Reference Chart

TOOL SPECS	FramePro®325FRHXP	FramePro®702XP	FramePro®752XP
Trigger	Selectable	Sequential	Sequential
Operating Pressure	70-120 psi (4.8-8.3 bar)	70-120 psi (4.8-8.3 bar)	70-120 psi (4.8-8.3 bar)
Air Consumption (60 CPM)	5.2 scfm	10 scfm	11 scfm
Air Inlet	3/8" NPT	3/8" NPT	3/8" NPT
Weight	7.9 lbs (3.58 kg)	8.4 lbs (3.8 kg)	8.7 lbs (3.97 kg)
Height	11.9" (302 mm)	13.25" (337 mm)	14.25" (362 mm)
Length	17.3" (440 mm)	20" (508 mm)	20" (508 mm)
Width	4.5" (114 mm)	4.17" (106 mm)	4.17" (106 mm)
Main Body Material	Aluminum	Aluminum	Aluminum
Warranty	5 yrs	5 yrs	5 yrs
FASTENER SPECS	Fasteners are located on page 41		
Range	2"-3 1/4"	2"-3 1/2"	2"-3 1/2"
Shank	.113"-.148"	.113"-.148"	.120"-.162"
Capacity	64	60	60
Angle/Collation	20° Angled Plastic Strip	20° Angled Plastic Glued Strip	20° Angled Plastic Strip
Series	GD, GL, HD, HL, HK, KD, KL, MD	GD, GL, HD, HL, KD, MD	GD, GL, HD, HL, KD, MD
TOOL FEATURES			
Depth-of-Drive	Yes, Tool-Free	Yes- Tool Free	Yes, Tool-Free
Rafter Hook	Yes	Yes	Yes
Dry Fire Lockout	Yes	Yes	Yes

SCN60XP

2¾" COIL NAILER

ITEM #520101N



15°

Features

- High load capacity
- EZ-Load design saves time
- Fast cycle time increases productivity
- Lightweight for comfortable all-day use

SCN65XP

3½" COIL NAILER

ITEM #540101N - FLAT SAFETY; 540104N - TOENAIL SAFETY



15°

Features

- High load capacity
- EZ-Load design saves time
- Fast cycle time increases productivity
- Light and fast for greater productivity

Product Reference Chart

TOOL SPECS	SCN60XP	SCN65XP
Trigger	Contact	Contact
Operating Pressure	70-120 psi (4.8-8.3 bar)	70-120 psi (4.8-8.3 bar)
Air Consumption (60 CPM)	8.29 scfm	9.54 scfm
Air Inlet	¾" NPT	¾" NPT
Weight	7.5 lbs (3.4 kg)	8 lbs (3.6 kg)
Height	12.38" (314 mm)	14.1" (359 mm)
Length	12.88" (327 mm)	12.88" (327 mm)
Width	5.38" (137 mm)	5.38" (137 mm)
Main Body Material	Aluminum	Aluminum
Warranty	5 yrs	5 yrs
FASTENER SPECS	Fasteners are located on pages 42-44	
Range	2"-2¾"	2"-3½"
Shank	.099"-.113"	.099"-.131"
Capacity	250-275	225-275
Angle/Collation	15° Flat Wire Welded Coil	15° Flat Wire Welded Coil
Series	BK, BL, BT, GD, GL, HR	BJ, BK, BL, BT, GD, GL, HD, HK, HL, KD
TOOL FEATURES		
Depth-of-Drive	Yes, Tool-Free	Yes, Tool-Free
Rafter Hook	No	No
Dry Fire Lockout	No	No

JoistPro™150XP

1½" METAL CONNECTOR NAILER

ITEM #7L0001N



34°

Features

- Patented nosepiece design exposes nail tip for accurate nail placement into pre-punched metal connector holes
- Powerful enough to drive through engineered lumber
- Lightweight and well balanced

JoistPro™250XP

1½"-2½" METAL CONNECTOR NAILER

ITEM #6K0001N



34°

Features

- Nosepiece probe locates metal connector holes, providing accurate nail placement
- Powerful enough to drive through engineered lumber
- Lightweight and well balanced

Mini Hand Nailer

2"-3½" BULK NAILER

ITEM #PC1195



Features

- Compact and powerful enough to drive 2"-3½" bulk nails
- Magnetic nose holds nail in place for safe, accurate placement
- Ultra-light at just 1 pound

A20 Hand Nailer

2"-7" BULK NAILER

ITEM #PC0781



Features

- Drives bulk nails from 2"-7"
- Soft rubber palm pad for comfortable grip
- Magnetic nose holds nail in place for safe, accurate placement
- Includes leather strap for comfort

Product Reference Chart

TOOL SPECS	JoistPro™150XP	JoistPro™250XP	Mini Hand Nailer	A20 Hand Nailer
Trigger	Sequential	Sequential	—	—
Operating Pressure	70-120 psi (4.8-8.3 bar)	70-120 psi (4.8-8.3 bar)	60-110 psi (4-7.6 bar)	50-125 psi (3.5-8.4 bar)
Air Consumption (60 CPM)	2.3 scfm	4.1 scfm	2-4 scfm	2-4 scfm
Air Inlet	¼" NPT	¼" NPT	¼" NPT	⅜" NPT
Weight	4.6 lbs (2.08 kg)	5.9 lbs (2.68 kg)	1 lb (.45 kg)	2.4 lbs (1.1 kg)
Height	11.97" (302 mm)	14.1" (359 mm)	4" (101 mm)	5.8" (122 mm)
Length	10.35" (263 mm)	13.8" (350 mm)	2.75" (70 mm)	4" (101 mm)
Width	4.0" (100 mm)	4.3" (110 mm)	2" (55.6 mm)	3.25" (83 mm)
Main Body Material	Magnesium	Magnesium	Aluminum	Aluminum
Warranty	5 yrs	5 yrs	1 yr	1 yr
FASTENER SPECS	Fasteners are located on page 45			
Range	1½"	1½"-2½"	Bulk nails from 2"-3½"	Bulk nails from 2"-3½" up to 7" with opt. guide tips
Shank	.131"-.148"	.131"-.162"	—	.113"-.148"
Capacity	30	20	1	1
Angle/Collation	34° Paper Tape Strip	34° Paper Tape Strip	—	—
Series	KJ, MD	KJ, MD, ND	—	—
TOOL FEATURES				
Depth-of-Drive	No	Yes	—	—
Rafter Hook	Yes	Yes	—	—
Dry Fire Lockout	Yes	Yes	—	—

SCP40XP

1½" STANDARD PRESSURE PNEUMATIC CONCRETE & STEEL PINNER

ITEM #7J0001N

0°



Features

- 10 times faster than powder-actuated systems
- No licensing required to operate
- Works with conventional air compressors, hoses and fittings
- Operates at extreme temperatures and altitudes

PS20XP

1" WIDE CROWN, 2" HEAVY WIRE STAPLER

ITEM #9W0001N

16_{GA}



Features

- Enhanced EZ-Clear™ latch allows for quick access to clear fasteners
- Updated aggressive locking feature provides superior holding power for complete control of the fastener, offering pinpoint accuracy and unrivaled driveability
- New drive track design eliminates movement of the staple, enhancing overall drive performance and virtually eliminating fastener jams, skipping and misfires

PS15XP

1" WIDE CROWN, 1½" HEAVY WIRE STAPLER

ITEM #9T0001N

16_{GA}



Features

- Enhanced EZ-Clear™ latch allows for quick access to clear fasteners and a new locking feature offers pinpoint accuracy and unrivaled driveability
- Updated drive track eliminates staple movement, virtually eliminating jams
- Robust firing valve design makes the tool fast, powerful and efficient
- Positive-locking adjustable depth-of-drive ensures consistently flush drives

Concrete Pinner

Plaster, stucco & building wrap fastening attachment

	Fits Tools	Range	ITEM #	
SENCO	SCP40XP	1¼"	NPC035	 Magnetic washer nosepiece

Galvanized Metal Washer

ITEM #	Diameter	Box Count	Fits SCP40XP, GT40CP
SWM125B	1¼"	1M	.109" Dia. Concrete Pins



Feed System Retrofit Kit (Sold Separately)

Updated feed system option

CONVERTS	ITEM #
WC150 to PS15XP	YJ0044

Product Reference Chart

TOOL SPECS	SCP40XP	PS15XP	PS20XP
Trigger	Selectable	Contact	Contact
Operating Pressure	80-120 psi (5.5-8.3 bar)	70-120 psi (4.8-8.3 bar)	70-120 psi (4.8-8.3 bar)
Air Consumption (60 CPM)	5.2 scfm	3.18 scfm	3.45 scfm
Air Inlet	¾" NPT	¾" NPT	¾" NPT
Weight	7.1 lbs (3.2 kg)	5.5 lbs (2.5 kg)	5.5 lbs (2.5 kg)
Height	12.22" (310 mm)	9" (229 mm)	10" (254 mm)
Length	18.2" (462 mm)	15.25" (387 mm)	15.25" (387 mm)
Width	4.5" (114.4 mm)	5.5 lbs (2.5 kg)	3.5" (89 mm)
Main Body Material	Aluminum	Aluminum	Aluminum
Warranty	5 yrs	5 yrs	5 yrs
FASTENER SPECS	Fasteners are located on pages 45-46		
Shank/Crown	.109"/.118" Shanks	1" Crown	1" Crown
Range	½"-1½"	⅝"-1½"	⅞"-2"
Capacity	42	160	160
Angle/Collation	Straight Plastic Collated Strip	Taped and taped glued	Straight Glued and Taped Strip
Series	W3	P	P
TOOL FEATURES			
Depth-of-Drive	No	Yes, Tool-Free	Yes, Tool-Free
Belt Hook	No	Yes	Yes
Dry Fire Lockout	Yes	No	No

SNS41

7/16" CROWN, 2" HEAVY WIRE STAPLER

ITEM #3L0003N

17_{GA} 16_{GA}



Features

- Durable construction minimizes downtime and operating costs
- EZ-Clear™ latch virtually eliminates downtime caused by fastener jams
- Fast, multidirectional stitching

SQS55XP

7/16" CROWN, 2 1/2" HEAVY WIRE STAPLER

ITEM #660101N

15_{GA}



Features

- Fast — up to 15 staples per second
- EZ-Clear™ latch virtually eliminates downtime caused by fastener jams
- Rugged dependability

NS20XP

7/16" CROWN, 2" HEAVY WIRE STAPLER

ITEM #9X0001N

16_{GA} 17_{GA}



Features

- 15% more powerful than all other construction staplers in its class
- Enhanced EZ-Clear™ latch allows for quick access to clear fasteners
- Updated aggressive locking feature
- New drive track design eliminates movement of the staple

Vinyl Siding Attachment (Sold Separately)

Converts NS20XP into a vinyl siding stapler

Fits Tools	ITEM #
NS20XP	HC0788

Block-out Kit (Sold Separately)

For NS20XP Heavy Wire Stapler

Fits Tools	ITEM #
NS20XP	YK0887

Product Reference Chart

TOOL SPECS	SNS41	NS20XP	SQS55XP
Trigger	Contact	Contact	Contact
Operating Pressure	80–120 psi (5.5–8.3 bar)	70–120 psi (4.8–8.3 bar)	80–120 psi (5.5–8.3 bar)
Air Consumption (60 CPM)	5.4 scfm	3.5 scfm	6.54 scfm
Air Inlet	3/8" NPT	3/8" NPT	3/8" NPT
Weight	4.6 lbs (2.1 kg)	5.1 lbs (2.3 kg)	5.9 lbs (2.7 kg)
Height	10.75" (273 mm)	11" (279 mm)	12" (305 mm)
Length	15" (381 mm)	15" (381 mm)	14.38" (365 mm)
Width	3.4" (86 mm)	3.5" (89 mm)	3.6" (92 mm)
Main Body Material	Aluminum	Aluminum	Aluminum
Warranty	5 yrs	5 yrs	5 yrs
FASTENER SPECS	Fasteners are located on pages 46–47		
Crown	7/16"	7/16"	7/16"
Range	1"–2"	1"–2"	1 1/4"–2 1/2"
Capacity	160	160	130
Angle/Collation	Straight Glued and Taped Strip	Straight Glued and Taped Strip	Straight Glued and Taped Strip
Series	N, O	N, O	Q
TOOL FEATURES			
Depth-of-Drive	Yes, Tool-Required	Yes, Tool-Free	Yes, Tool-Required
Belt Hook	No	Yes	No
Dry Fire Lockout	No	No	No

FRAMING, SHEATHING & SUBFLOOR FASTENERS

34° ProHead® Smooth Paper Tape Nails

Framing, sheathing, subfloor, decks, trusses and pallets

Length	Point	Finish	Coating	Collation	Box Count	Item Code
2 3/8" x .113"	Diamond	Bright	Sencote	34° Paper Tape Strip	2.5M	G524APBXN
3" x .120"	Diamond	Bright	Sencote	34° Paper Tape Strip	2.5M	H527APBXN
3 1/4" x .120"	Diamond	Bright	Sencote	34° Paper Tape Strip	2.5M	H528APBXN
2 1/2" x .131"	Diamond	Bright	Sencote	34° Paper Tape Strip	2M	K525APBXN
3" x .131"	Diamond	Bright	Sencote	34° Paper Tape Strip	2.5M	K527APBXN
3" x .131"	Diamond	Bright	Sencote	34° Paper Tape Strip	0.5M	K527APBXR
3 1/4" x .131"	Diamond	Bright	Sencote	34° Paper Tape Strip	2.5M	K528APBXN
3 1/4" x .131"	Diamond	Bright	Sencote	34° Paper Tape Strip	0.5M	K528APBXR
3 1/2" x .131"	Diamond	Bright	Sencote	34° Paper Tape Strip	2.5M	K529APBXN
2 3/8" x .113"	Diamond	Hot Dip	Sencote	34° Paper Tape Strip	2.5M	G524ASBXN
3" x .131"	Diamond	Hot Dip	Sencote	34° Paper Tape Strip	2.5M	K527ASBXN
3 1/4" x .131"	Diamond	Hot Dip	Sencote	34° Paper Tape Strip	2.5M	K528ASBXN

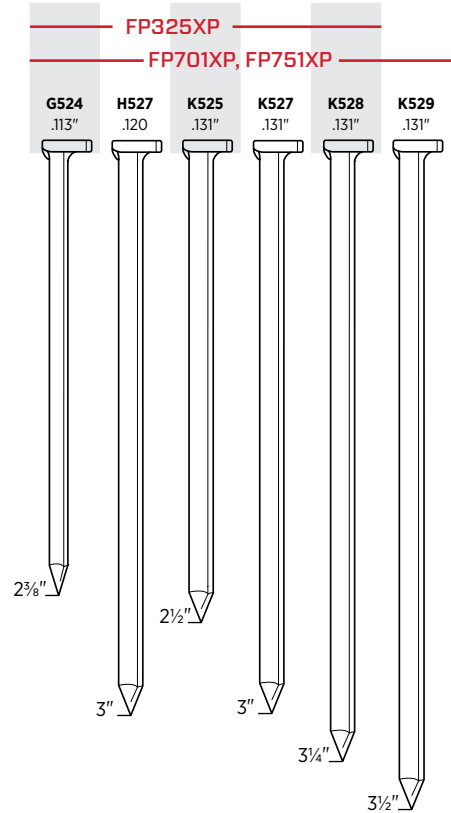

34° ProHead® Ring Paper Tape Nails

Framing, sheathing, subfloor, decks, trusses and pallets

Length	Point	Finish	Coating	Collation	Box Count	Item Code
2 3/8" x .113"	Diamond	Bright	Sencote	34° Paper Tape Strip	2.5M	G624APBXN
3" x .120"	Diamond	Bright	Sencote	34° Paper Tape Strip	2.5M	H627APBXN
3 1/4" x .120"	Diamond	Bright	Sencote	34° Paper Tape Strip	2.5M	H628APBXN
2" x .113"	Diamond	Hot Dip	Sencote	34° Paper Tape Strip	2.5M	G621ASBXN
2 3/8" x .113"	Diamond	Hot Dip	Sencote	34° Paper Tape Strip	2.5M	G624ASBXN
3" x .120"	Diamond	Hot Dip	Sencote	34° Paper Tape Strip	2.5M	H627ASBXN
3" x .131"	Diamond	Hot Dip	Sencote	34° Paper Tape Strip	2.5M	K627ASBXN
3 1/4" x .131"	Diamond	Hot Dip	Sencote	34° Paper Tape Strip	2.5M	K628ASBXN
3 1/2" x .131"	Diamond	Hot Dip	Sencote	34° Paper Tape Strip	2.5M	K629ASBXN

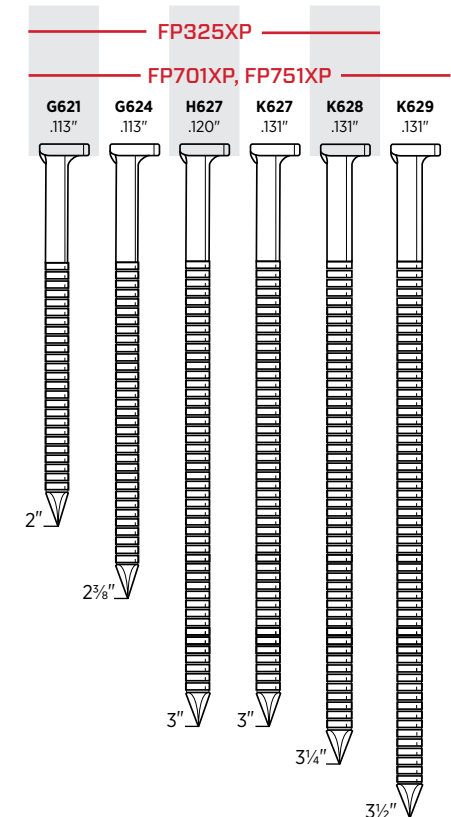

FRAMING, SHEATHING & SUBFLOOR FASTENERS

34° Smooth Shank Paper Tape Collated Nails

Framing, sheathing, subfloor, decks, trusses and pallets						
Length	Point	Finish	Coating	Collation	Box Count	Item Code
2¼" x .113"	Diamond	Bt. Hardened	Plain	34° Paper Tape Strip	1M	GC23AHAK
2" x .113"	Diamond	Bright	Sencote	34° Paper Tape Strip	2.5M	GC21APBX
2¾" x .113"	Diamond	Bright	Sencote	34° Paper Tape Strip	2.5M	GC24APBX
2½" x .113"	Diamond	Bright	Sencote	34° Paper Tape Strip	2.5M	GC25APBX
3" x .120"	Diamond	Bright	Sencote	34° Paper Tape Strip	2.5M	HC27APBX
3¼" x .120"	Diamond	Bright	Sencote	34° Paper Tape Strip	2.5M	HC28APBX
3" x .131"	Diamond	Bright	Sencote	34° Paper Tape Strip	2.5M	KC27APBX
3¼" x .131"	Diamond	Bright	Sencote	34° Paper Tape Strip	2.5M	KC28APBX
3½" x .131"	Diamond	Bright	Sencote	34° Paper Tape Strip	2.5M	KC29APBX
3½" x .135"	Diamond	Bright	Sencote	34° Paper Tape Strip	2.5M	LC29APBX
4" x .131"	Diamond	Bright	Sencote	34° Paper Tape Strip	2.5M	KC31APBX*
2¾" x .113"	Diamond	Hot Dip	Sencote	34° Paper Tape Strip	2.5M	GC24ASBX
3" x .120"	Diamond	Hot Dip	Sencote	34° Paper Tape Strip	2.5M	HC27ASBX
3" x .131"	Diamond	Hot Dip	Sencote	34° Paper Tape Strip	2.5M	KC27ASBX
3¼" x .131"	Diamond	Hot Dip	Sencote	34° Paper Tape Strip	2.5M	KC28ASBX
3½" x .131"	Diamond	Hot Dip	Sencote	34° Paper Tape Strip	2.5M	KC29ASBX
3" x .131"	Diamond	Stainless 304	Sencote	34° Paper Tape Strip	1M	KC27AGBK
3¼" x .131"	Diamond	Stainless 304	Sencote	34° Paper Tape Strip	1M	KC28AGBK

*FramePro®751XP can drive 4 inch nails when fitted with the YJ0042 kit

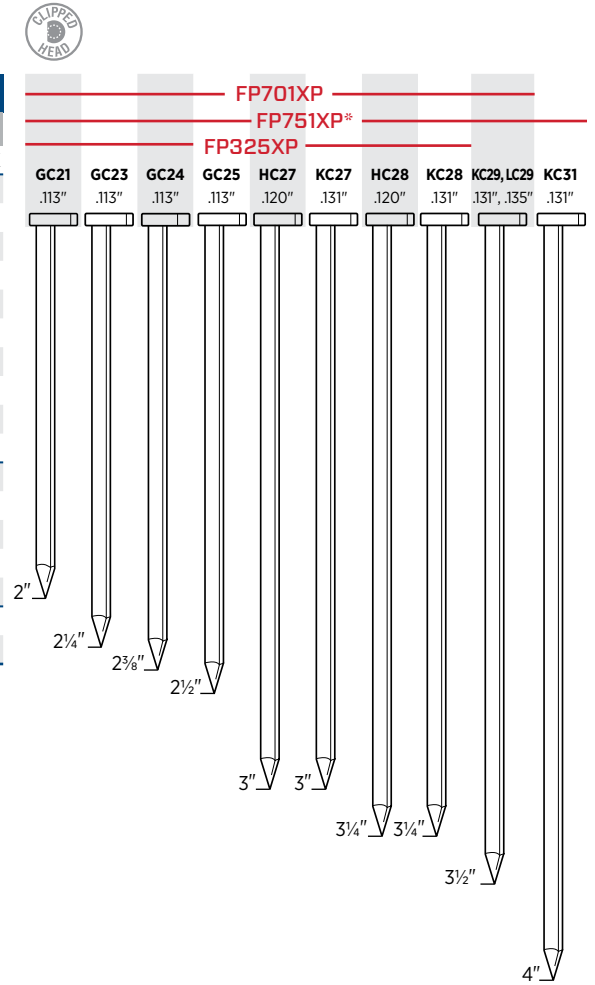

34° Ring Shank Paper Tape Collated Nails

Framing, sheathing, subfloor, decks, trusses and pallets						
Length	Point	Finish	Coating	Collation	Box Count	Item Code
2" x .113"	Diamond	Bright	Plain	34° Paper Tape Strip	2.5M	GE21APAX
2¾" x .113"	Diamond	Bright	Sencote	34° Paper Tape Strip	2.5M	GE24APBX
2" x .113"	Diamond	Hot Dip	Sencote	34° Paper Tape Strip	2.5M	GE21ASBX
2¾" x .113"	Diamond	Hot Dip	Sencote	34° Paper Tape Strip	2.5M	GE24ASBX
3" x .120"	Diamond	Hot Dip	Sencote	34° Paper Tape Strip	2.5M	HE27ASBX
2¾" x .113"	Diamond	Stainless 304	Sencote	34° Paper Tape Strip	1M	GE24AGBK

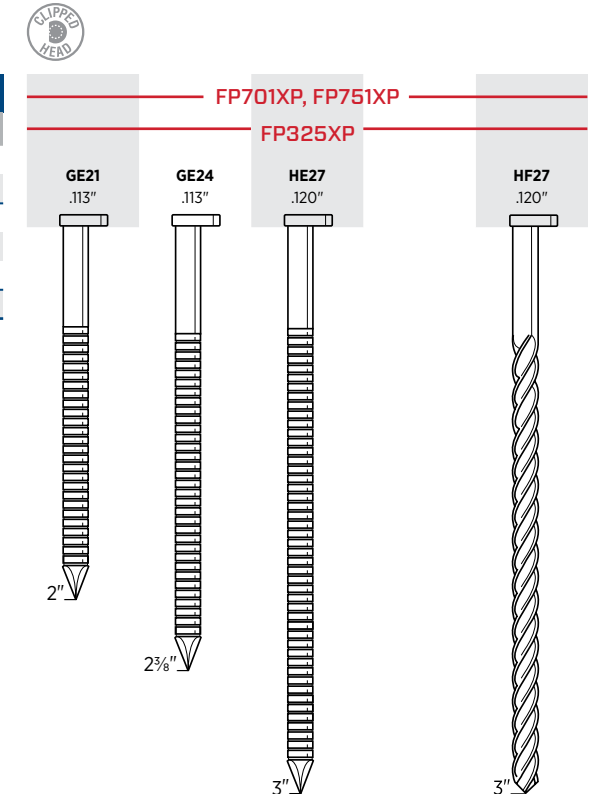

34° Screw Shank Paper Tape Collated Nails

Framing, sheathing, subfloor, decks, trusses and pallets						
Length	Point	Finish	Coating	Collation	Box Count	Item Code
3" x .120"	Chisel	Bright	Plain	34° Paper Tape Strip	3.1M	HF27EPAK
3" x .120"	Chisel	Bright	Sencote	34° Paper Tape Strip	1M	HF27EDB

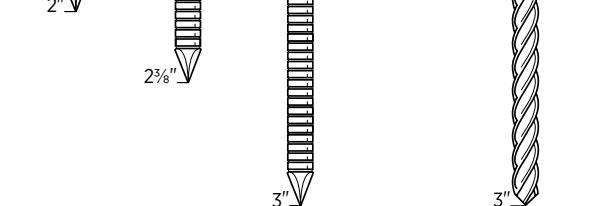

FRAMING, SHEATHING & SUBFLOOR FASTENERS

20° Smooth Shank Plastic Collated Nails

Framing, sheathing, subfloor, decks, trusses and pallets						
Length	Point	Finish	Coating	Collation	Box Count	Item Code
2 3/8" x .113"	Diamond	Bright	Sencote	20° Plastic Strip	5M	GD24APBSN
2 1/2" x .113"	Diamond	Bright	Sencote	20° Plastic Strip	5M	GD25APBSN
2 1/2" x .131"	Diamond	Bright	Sencote	20° Plastic Strip	4M	KD25APBSN
3" x .120"	Diamond	Bright	Sencote	20° Plastic Strip	4M	HD27APBSN
3" x .131"	Diamond	Bright	Sencote	20° Plastic Strip	4M	KD27APBSN
3" x .148"	Diamond	Bright	Sencote	20° Plastic Strip	4M	MD27APBSN
3 1/4" x .131"	Diamond	Bright	Sencote	20° Plastic Strip	4M	KD28APBSN
3 1/4" x .148"	Diamond	Bright	Sencote	20° Plastic Strip	4M	MD28APBSN
3 1/2" x .131"	Diamond	Bright	Sencote	20° Plastic Strip	4M	KD29APBSN
2 3/8" x .113"	Diamond	Hot Dip	Sencote	20° Plastic Strip	2.5M	GD24ASBS
2 1/2" x .113"	Diamond	Galv	Sencote	20° Plastic Strip	5M	GD25AABS
2 1/2" x .120"	Diamond	Exterior	Sencote	20° Plastic Strip	2.3M	HJ25ADBS*
2 1/2" x .131"	Diamond	Galv	Sencote	20° Plastic Strip	2.5M	KD25AABS
3" x .131"	Diamond	Hot Dip	Sencote	20° Plastic Strip	2.5M	KD27ASBS
3 1/4" x .131"	Diamond	Hot Dip	Sencote	20° Plastic Strip	2.5M	KD28ASBS
3 1/2" x .131"	Diamond	Hot Dip	Sencote	20° Plastic Strip	2.5M	KD29ASBS
3 1/4" x .131"	Diamond	Stainless 304	Sencote	20° Plastic Strip	1M	KD28AGBS

*Roof tile nails, drive with FramePro® 725XP or SN952XP

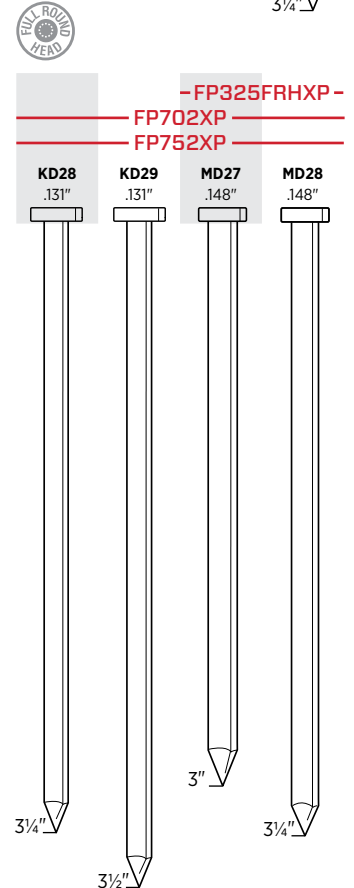
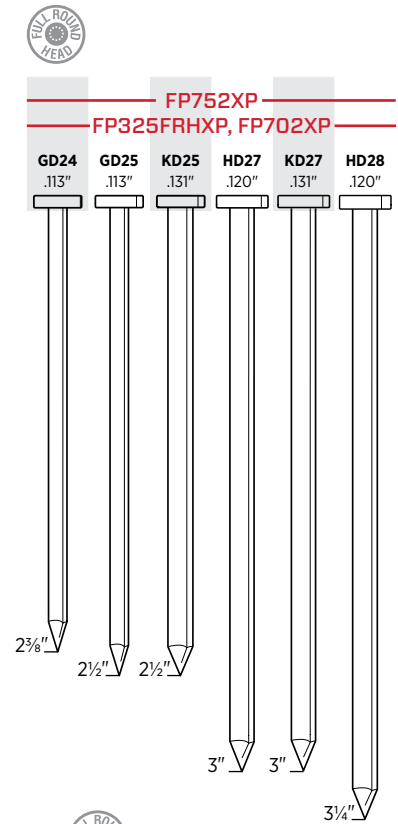

FRAMING, SHEATHING & SUBFLOOR FASTENERS

20° Ring Shank Plastic Collated Nails

Framing, sheathing, subfloor, decks, trusses and pallets						
Length	Point	Finish	Coating	Collation	Box Count	Item Code
2" x .113"	Diamond	Bright	Sencote	20° Plastic Strip	5M	GL21APBSN
2 3/8" x .113"	Diamond	Bright	Sencote	20° Plastic Strip	5M	GL24APBSN
2" x .113"	Diamond	Hot Dip	Sencote	20° Plastic Strip	2.5M	GL21ASBS
2 3/8" x .113"	Diamond	Galv	Sencote	20° Plastic Strip	5M	GL24AABSN
2 3/8" x .113"	Diamond	Hot Dip	Sencote	20° Plastic Strip	2.5M	GL24ASBS
3" x .120"	Diamond	Hot Dip	Sencote	20° Plastic Strip	2.5M	HL27ASBS
2 3/8" x .113"	Diamond	Stainless 304	Sencote	20° Plastic Strip	1M	GL24AGBS
3" x .120"	Diamond	Stainless 304	Sencote	20° Plastic Strip	1M	HL27AGBS

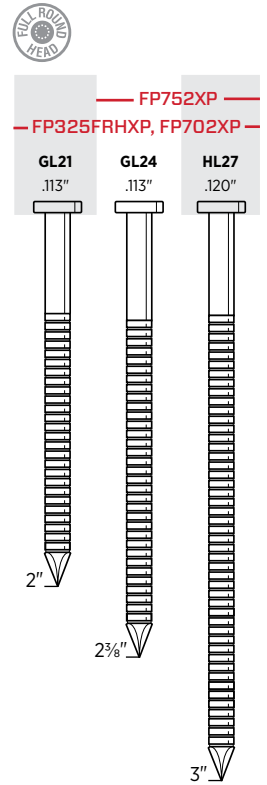

15° Ring Shank Subflooring Nails

Superior fastening in subfloor applications						
Length	Point	Finish	Coating	Collation	Box Count	Item Code
2" x .099"	Diamond	Bright Basic	Sencote	15° Flat Wire Welded Coil	6.6M	BT21APBF
2 3/8" x .113"	Diamond	Bright Basic	Sencote	15° Flat Wire Welded Coil	4M	GT24APBF
2 1/2" x .131"	Diamond	Bright Basic	Sencote	15° Flat Wire Welded Coil	4M	KT25APBF

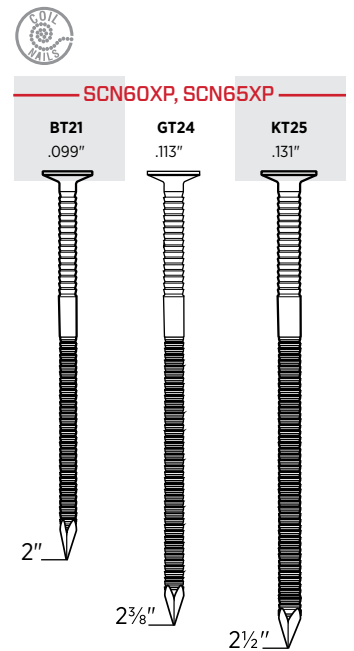

Subfloor and Sheathing Coil Nails

- Superior fastening in floor applications
- Tested and proven to reduce squeaky subfloors, uneven surfaces, and raised nail heads
- Unique double rings shank design reduces the potential of nails backing out, one of the most common flooring problems

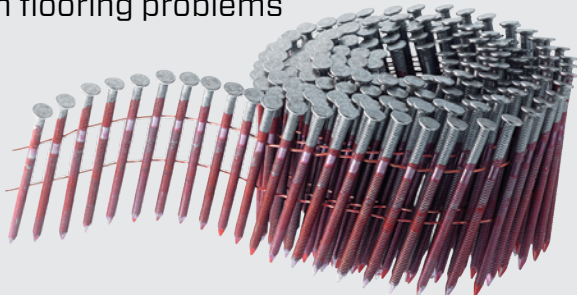

FRAMING, SHEATHING & SUBFLOOR FASTENERS

15° Smooth Shank Coil Nails

Framing, sheathing, pallets, subfloor, decks and trusses

Length	Point	Finish	Coating	Collation	Box Count	Item Code
2" x .113"	Diamond	Bright	Sencote	15° Flat Wire Welded Coil	6M	GD21APBF
2½" x .113"	Diamond	Bright	Sencote	15° Flat Wire Welded Coil	6M	GD25APBF
2½" x .131"	Diamond	Bright	Sencote	15° Flat Wire Welded Coil	3.6M	KD25APBF
3" x .120"	Diamond	Bright	Sencote	15° Flat Wire Welded Coil	4M	HD27APBF
3" x .131"	Diamond	Bright	Sencote	15° Flat Wire Welded Coil	3.6M	KD27APBF
3¼" x .131"	Diamond	Bright	Sencote	15° Flat Wire Welded Coil	3.6M	KD28APBF
3½" x .131"	Diamond	Bright	Sencote	15° Flat Wire Welded Coil	3.6M	KD29APBF
5" x .148"	Diamond	Bright	Sencote	15° Flat Wire Welded Coil	1.8M	MD34APBF
2" x .113"	Diamond	Galv	Sencote	15° Flat Wire Welded Coil	6M	GD21AABF
2½" x .113"	Diamond	Galv	Sencote	15° Flat Wire Welded Coil	6M	GD25AABF
3" x .131"	Diamond	Hot Dip	Sencote	15° Flat Wire Welded Coil	2.4M	KD27ASBF
3¼" x .131"	Diamond	Hot Dip	Sencote	15° Flat Wire Welded Coil	2.4M	KD28ASBF

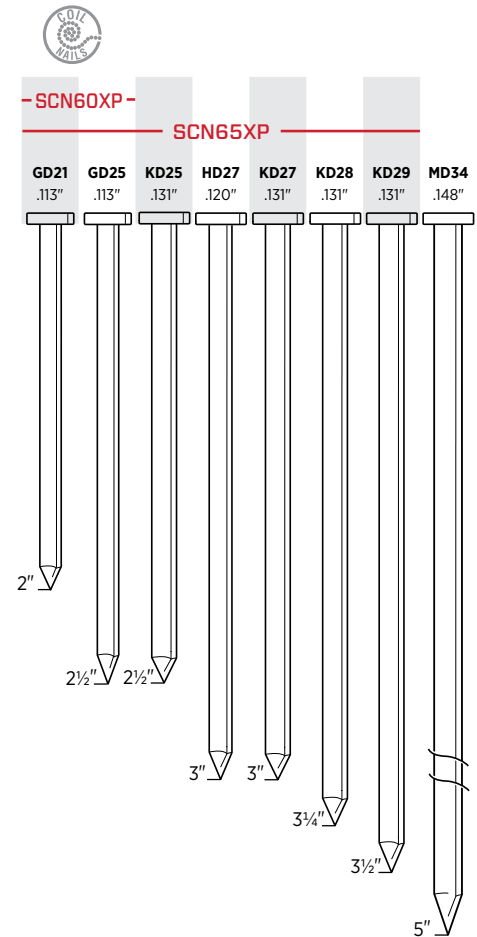

15° Ring Shank Coil Nails

Framing, sheathing, pallets, subfloor, decks and trusses

Length	Point	Finish	Coating	Collation	Box Count	Item Code
2" x .099"	Diamond	Bright	Sencote	15° Flat Wire Welded Coil	6.6M	BL21APBF
2" x .099"	Diamond	Bright	Sencote	15° Flat Wire Welded Coil	6.6M	BT21APBF
2" x .113"	Diamond	Bright	Sencote	15° Flat Wire Welded Coil	6M	GL21APBF
2¾" x .113"	Diamond	Bright	Sencote	15° Flat Wire Welded Coil	6M	GL24APBF
2¼" x .099"	Diamond	Galv	Sencote	15° Flat Wire Welded Coil	6.6M	BE23AABF
2¾" x .113"	Diamond	Hot Dip	Sencote	15° Flat Wire Welded Coil	2.7M	GL24ASBF
3" x .120"	Diamond	Hot Dip	Sencote	15° Flat Wire Welded Coil	2.4M	HL27ASBF
2¾" x .113"	Diamond	Stainless 304	Sencote	15° Flat Wire Welded Coil	2.7M	GL24AGBF

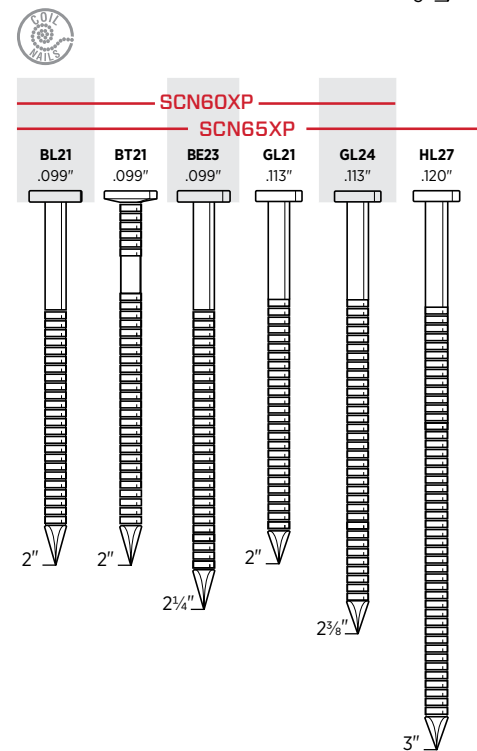

FRAMING, SHEATHING & SUBFLOOR FASTENERS

15° Screw Shank Coil Nails

Framing, sheathing, pallets, subfloor, decks and trusses						
Length	Point	Finish	Coating	Collation	Box Count	Item Code
2" x .099"	Blunt Dia.	Bright	Sencote	15° Flat Wire Welded Coil	9M	BK21BPBFN
2¼" x .099"	Blunt Dia.	Bright	Sencote	15° Flat Wire Welded Coil	9M	BK23BPBFN
2½" x .099"	Blunt Dia.	Bright	Sencote	15° Flat Wire Welded Coil	6M	BK25BPBFN
3" x .120"	Diamond	Bright	Sencote	15° Flat Wire Welded Coil	4M	HK27APBFN

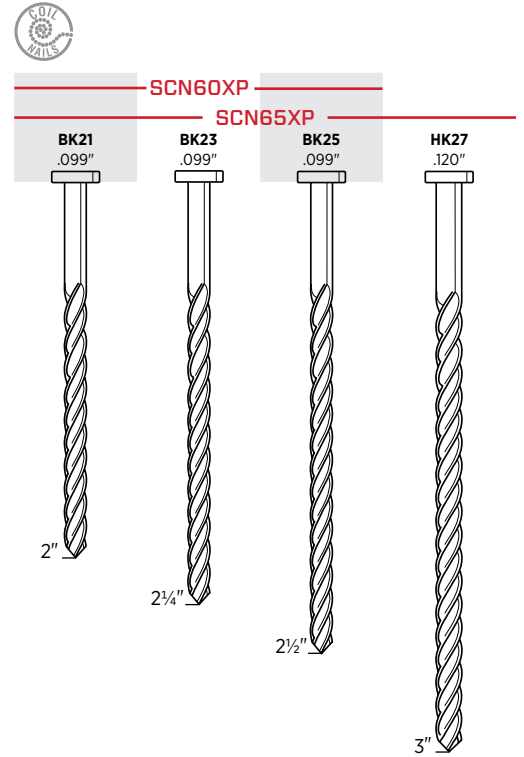

15° Smooth Shank Stiff-Stock Coil Nails

For fastening wood to masonry						
Length	Point	Finish	Coating	Collation	Box Count	Item Code
1½" x .099"	Diamond	Bright	Sencote	15° Flat Wire Welded Coil	3M	MO03011

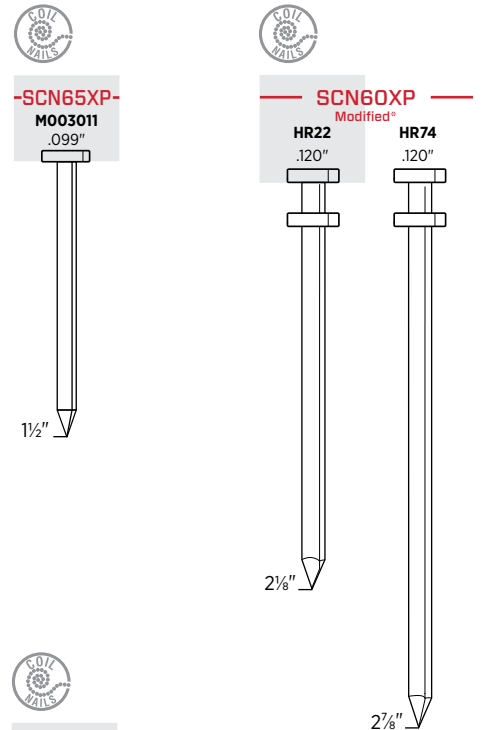

15° Duplex Smooth Shank Coil Nails*

Framing, trusses, crating and concrete forms						
Length	Point	Finish	Coating	Collation	Box Count	Item Code
2½" x .120"	Diamond	Bright	Plain	15° Flat Wire Welded Coil	5.4M	HR22APAF
2¾" x .120"	Diamond	Bright	Plain	15° Flat Wire Welded Coil	3.6M	HR74APAF

*Requires a special-order modified SCN60XP tool (order XA1739)

15° Drywall Ring Shank Bugle Head Coil Nails

For fastening drywall to wood						
Length	Point	Finish	Coating	Collation	Box Count	Item Code
1½" x .099"	Diamond	Galv	Plain	15° Conical Wire Welded Coil	6.4M	BG17AAAQ
1¾" x .099"	Diamond	Galv	Plain	15° Conical Wire Welded Coil	6.4M	BG18AAAQ

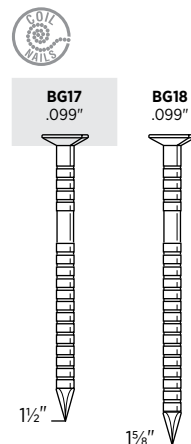

0° Collated Concrete and Steel Pins

For fastening drywall track, wood furring, hat channels, metal washers or ceiling grid to concrete, concrete block and steel

Length	Point	Finish	Coating	Collation	Box Count	Item Code
1/2" x .109"/.118"	Pinched	Zinc Plated	Plain	Straight Plastic Collated Strip	1M	W3050YXS
3/4" x .109"	Pinched	Zinc Plated	Plain	Straight Plastic Collated Strip	1M	W3075YXC
1" x .109"	Pinched	Zinc Plated	Plain	Straight Plastic Collated Strip	1M	W3100YXC
1 1/4" x .109"	Pinched	Zinc Plated	Plain	Straight Plastic Collated Strip	1M	W3125YXC

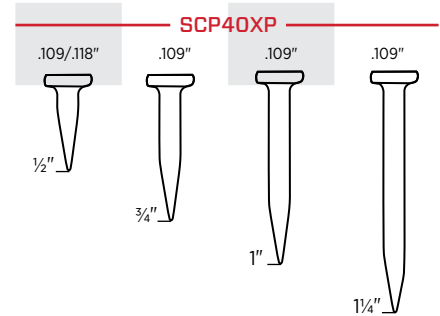

34° Stiff Stock - Medium Carbon Steel Metal Connector Nails

Joist hangers, foundation anchors, seismic and hurricane straps and ties

Length	Point	Finish	Coating	Collation	Box Count	Item Code
1 1/2" x .148"	Diamond	Bright	Plain	34° Paper Tape Strip	2M	MD17AQBDN
2 1/2" x .162"	Diamond	Bright	Plain	34° Paper Tape Strip	1.2M	ND25AQBD
1 1/2" x .148"	Diamond	Hot Dip	Plain	34° Paper Tape Strip	2M	MD17AJBD
2 1/2" x .148"	Diamond	Hot Dip	Plain	34° Paper Tape Strip	1.5M	MD25AJBD

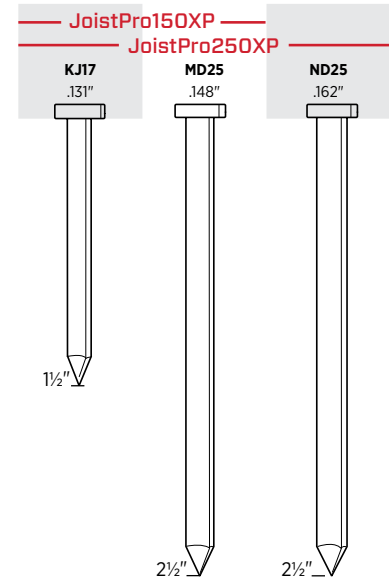

34° Heat Treated Metal Connector Nails

Joist hangers, foundation anchors, seismic and hurricane straps and ties

Length	Point	Finish	Coating	Collation	Box Count	Item Code
1 1/2" x .131"	Diamond	Bright	Plain	34° Paper Tape Strip	2M	KJ17AHBD
2 1/2" x .148"	Diamond	Bright	Plain	34° Paper Tape Strip	1.5M	MD25AHBD
1 1/2" x .131"	Diamond	Hot Dip	Plain	34° Paper Tape Strip	2M	KJ17AEBD

34° Non-Heat Treated Metal Connector Nails

Standard tensile, non-hardened nails for use in joist hangers, foundation anchors, seismic and hurricane straps and ties

Length	Point	Finish	Coating	Collation	Box Count	Item Code
1 1/2" x .131"	Diamond	Bright	Plain	34° Paper Tape Strip	2M	M002261
1 1/2" x .148"	Diamond	Bright	Plain	34° Paper Tape Strip	2M	M002263
2 1/2" x .148"	Diamond	Bright	Plain	34° Paper Tape Strip	1.5M	M002265
1 1/2" x .131"	Diamond	Hot Dip	Plain	34° Paper Tape Strip	2M	M002262
1 1/2" x .148"	Diamond	Hot Dip	Plain	34° Paper Tape Strip	2M	M002264
2 1/2" x .148"	Diamond	Hot Dip	Plain	34° Paper Tape Strip	1.5M	M002266

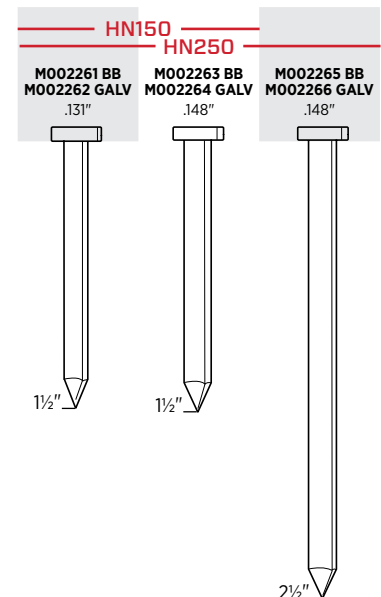

FRAMING, SHEATHING & SUBFLOOR FASTENERS

16^{GA}

1" Crown Heavy Wire Staples

Sheathing, house wrap, composite roofing, roofing felt, corrugated containers, foam insulation board, furniture/cabinet frames and butt joints

Length	Point	Finish	Coating	Collation	Box Count	Item Code
3/8"	Chisel	Galv	Plain	Glued	10M	P06BAA*
1/2"	Chisel	Galv	Sencote	Taped	10M	P08BABT*
5/8"	Chisel	Galv	Sencote	Taped	10M	P10BAB*
5/8"	Divergent	Galv	Sencote	Glued	10M	P10FAB*
5/8"	Chisel	Galv	Coated	Glued	10M	P10BPE*
3/4"	Chisel	Galv	Sencote	Taped	10M	P11BAB
3/4"	Chisel	Galv	Coated	Glued	10M	P11BPE
7/8"	Chisel	Galv	Sencote	Taped	10M	P12BAB
1"	Chisel	Galv	Sencote	Taped	10M	P13BAB
1"	Chisel	Galv	Sencote	Glued	10M	P13BPE
1 1/4"	Chisel	Galv	Sencote	Taped	10M	P15BAB
1 1/4"	Chisel	Galv	Coated	Glued	10M	P15BPE
1 1/2"	Chisel	Galv	Sencote	Taped	10M	P17BAB
1 3/4"	Chisel	Galv	Sencote	Taped	5M	P19BAB
2"	Chisel	Galv	Sencote	Taped	5M	P21BAB
1"	Outside Chisel	Stainless 304	Sencote	Taped	5M	P13BGBN

*Use kit #YK0883 with PS15XP for 3/8"-5/8" staples

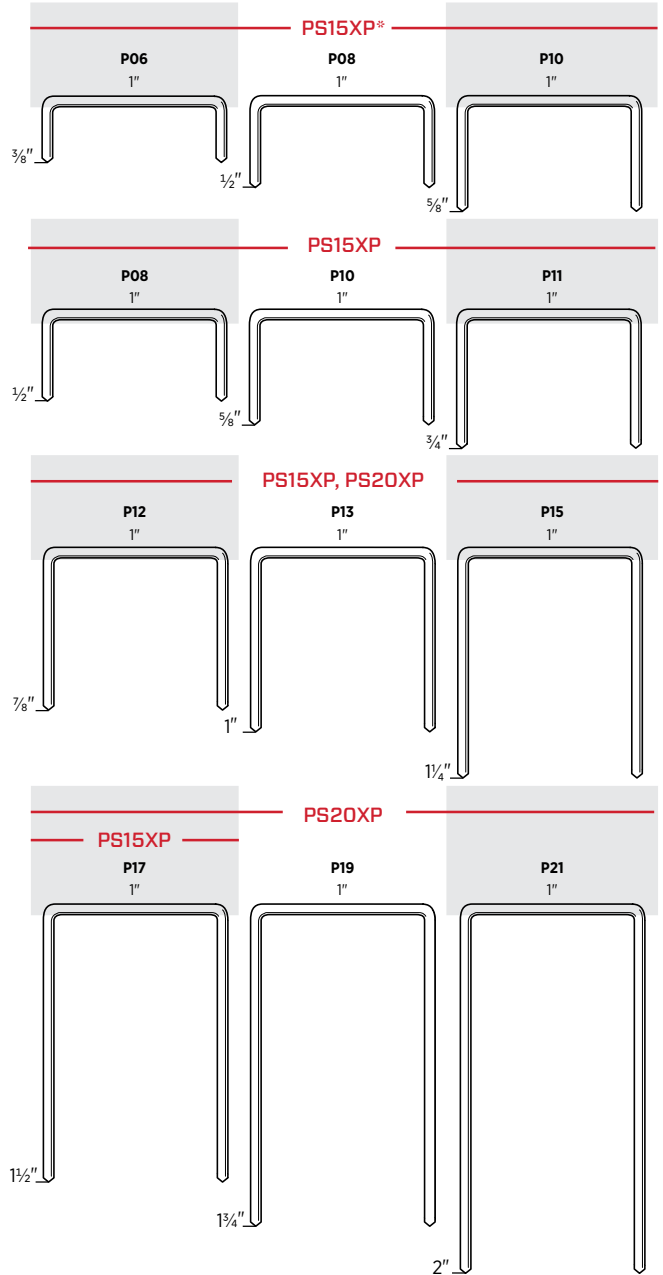

*Use kit #YK0883 with PS15XP for 3/8"-5/8" staples

17^{GA}

7/16" Crown Heavy Wire Staples*

Sheathing, subfloor, furniture frames and crates

Length	Point	Finish	Coating	Collation	Box Count	Item Code
1 1/4"	Chisel	Bright	Sencote	Glued	21.12M	O15BRBBN
1 3/8"	Chisel	Bright	Sencote	Glued	17.6M	O16BRBBN
1 1/2"	Chisel	Bright	Sencote	Glued	17.6M	O17BRBBN
1 5/8"	Chisel	Bright	Sencote	Glued	17.6M	O18BRBBN
1 3/4"	Chisel	Bright	Sencote	Glued	14.08M	O19BRBBN

*Compatible with NS20XP, NS20BXP, SNS200XP, SNS200XP-BST, SNS41 staplers manufactured after 09/2010. SNS44XP and SNS45XP staplers manufactured after 05/2010. For older tools, order upgrade kits SNS41-YK0794, SNS44-YK0793, SNS45-FA0186.

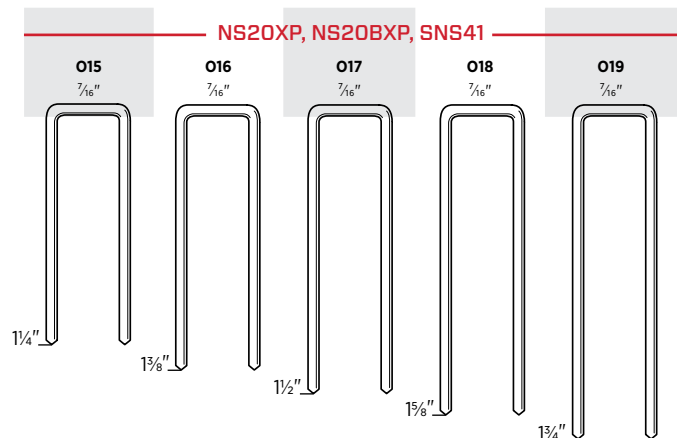

FRAMING, SHEATHING & SUBFLOOR FASTENERS

16^{GA}

1/16" Crown Heavy Wire Staples

Sheathing, soffits, underlayment, lattice, cabinets, casebacks and drawers

Length	Point	Finish	Coating	Collation	Box Count	Item Code
3/4"	Chisel	Bright	Sencote	Glued	5M	N11BRB
1"	Chisel	Bright	Sencote	Glued	5M	N13BRB
1 1/8"	Chisel	Bright	Sencote	Taped	10M	N14BRB
1 1/4"	Chisel	Bright	Sencote	Taped	10M	N15BRB
1 3/8"	Chisel	Bright	Sencote	Taped	10M	N16BRB
1 1/2"	Chisel	Bright	Sencote	Taped	10M	N17BRB
1 5/8"	Chisel	Bright	Sencote	Taped	10M	N18BRB
1 3/4"	Chisel	Bright	Sencote	Taped	10M	N19BRB
2"	Chisel	Bright	Sencote	Taped	10M	N21BRB
1/2"	Chisel	Galv	Sencote	Glued	5M	N08BABN
1/2"	Chisel	Galv*	Sencote	Glued	5M	N08BBBN
1/2"	Diverg	Galv*	Sencote	Glued	5M	N08FBB
5/8"	Chisel	Galv*	Sencote	Glued	5M	N10BAB
3/4"	Chisel	Galv	Sencote	Glued	5M	N11BAB
3/4"	Diverg	Galv*	Sencote	Glued	5M	N11FBB
7/8"	Chisel	Galv	Sencote	Glued	5M	N12BABN
7/8"	Diverg	Galv	Sencote	Glued	5M	N12FABN
1"	Chisel	Galv	Sencote	Glued	5M	N13BAB
1"	Diverg	Galv	Sencote	Glued	5M	N13FAB
1 1/8"	Chisel	Galv	Sencote	Taped	10M	N14BAB
1 1/4"	Chisel	Galv	Sencote	Taped	10M	N15BAB
1 1/4"	Diverg	Galv	Sencote	Glued	10M	N15FAB
1 3/8"	Chisel	Galv	Sencote	Taped	10M	N16BAB
1 1/2"	Chisel	Galv	Sencote	Taped	10M	N17BAB
1 1/2"	Chisel	Galv	Sencote	Glued	10M	N17BPE
1 5/8"	Chisel	Galv	Sencote	Taped	10M	N18BAB
1 3/4"	Chisel	Galv	Sencote	Taped	10M	N19BAB
1 3/4"	Chisel	Galv	Sencote	Glued	10M	N19BPE
2"	Chisel	Galv	Sencote	Taped	10M	N21BAB
2"	Chisel	Galv	Sencote	Glued	10M	N21BPE
1 1/4"	Chisel	Stainless 304	Sencote	Glued	3M	N15BGB
1 1/2"	Chisel	Stainless 304	Sencote	Glued	3M	N17BGB
1 3/4"	Chisel	Stainless 304	Sencote	Glued	3M	N19BGBN
2"	Chisel	Stainless 304	Sencote	Glued	3M	N21BGBN

*Galvanized High-Tensile Steel

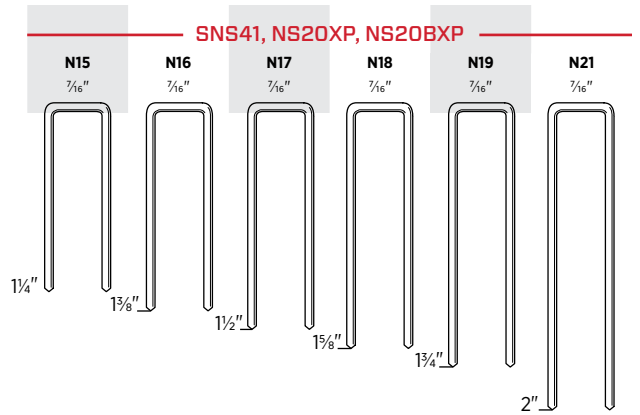
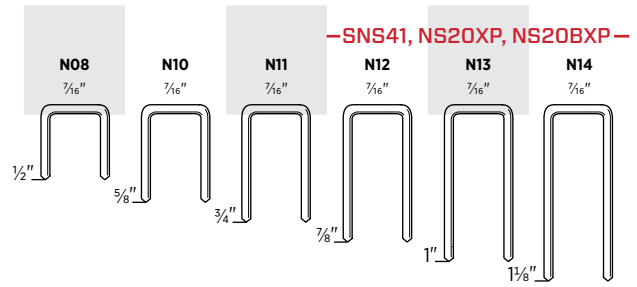

15^{GA}

1/16" Crown Heavy Wire Staples

Framing, sheathing, subflooring, decking, lathing, door and window units, fencing, pallets, crate and box assembly, furring and furniture framing

Length	Point	Finish	Coating	Collation	Box Count	Item Code
1 1/2"	Chisel	Bright	Sencote	Taped	5M	Q17BRB
1 3/4"	Chisel	Bright	Sencote	Taped	5M	Q19BRB
2"	Chisel	Bright	Sencote	Taped	5M	Q21BRB
2 1/4"	Chisel	Bright	Sencote	Taped	5M	Q23BRB
2 1/2"	Chisel	Bright	Sencote	Taped	5M	Q25BRB
1 1/4"	Chisel	Galv	Sencote	Taped	5M	Q15BAB
1 1/2"	Chisel	Galv	Sencote	Taped	5M	Q17BAB
1 3/4"	Chisel	Galv	Sencote	Taped	5M	Q19BAB
2"	Chisel	Galv	Sencote	Taped	5M	Q21BAB
2 1/2"	Chisel	Galv	Sencote	Taped	5M	Q25BAB
1 3/4"	Chisel	Stainless 304	Sencote	Taped	2.2M	Q19BGBN
2 1/2"	Chisel	Stainless 304	Sencote	Taped	1M	Q25BGBN

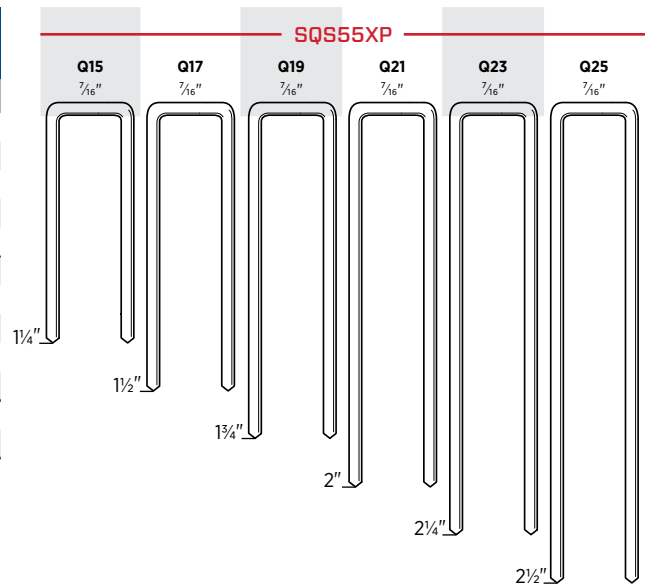

ROOFING, SIDING & FENCING

WE COVER IT ALL

When it comes to roofing applications or installing siding, uptime is everything. SENCO has designed a full line of tools and fasteners to maximize your productivity.

Our RoofPro™445XP with its innovative firing valve uses 5% less air. A bi-metal driver blade increases durability. And our power in, power out feed system is air driven for stability and speed.

APPLICATIONS

SENCO offers a variety of coil nailers and crown staplers with fasteners optimized for different types of shingles, siding, sheathing, and felt underlayment.

FEATURES

- High-strength housings
- Long-lasting wear plates
- Easy, one-handed operation
- Adjustable depth-of-drive



RoofPro™445XP

1¾" COIL NAILER

ITEM #8V0001N

15°



Features

- Innovative firing valve reduces air consumption without compromising power or speed
- Bi-metal driver blade reduces wear and improves durability
- Power in, power out feed system improves speed and delivers consistent drives
- Metal wear plate in nail canister reduces wear and helps improve nail feed
- Adjustable and removable shingle guide

SCN49XP

2½" COIL NAILER

ITEM #5J0001N

15°



Features

- Well balanced and lightweight
- Dual collation allows choice between wire or plastic collation
- High load capacity



RoofPro™445XP

Blows the Roof off the Competition

It doesn't cost a bundle to drive the very best.



Building Code Approved

Professional Performance

Product Reference Chart

TOOL SPECS	RoofPro™445XP	SCN49XP
Trigger	Contact	Selectable
Operating Pressure	70-120 psi (4.8-8.3 bar)	70-120 psi (4.8-8.3 bar)
Air Consumption (60 CPM)	3.86 scfm	3.9 scfm
Air Inlet	¼" NPT	⅜" NPT
Weight	5.2 lbs (2.35 kg)	5.1 lbs (2.31 kg)
Height	10.9" (276 mm)	12" (304 mm)
Length	10.6" (269 mm)	12.25" (314 mm)
Width	4.5" (114 mm)	5.19" (132 mm)
Main Body Material	Aluminum	Magnesium
Warranty	5 yrs	5 yrs
FASTENER SPECS	Fasteners are located on pages 51-52	
Range	¾"-1¼"	1¼"-2½"
Shank	.120"	.082"-.092"
Capacity	120	250-375
Angle/Collation	15° Flat Wire Welded Coil	15° Flat Wire Welded or Plastic Carrier Coil
Series	HJ, M00	ED, EL, SE
TOOL FEATURES		
Depth-of-Drive	Yes, Tool-Free	Yes, Tool-Free
Tool-Free Jam Clearing	Yes	Yes
Adjustable Exhaust	No	Yes

PS15RXP

1" CROWN 1½" ROOFING STAPLER

ITEM #9U0001N

16_{GA}



Features

- Enhanced EZ-Clear™ latch allows for quick access to clear fasteners
- New aggressive locking feature offers pinpoint accuracy and unrivaled driveability
- Updated drive track eliminates staple movement, virtually eliminating jams
- Positive-locking adjustable depth-of-drive ensures consistently flush drives
- Hardened wear plates and safety protect tool from shingle damage

BC58

½" CROWN ⅝" STAPLE + 1" CAP

ITEM #4A0001N

21_{GA}



Features

- EZ-Load system for staples and caps
- Ultra-lightweight for ease of use and maneuverability
- Balanced and fast for greater productivity
- Side-mounted cap collator holds caps regardless of tool position

A11

⅞" CROWN ⅜" HAMMER STAPLER

ITEM #PC0700

20_{GA}



Features

- Rugged all-steel construction
- Easy to service and maintain
- Comfortable fluted handle with grip

Product Reference Chart

TOOL SPECS	PS15RXP	BC58	A11
Trigger	Contact	Contact	—
Operating Pressure	70–120 psi (4.8–8.3 bar)	60–95 psi (4.1–6.5 bar)	—
Air Consumption (60 CPM)	3.18 scfm	.77 scfm	—
Air Inlet	⅜" NPT	¼" NPT	—
Weight	5.5 lbs (2.5 kg)	4.1 lbs (2 kg)	2 lbs (.9 kg)
Height	9" (229 mm)	8.5" (216 mm)	1.75" (44.4 mm)
Length	15.25" (387 mm)	12.5" (317 mm)	12.3" (312.4 mm)
Width	4" (105 mm)	3.5" (89 mm)	—
Main Body Material	Aluminum	Aluminum	Steel
Warranty	5 yrs	5 yrs	1 yr
FASTENER SPECS	Fasteners are located on page 53		
Gauge	16	21	20
Crown	1"	½"	⅞"
Range	⅝"–1½"	⅝" Galv.	⅜"
Capacity	160	110	168
Angle/Collation	Taped and taped glued	Glued Staple, Laser Welded Cap	Straight Glued Strip
Series	P	M004092, Cap	H
TOOL FEATURES			
Depth-of-Drive	Yes, Tool-Free	No	—
Tool-Free Jam Clearing	Yes	No	Yes
Adjustable Exhaust	No	Yes	—

ROOFING, SIDING & FENCING FASTENERS

15° Smooth Shank Coil Nails

Siding, asphalt and fiberglass shingles and vapor barriers

Length	Point	Finish	Coating	Collation	Box Count	Item Code
¾" x .120"	Diamond	Galv	Plain	15° Flat Wire Welded Coil	7.2M	M003101
1" x .120"	Diamond	Galv	Plain	15° Flat Wire Welded Coil	7.2M	M003103
1¼" x .120"	Diamond	Galv	Plain	15° Flat Wire Welded Coil	7.2M	M003104
1½" x .120"	Diamond	Galv	Plain	15° Flat Wire Welded Coil	7.2M	M003105
1¾" x .120"	Diamond	Galv	Plain	15° Flat Wire Welded Coil	7.2M	M003106

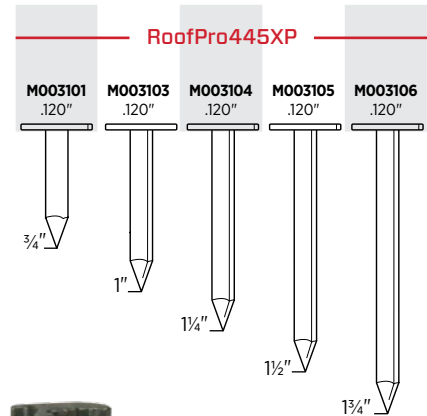

Vinyl Siding Attachment (Sold Separately)

Convert RoofPro™445XP and RoofPro™455XP into vinyl siding nailer

Fits Tool	Item Code
RoofPro™445XP	HA0308
RoofPro™455XP	MA0013



15° Smooth Shank Coil Nails

Siding, packaging, fencing, pallets and underlayment

Length	Point	Finish	Coating	Collation	Box Count	Item Code
1½" x .099"	Diamond	Bright	Sencote	15° Plastic Carrier Coil	6M	BD17APBC
2" x .092"	Diamond	Exterior	Sencote	15° Flat Wire Welded Coil	7.2M	EJ21ADBH
2¼" x .092"	Diamond	Galv	Sencote	15° Flat Wire Welded Coil	3.6M	ED23AABH
2¼" x .092"	Diamond	Exterior	Sencote	15° Conical Wire Welded Coil	7.2M	EJ23ADBH
2¼" x .092"	Diamond	Hot Dip	Sencote	15° Plastic Carrier Coil	3.6M	EJ23ASBC

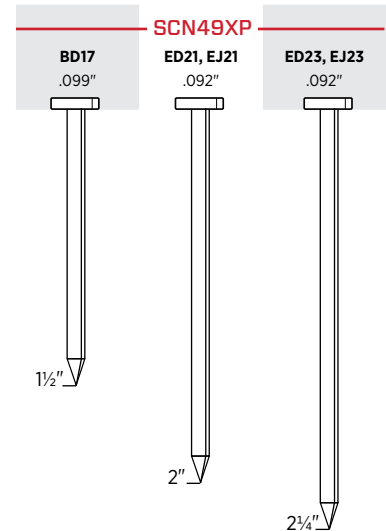

15° Ring Shank Coil Nails

Siding, packaging, fencing, wood shingles, crating and pallets

Length	Point	Finish	Coating	Collation	Box Count	Item Code
1/4" x .082"	Diamond	Bright	Sencote	15° Conical Wire Welded Coil	15M	SE15APB
1/4" x .082"	Diamond	Bright	Sencote	15° Flat Wire Welded Coil	14M	SE15APBH
1/2" x .082"	Diamond	Bright	Sencote	15° Flat Wire Welded Coil	11.2M	SE17APBH
3/4" x .082"	Diamond	Bright	Sencote	15° Conical Wire Welded Coil	12M	SE19APB
1 3/4" x .092"	Diamond	Hot Dip	Sencote	15° Flat Wire Welded Coil	3.6M	EL19ASBH
1 7/8" x .092"	Diamond	Galv	Sencote	15° Flat Wire Welded Coil	3.6M	EL20AABH
1 7/8" x .092"	Diamond	Hot Dip	Sencote	15° Flat Wire Welded Coil	3.6M	EL20ASBH
2" x .092"	Diamond	Hot Dip	Sencote	15° Flat Wire Welded Coil	3.6M	EL21ASBH
2 1/4" x .092"	Diamond	Galv	Sencote	15° Flat Wire Welded Coil	3.6M	EL23AABH
2 1/4" x .092"	Diamond	Hot Dip	Sencote	15° Plastic Carrier Coil	3.6M	EL23ASBC
2 1/4" x .092"	Diamond	Hot Dip	Sencote	15° Flat Wire Welded Coil	3.6M	EL23ASBH
2 1/2" x .092"	Diamond	Hot Dip	—	15° Plastic Carrier Coil	3.6M	EL25ASEC
1 3/4" x .092"	Diamond	Stainless 304	Sencote	15° Flat Wire Welded Coil	3.6M	EL19AGBH
2" x .092"	Diamond	Stainless 304	Sencote	15° Flat Wire Welded Coil	3.6M	EL21AGBH
2 1/4" x .092"	Diamond	Stainless 304	Sencote	15° Flat Wire Welded Coil	3.6M	EL23AGBH

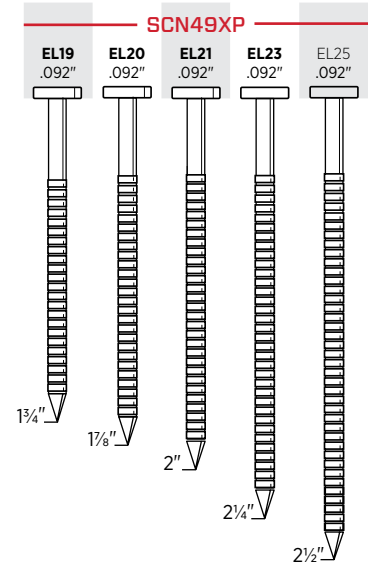
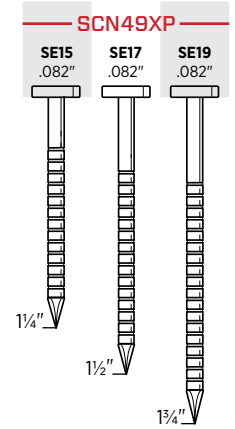

ROOFING, SIDING & FENCING FASTENERS

16^{GA}

1" Crown Heavy Wire Staples

Composite roofing, roofing felt, foam insulation board, house wrap, sheathing, corrugated containers, furniture/cabinets and butt joints

Length	Point	Finish	Coating	Collation	Box Count	Item Code
3/8"	Chisel	Galv	Plain	Glued	10M	P06BAA
1/2"	Chisel	Galv	Sencote	Taped	10M	P08BABT
5/8"	Chisel	Galv	Sencote	Taped	10M	P10BAB
5/8"	Divergent	Galv	Sencote	Glued	10M	P10FAB
5/8"	Chisel	Galv	Coated	Glued	10M	P10BPE
3/4"	Chisel	Galv	Sencote	Taped	10M	P11BAB
3/4"	Chisel	Galv	Coated	Glued	10M	P11BPE
7/8"	Chisel	Galv	Sencote	Taped	10M	P12BAB
1"	Chisel	Galv	Sencote	Taped	10M	P13BAB
1"	Chisel	Galv	Sencote	Glued	10M	P13BPE
1 1/4"	Chisel	Galv	Sencote	Taped	10M	P15BAB
1 1/4"	Chisel	Galv	Coated	Glued	10M	P15BPE
1 1/2"	Chisel	Galv	Sencote	Taped	10M	P17BAB
1"	Outside Chisel	Stainless 304	Sencote	Taped	5M	P13BGBN

*Use kit #YK083 with PS15RXP for 3/8"-5/8" staples

Use kit #YK0786 with RXP for 3/8"-5/8" staples

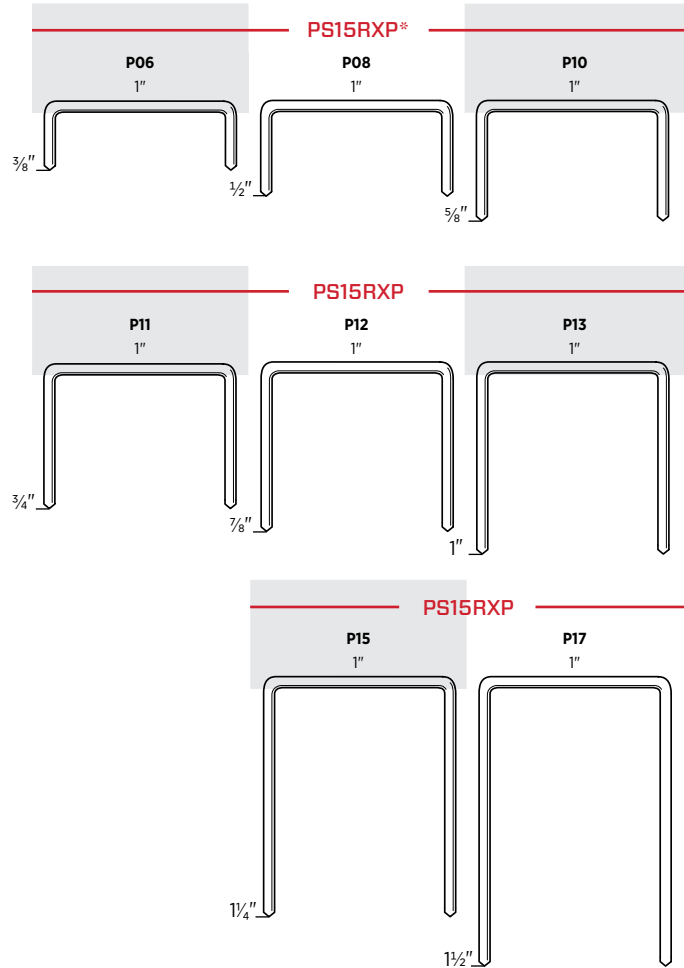

*Use kit #YK083 with PS15RXP for 3/8"-5/8" staples

20^{GA}

7/16" Crown Fine Wire Staples

Roofing, insulation and vapor barriers

Length	Point	Finish	Coating	Collation	Box Count	Item Code
3/8"	Chisel	Galv	Plain	Glued	5M	H06BAA

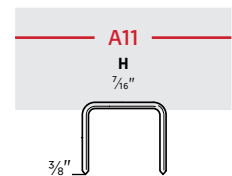

21^{GA}

1" Cap & 1/2" Crown Staples

Roof felt installation and house wrap

Length	Point	Finish	Coating	Collation	Box Count	Item Code
3/8"	Chisel	Galv	Plain	Glued	2.2M	M004092
1"	—	Plastic	—	Laser Weld	2.2M	—

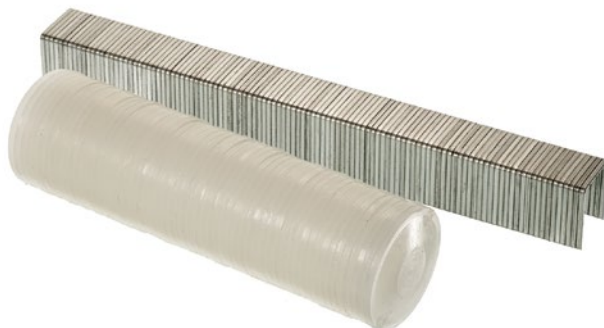
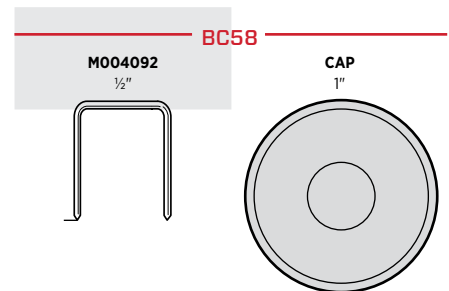

PALLETS & CRATING

THE DURABILITY TO DRIVE ALL DAY

SENCO's PalletPro™ heavy-duty coil nailers are built specifically for the challenges of pallets and crating. The PalletPro130 can drive fasteners as long as 5½" and hold up to 225 nails.

APPLICATIONS

Pallets, crates, heavy-duty framing and truss attachment

FEATURES

- Durable drivers and bumpers
- Flexible collation deflectors
- Dust guards for safe operation and extended use

Clinch and sisal anvil staple tools come in 18 and 20 gauge ½" and ⅞" crowns. Great for hand-held or mounted applications.

APPLICATIONS

Packaging, corrugated box fabrication, shoe making and bedding: basically any time two materials must be stapled and clinched together

FEATURES

- High-capacity magazines
- Extended reach capability
- Tool-free adjustable anvil opening
- Bottom-load magazines



PalletPro™57FXP

2¼" COIL NAILER

ITEM #4L0001N

15°



Features

- High load capacity
- Ultra-durability driver and piston bumper for long life
- Adjustable nail canister accommodates wide range of nails
- Body protection — side steel wear plates reduce abrasion of tool

PalletPro™100XP

4" COIL NAILER (SPECIAL ORDER TOOL)

ITEM #5L0001N

15°



Features

- High load capacity
- Includes optional heavy-duty threaded T-handle
- Flexible collation deflector and dust guard for improved safety in commercial environments
- Strengthened driver and bumper for extended use and reliable service

PalletPro™130XP

5⅞" COIL NAILER (SPECIAL ORDER TOOL)

ITEM #5M0001N

15°



Features

- High load capacity
- Includes optional heavy-duty threaded T-handle
- Flexible collation deflector and dust guard for improved safety in commercial environments
- Strengthened driver and bumper for extended use and reliable service

Product Reference Chart

TOOL SPECS	PalletPro™57FXP	PalletPro™100XP	PalletPro™130XP
Trigger	Contact	Contact	Sequential
Operating Pressure	70–120 psi (4.9–8.4 bar)	70–120 psi (4.9–8.4 bar)	70–120 psi (4.9–8.4 bar)
Air Consumption (60 CPM)	3.07 scfm	11.4 scfm	11.4 scfm
Air Inlet	⅜" NPT	⅜" NPT	⅜" NPT
Weight	5.9 lbs (2.67 kg)	11.5 lbs (5.24 kg)	13 lbs (5.9 kg)
Height	11.25" (286 mm)	16.5" (418 mm)	18" (457 mm)
Length	11.88" (302 mm)	13.25" (338 mm)	13" (330 mm)
Width	5.25" (123 mm)	6" (153 mm)	6.6" (168 mm)
Main Body Material	Aluminum	Aluminum	Aluminum
Warranty	5 yrs	5 yrs	5 yrs
FASTENER SPECS	Fasteners are located on pages 58–59		
Range	1"–2¼"	2¼"–4"	3"–5⅞"
Shank	.082"–.092"	.099"–.148"	.120"–.148"
Capacity	300–350	225–300	120–225
Angle/Collation	15° Flat Wire Welded Coil	15° Flat Wire Welded Coil	15° Flat Wire Welded Coil
Series	BK, ED, EJ, EL, SE	BE, BK, BL, BT, HK, GD, GL, HD, HL, KD	HD, HK, HL, KD, MD
TOOL FEATURES			
Tool-Free Jam Clearing	Yes	Yes	Yes
Depth-of-Drive	No	No	No
Debris Shield	Yes	Yes	Yes

DFPXP

20 Ga. 1/2" CROWN, 1/2" STAPLE
CLINCH TOOL

ITEM #8H0001N

20_{GA}



Features

- High-capacity magazine — less reloading means greater productivity
- Tool-free adjustable anvil opening
- Rubber comfort grip reduces vibration, slipping and fatigue
- Bottom-load magazine for quick reloading
- 6.9" throat allows for extended reach into cartons

F75LXP

18 Ga. 7/16" CROWN, 5/8" STAPLE
CLINCH TOOL

ITEM #8J0002N

18_{GA}



Features

- High-capacity magazine — less reloading means greater productivity
- Tool-free adjustable anvil opening
- Rubber comfort grip reduces vibration, slipping and fatigue
- Bottom-load magazine for quick reloading
- 6.9" throat allows for extended reach into cartons

F75SXP

18 Ga. 7/16" CROWN, 5/8" STAPLE
SISAL ANVIL

ITEM #8J0001N

18_{GA}



Features

- High-capacity magazine — less reloading means greater productivity
- Tool-free adjustable anvil opening
- Rubber comfort grip reduces vibration, slipping and fatigue
- Bottom-load magazine for quick reloading

Product Reference Chart

TOOL SPECS	DFPXP	F75LXP	F75SXP
Trigger	Sequential	Sequential	Sequential
Operating Pressure	65-100 psi (4-7 bar)	65-100 psi (4-7 bar)	65-100 psi (4-7 bar)
Air Consumption (60 CPM)	.7 scfm	.7 scfm	.8 scfm
Air Inlet	1/4" NPT	1/4" NPT	1/4" NPT
Weight	4.9 lbs (2.24 kg)	4.9 lbs (2.24 kg)	4.9 lbs (2.24 kg)
Height	12.9" (327 mm)	12.9" (327 mm)	12.9" (327 mm)
Length	14.9" (380 mm)	14.9" (380 mm)	14.9" (380 mm)
Width	3" (75 mm)	3" (75 mm)	3" (75 mm)
Main Body Material	Aluminum	Aluminum	Aluminum
Warranty	5 yrs	5 yrs	5 yrs
FASTENER SPECS	Fasteners are located on page 59		
Gauge	20	18	18
Crown	1/2"	7/16"	7/16"
Range	5/16"-5/8"	5/16"-5/8"	5/16"-5/8"
Capacity	230	152	152
Angle/Collation	Straight Glued Strip	Straight Glued Strip	Straight Glued Strip
Series	F	J	J
TOOL FEATURES			
Tool-Free Adjustable Anvil Opening	Yes	Yes	Yes
Bottom-Load Magazine	Yes	Yes	Yes
Extended Reach Capability	Yes	Yes	No

PALLETS & CRATING FASTENERS

15° Smooth Shank Coil Nails

Pallets, crates, fencing, siding and underlayment

Length	Point	Finish	Coating	Collation	Box Count	Item Code
2" x .092"	Diamond	Exterior	Sencote	15° Flat Wire Welded Coil	7.2M	EJ21ADBH
2¼" x .092"	Diamond	Galv	Sencote	15° Flat Wire Welded Coil	3.6M	ED23AABH

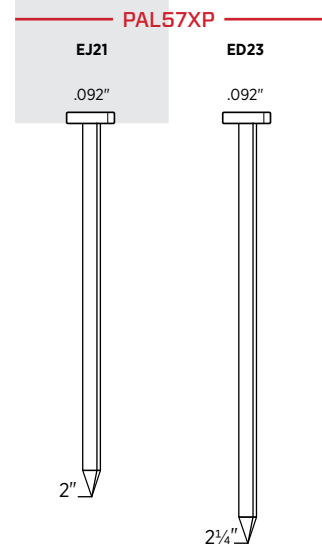

15° Smooth Shank Coil Nails

Pallets, framing, sheathing, subfloor, decks and trusses

Length	Point	Finish	Coating	Collation	Box Count	Item Code
2" x .113"	Diamond	Bright	Sencote	15° Flat Wire Welded Coil	6M	GD21APBF
2½" x .113"	Diamond	Bright	Sencote	15° Flat Wire Welded Coil	6M	GD25APBF
2½" x .131"	Diamond	Bright	Sencote	15° Flat Wire Welded Coil	3.6M	KD25APBF
3" x .120"	Diamond	Bright	Sencote	15° Flat Wire Welded Coil	4M	HD27APBF
3" x .131"	Diamond	Bright	Sencote	15° Flat Wire Welded Coil	3.6M	KD27APBF
3¼" x .131"	Diamond	Bright	Sencote	15° Flat Wire Welded Coil	3.6M	KD28APBF
3½" x .131"	Diamond	Bright	Sencote	15° Flat Wire Welded Coil	3.6M	KD29APBF
5" x .148"	Diamond	Bright	Sencote	15° Flat Wire Welded Coil	1.8M	MD34APBF
2" x .113"	Diamond	Galv	Sencote	15° Flat Wire Welded Coil	6M	GD21AABF
2½" x .113"	Diamond	Galv	Sencote	15° Flat Wire Welded Coil	6M	GD25AABF
3" x .131"	Diamond	Hot Dip	Sencote	15° Flat Wire Welded Coil	2.4M	KD27ASBF
3¼" x .131"	Diamond	Hot Dip	Sencote	15° Flat Wire Welded Coil	2.4M	KD28ASBF

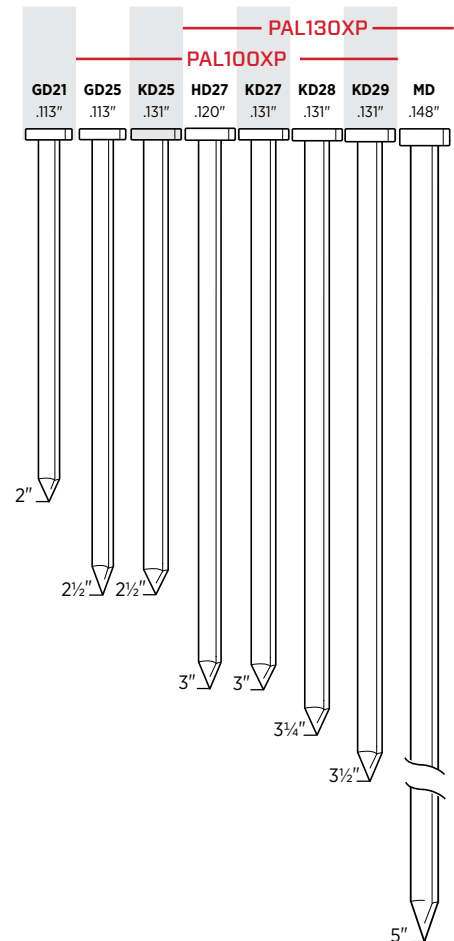

15° Ring Shank Coil Nails

Pallets, crates, fencing, wood shingles, siding and underlayment

Length	Point	Finish	Coating	Collation	Box Count	Item Code
1¼" x .082"	Diamond	Bright	Sencote	15° Flat Wire Welded Coil	14M	SE15APBH
1½" x .082"	Diamond	Bright	Sencote	15° Flat Wire Welded Coil	11.2M	SE17APBH
1¾" x .092"	Diamond	Hot Dip	Sencote	15° Flat Wire Welded Coil	3.6M	EL19ASBH
1⅞" x .092"	Diamond	Galv	Sencote	15° Flat Wire Welded Coil	3.6M	EL20AABH
1⅞" x .092"	Diamond	Hot Dip	Sencote	15° Flat Wire Welded Coil	3.6M	EL20ASBH
2" x .092"	Diamond	Hot Dip	Sencote	15° Flat Wire Welded Coil	3.6M	EL21ASBH
2¼" x .092"	Diamond	Galv	Sencote	15° Flat Wire Welded Coil	3.6M	EL23AABH
2¼" x .092"	Diamond	Hot Dip	Sencote	15° Flat Wire Welded Coil	3.6M	EL23ASBH
1¾" x .092"	Diamond	Stainless 304	Sencote	15° Flat Wire Welded Coil	3.6M	EL19AGBH
2" x .092"	Diamond	Stainless 304	Sencote	15° Flat Wire Welded Coil	3.6M	EL21AGBH
2¼" x .092"	Diamond	Stainless 304	Sencote	15° Flat Wire Welded Coil	3.6M	EL23AGBH

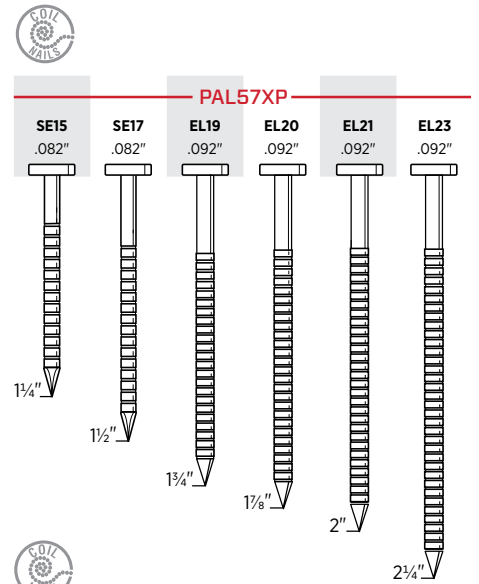

15° Ring Shank Coil Nails

Pallets, framing, sheathing, subfloor, decks and trusses

Length	Point	Finish	Coating	Collation	Box Count	Item Code
2" x .099"	Diamond	Bright	Sencote	15° Flat Wire Welded Coil	6.6M	BL21APBF
2" x .113"	Diamond	Bright	Sencote	15° Flat Wire Welded Coil	6M	GL21APBF
2⅜" x .113"	Diamond	Bright	Sencote	15° Flat Wire Welded Coil	6M	GL24APBF
2¼" x .099"	Diamond	Galv	Sencote	15° Flat Wire Welded Coil	6.6M	BE23AABF
2⅜" x .113"	Diamond	Hot Dip	Sencote	15° Flat Wire Welded Coil	2.7M	GL24ASBF
3" x .120"	Diamond	Hot Dip	Sencote	15° Flat Wire Welded Coil	2.4M	HL27ASBF
2⅜" x .113"	Diamond	Stainless 304	Sencote	15° Flat Wire Welded Coil	2.7M	GL24AGBF

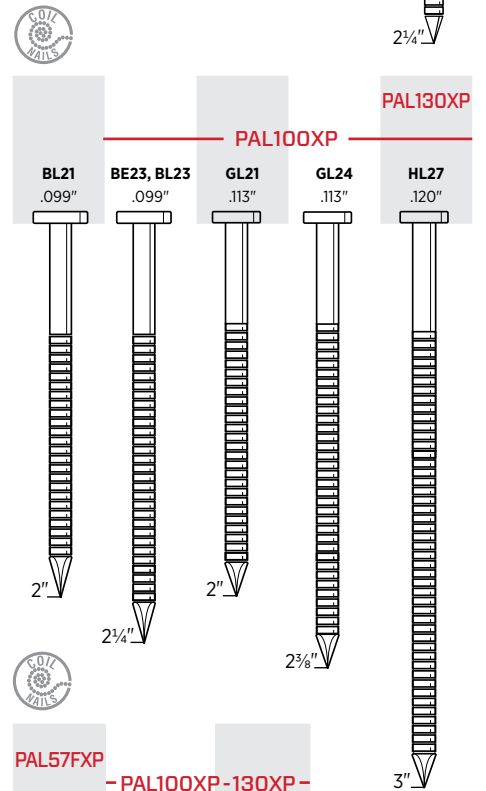

15° Step Ring Shank Nails

Superior fastening in subfloor applications

Length	Point	Finish	Coating	Collation	Box Count	Item Code
2" x .099"	Diamond	Bright Basic	Sencote	15° Flat Wire Welded Coil	6.6M	BT21APBF
2⅜" x .113"	Diamond	Bright Basic	Sencote	15° Flat Wire Welded Coil	4M	GT24APBF
2½" x .131"	Diamond	Bright Basic	Sencote	15° Flat Wire Welded Coil	4M	KT25APBF

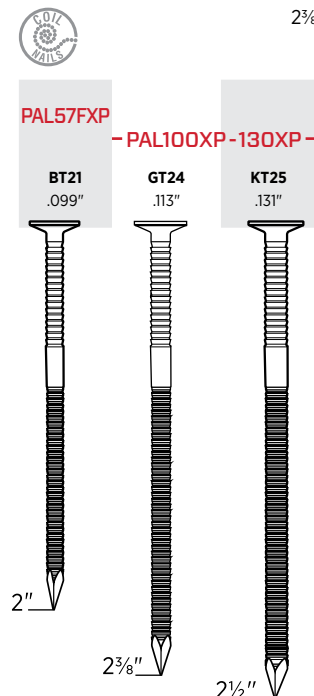

Step Ring Pallet Coil Nails

- Superior fastening in pallet applications
- Tested and proven to reduce raised nail heads
- Unique double rings shank design reduces the potential of nail backing outs

PALLETS & CRATING FASTENERS

15° Screw Shank Coil Nails

Pallets, framing, sheathing, subfloor, decks and trusses

Length	Point	Finish	Coating	Collation	Box Count	Item Code
2" x .099"	Blunt Dia.	Bright	Sencote	15° Flat Wire Welded Coil	9M	BK21BPBFN
2¼" x .099"	Blunt Dia.	Bright	Sencote	15° Flat Wire Welded Coil	9M	BK23BPBFN
2½" x .099"	Blunt Dia.	Bright	Sencote	15° Flat Wire Welded Coil	6M	BK25BPBFN
3" x .120"	Diamond	Bright	Sencote	15° Flat Wire Welded Coil	4M	HK27APBFN

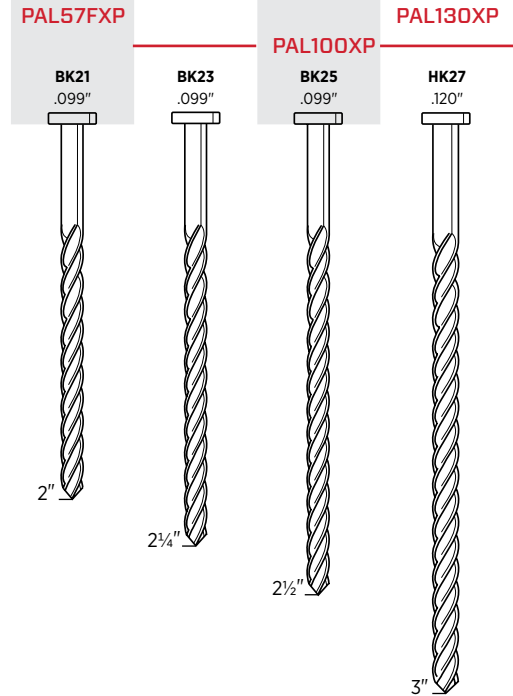

20^{GA} ½" Crown Fine Wire Staples

Packaging, set-up boxes and bedding

Length	Point	Finish	Coating	Collation	Box Count	Item Code
¾"	Chisel	Galv	Sencote	Glued Strip	24M	F05BAAP
¾"	Chisel	Galv	Sencote	Glued Strip	10M	F06BAA
¾"	Chisel	Galv	Sencote	Glued Strip	24M	F06BAAP
½"	Chisel	Galv	Sencote	Glued Strip	10M	F08BAAN
½"	Chisel	Galv	Sencote	Glued Strip	15M	F08BAAP
¾"	Chisel	Stainless 304	Sencote	Glued Strip	10M	F06BGA

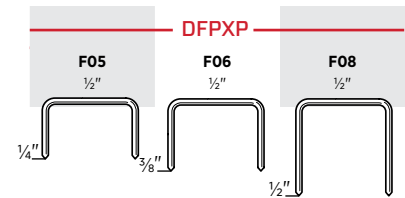

18^{GA} 7/16" Crown Fine Wire Staples

For assembling packaging and joining corrugated materials

Length	Point	Finish	Coating	Collation	Box Count	Item Code
¾"	Chisel	Galv	Plain	Glued Strip	5M	J06BAA
½"	Chisel	Galv	Plain	Glued Strip	5M	J08BAAN
¾"	Chisel	Galv	Plain	Glued Strip	5M	J10BAAN

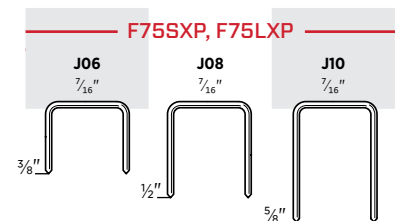

UPHOLSTERY & FURNITURE

SENCO HAS YOU COVERED. SINCE 1948.

SENCO offers a range of fine and medium wire staplers for upholstery and furniture assembly. Our upholstery staplers are the most customizable in the industry, with long nosepieces, extended magazines and a wide range of fasteners for any project.

APPLICATIONS

Upholstery, furniture assembly, cabinets, bedding, picture frames, molding, roof felt, house wrap, RV construction

FEATURES

- Lightweight
- Ergonomic
- Variety of configurations



SFT10XP FAMILY

3/16", 3/8", 7/16", 1/2" CROWN,
5/8" FINE WIRE STAPLERS

SFT10XP

22_{GA}

20_{GA}



Features

- Heavy-duty steel cap
- Short trigger stroke
- Rear exhaust keeps oil off fabric
- Automatic models have adjustable speed triggers

Models and Item Codes

Crown	Ga	Staple	Description	Item Code
3/16"	22	A/D Wire	Standard	6S0001N
3/16"	22	A/D Wire	Auto	6S0101N
1/2"	22	B Wire	Standard	6S0011N
3/8"	22	C Wire	Standard	6S0021N
3/8"	22	C Wire	Auto	6S0121N
3/16"	20	E Wire	Standard	6S0031N
1/2"	20	F Wire	Standard	6S0041N
3/8"	20	G Wire	Standard	6S0051N

SFT10XP FAMILY

3/16", 3/8", 7/16", 1/2" CROWN,
5/8" FINE WIRE STAPLERS

DOUBLE LENGTH MAGAZINE

22_{GA}

20_{GA}



Features

- Heavy-duty steel cap
- Short trigger stroke
- Rear exhaust keeps oil off fabric
- Automatic models have adjustable speed triggers

Models and Item Codes

Crown	Ga	Staple	Description	Item Code
1/2"	22	B Wire	Standard	6S0211N
1/2"	22	B Wire	Auto	6S0311N
3/8"	22	C Wire	Standard	6S0221N
3/8"	22	C Wire	Auto	6S0321N
1/2"	20	F Wire	Auto	6S0341N
3/8"	20	G Wire	Standard	6S0251N
3/8"	20	G Wire	Auto	6S0351N
7/16"	20	H Wire	Auto	6S0361N

SFT10XP FAMILY

3/16", 3/8", 7/16", 1/2" CROWN,
5/8" FINE WIRE STAPLERS

LONG NOSE

22_{GA}



Features

- Heavy-duty steel cap
- Short trigger stroke
- Rear exhaust keeps oil off fabric
- Automatic models have adjustable speed triggers

Models and Item Codes

Crown	Ga	Staple	Description	Item Code
3/8"	22	C Wire	Standard	6S0421N

Product Reference Chart

TOOL SPECS	SFT10XP
Trigger	Sequential, Auto
Operating Pressure	60-95 psi (4.1-6.5 bar)
Air Consumption (60 CPM)	.77 scfm
Air Inlet	1/4" NPT
Weight	2.1 lbs (0.955 kg)
Height	6.57" (167 mm)
Length	8.58" (218 mm)
Width	1.65" (42 mm)
Main Body Material	Aluminum
Warranty	5 yrs
FASTENER SPECS	Fasteners are located on pages 63-64
Gauge	22, 20
Crown	3/16", 3/8", 7/16", 1/2"
Range	1/4"-5/8"
Capacity	110-92
Angle/Collation	Straight Glued Strip
Series	A, B, C, D, E, F, G, H



Stapling Upholstery for Over 70 Years

SENCO® offers 18 configurations of upholstery staplers and over 40 combinations of staple length, crown and gauge.

SFW09

3/8" CROWN, 5/8" FINE WIRE STAPLER

ITEM #4C0001N

22_{GA}



Features

- Rear exhaust keeps oil off fabric
- Full 1" lip length
- Rear magazine bumper protects fabric
- Rounded steel cap won't snag fabric

NS20BXP

7/16" CROWN, HEAVY WIRE STAPLER

ITEM #9Y0001N

17_{GA}

16_{GA}



Features

- 20% more powerful than the standard NS20XP for the most demanding applications
- Enhanced EZ-Clear™ latch allows for quick access to clear fasteners
- Updated aggressive locking feature
- New drive track design eliminates movement of the staple

The NS20BXP is the Benchmark Stapler for the Furniture Industry.

- 20% more powerful than all other staplers in its class to handle even the toughest engineered woods.
- Drives both 16 and 17 gauge, 7/16" crown staples (1" to 2" in length).
- The combination of class-leading power, durability and ergonomics make it an unrivaled professional tool.



Vinyl Siding Attachment (Sold Separately)

Converts NS20BXP into a vinyl siding stapler

Fits Tools	ITEM #
NS20BXP	HC0788

Product Reference Chart

TOOL SPECS	SFW09	NS20BXP
Trigger	Dual	Contact
Operating Pressure	60-95 psi (4.1-6.5 bar)	70-120 psi (4.8-8.3 bar)
Air Consumption (60 CPM)	.77 scfm	3.98 scfm
Air Inlet	1/4" NPT	3/8" NPT
Weight	2.1 lbs (0.955 kg)	5.8 lbs (2.6 kg)
Height	6" (152 mm)	11" (279 mm)
Length	9.25" (235 mm)	15" (381 mm)
Width	1.63" (41 mm)	4" (102 mm)
Main Body Material	Aluminum	Aluminum
Warranty	5 yrs	5 yrs
FASTENER SPECS	Fasteners are located on pages 63, 65	
Gauge	22	17 (O-Wire), 16 (N-Wire)
Crown	3/8"	7/16"
Range	5/32" - 5/8"	1" - 2"
Capacity	110-168	160
Angle/Collation	Straight Glued Strip	Straight Glued/Taped Strip
Series	C	N, O

UPHOLSTERY & FURNITURE FASTENERS

22^{GA} 3/16" Crown Fine Wire Staples

Furniture upholstery, felt, insulation, casebacks, screening and shoes

Length	Point	Finish	Coating	Collation	Box Count	Item Code
1/4"	Chisel	Galv	Sencote	Straight Glued Strip	10M	A04BAAN
3/8"	Chisel	Galv	Sencote	Straight Glued Strip	30M	A06BABN
3/8"	Chisel	Galv	Sencote	Straight Glued Strip	40M	A06BABP
1/2"	Chisel	Galv	Sencote	Straight Glued Strip	20M	A08BAB
1/2"	Chisel	Galv	Sencote	Straight Glued Strip	30M	A08BABP
5/8"	Chisel	Galv	Sencote	Straight Glued Strip	20M	D10BABN
5/8"	Chisel	Galv	Sencote	Straight Glued Strip	23M	D10BABPN

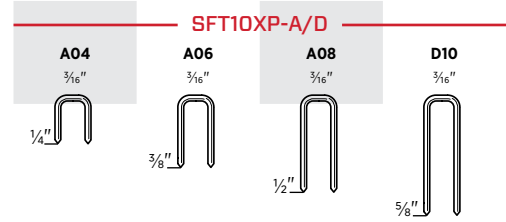

22^{GA} 1/2" Crown Fine Wire Staples

Furniture upholstery, felt, insulation, casebacks, screening and shoes

Length	Point	Finish	Coating	Collation	Box Count	Item Code
1/4"	Chisel	Galv	Plain	Straight Glued Strip	25M	B04BAAPN
3/8"	Chisel	Galv	Plain	Straight Glued Strip	40M	B06BAAP
1/2"	Chisel	Galv	Plain	Straight Glued Strip	25M	B08BAAP

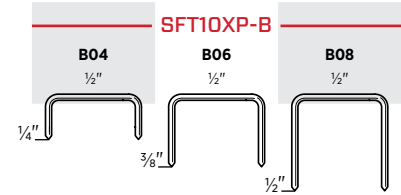

22^{GA} 3/8" Crown Fine Wire Staples

Furniture upholstery, felt, insulation, casebacks, screening and shoes

Length	Point	Finish	Coating	Collation	Box Count	Item Code
5/32"	Chisel	Galv	Plain	Straight Glued Strip	60M	C02BAAPN
3/16"	Chisel	Galv	Plain	Straight Glued Strip	55M	C03BAAPN
1/4"	Chisel	Galv	Plain	Straight Glued Strip	35M	C04BAAP
5/16"	Chisel	Galv	Plain	Straight Glued Strip	28M	C05BAAPN
3/8"	Chisel	Galv	Plain	Straight Glued Strip	50M	C06BAAP
7/16"	Chisel	Galv	Plain	Straight Glued Strip	40M	C07BAAPN
1/2"	Chisel	Galv	Plain	Straight Glued Strip	35M	C08BAAP
5/8"	Chisel	Galv	Plain	Straight Glued Strip	27M	C10BAAP
3/16"	Chisel	Stainless 304	Plain	Straight Glued Strip	25M	C03BGAN
1/4"	Chisel	Stainless 304	Plain	Straight Glued Strip	25M	C04BGAN
3/8"	Chisel	Stainless 304*	Plain	Straight Glued Strip	10M	C06BHA
3/8"	Chisel	Stainless 304	Plain	Straight Glued Strip	10M	C06BGA

* High-Tensile 304 Stainless Steel

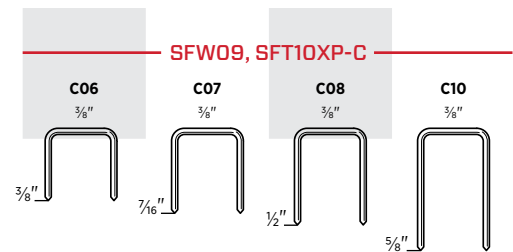
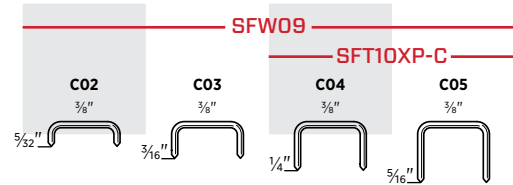

21^{GA} 3/16" Crown Fine Wire Staples

Furniture upholstery, felt, insulation, casebacks, screening and shoes

Length	Point	Finish	Coating	Collation	Box Count	Item Code
5/8"	Chisel	Galv	Sencote	Straight Glued Strip	10M	W10BAB

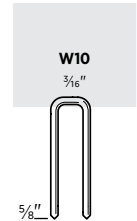

UPHOLSTERY & FURNITURE FASTENERS

20^{GA} 3/16" Crown Fine Wire Staples

Furniture upholstery, felt, insulation, casebacks, screening and shoes

Length	Point	Finish	Coating	Collation	Box Count	Item Code
3/8"	Chisel	Galv	Plain	Straight Glued Strip	10M	E06BAA
1/2"	Chisel	Galv	Plain	Straight Glued Strip	10M	E08BAA
5/8"	Chisel	Galv	Plain	Straight Glued Strip	5M	E10BAA

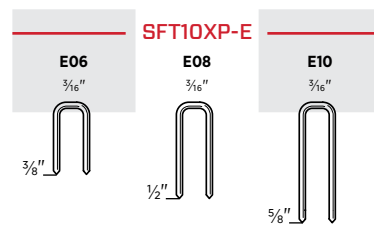

20^{GA} 1/2" Crown Fine Wire Staples

Upholstery, felt, insulation and casebacks

Length	Point	Finish	Coating	Collation	Box Count	Item Code
1/4"	Chisel	Galv	Plain	Straight Glued Strip	10M	F04BAAN
1/4"	Chisel	Galv	Plain	Straight Glued Strip	17M	F04BAAP
5/16"	Chisel	Galv	Plain	Straight Glued Strip	24M	F05BAAP
3/8"	Chisel	Galv	Plain	Straight Glued Strip	10M	F06BAA
3/8"	Chisel	Galv	Plain	Straight Glued Strip	24M	F06BAAP
1/2"	Chisel	Galv	Plain	Straight Glued Strip	10M	F08BAAN
1/2"	Chisel	Galv	Plain	Straight Glued Strip	15M	F08BAAP
3/8"	Chisel	Stainless 304	Plain	Straight Glued Strip	10M	F06BGA

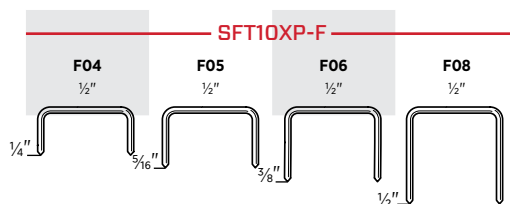

20^{GA} 3/8" Crown Fine Wire Staples

Upholstery, felt, insulation and casebacks

Length	Point	Finish	Coating	Collation	Box Count	Item Code
1/4"	Chisel	Galv	Plain	Straight Glued Strip	10M	G04BAAN
3/8"	Chisel	Galv	Plain	Straight Glued Strip	5M	G06BABN
1/2"	Chisel	Galv	Plain	Straight Glued Strip	5M	G08BAB

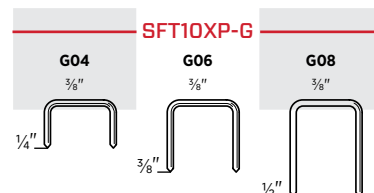

20^{GA} 7/16" Crown Fine Wire Staples

Upholstery, felt, insulation and casebacks

Length	Point	Finish	Coating	Collation	Box Count	Item Code
3/8"	Chisel	Galv	Plain	Straight Glued Strip	5M	H06BAA



UPHOLSTERY & FURNITURE FASTENERS

17^{GA} 7/16" Crown Heavy Wire Staples*

Furniture frames and crates						
Length	Point	Finish	Coating	Collation	Box Count	Item Code
1/4"	Chisel	Bright	Sencote	Glued	21.12M	O15BRBBN
1/8"	Chisel	Bright	Sencote	Glued	17.6M	O16BRBBN
1/2"	Chisel	Bright	Sencote	Glued	17.6M	O17BRBBN
1/8"	Chisel	Bright	Sencote	Glued	17.6M	O18BRBBN
1/4"	Chisel	Bright	Sencote	Glued	14.08M	O19BRBBN

*Compatible with NS20XP, NS20BXP, SNS200XP, SNS200XP-BST, SNS41 staplers manufactured after 09/2010. SNS44XP and SNS45XP staplers manufactured after 05/2010. For older tools, order upgrade kits SNS41-YK0794, SNS44-YK0793, SNS45-FA0186.

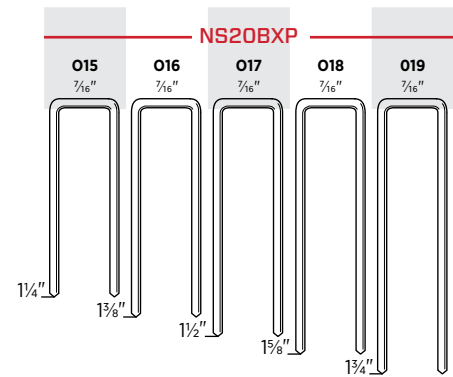

16^{GA} 7/16" Crown Heavy Wire Staples

Cabinets, casebacks, drawers and upholstery						
Length	Point	Finish	Coating	Collation	Box Count	Item Code
3/4"	Chisel	Bright	Sencote	Glued	5M	N11BRB
1"	Chisel	Bright	Sencote	Glued	5M	N13BRB
1/8"	Chisel	Bright	Sencote	Taped	10M	N14BRB
1/4"	Chisel	Bright	Sencote	Taped	10M	N15BRB
1/8"	Chisel	Bright	Sencote	Taped	10M	N16BRB
1/2"	Chisel	Bright	Sencote	Taped	10M	N17BRB
1/8"	Chisel	Bright	Sencote	Taped	10M	N18BRB
1/4"	Chisel	Bright	Sencote	Taped	10M	N19BRB
2"	Chisel	Bright	Sencote	Taped	10M	N21BRB
1/2"	Chisel	Galv	Sencote	Glued	5M	NO8BABN
1/2"	Chisel	Galv*	Sencote	Glued	5M	NO8BBBN
1/2"	Diverg	Galv*	Sencote	Glued	5M	NO8FBB
5/8"	Chisel	Galv	Sencote	Glued	5M	N10BAB
3/4"	Chisel	Galv	Sencote	Glued	5M	N11BAB
3/4"	Diverg	Galv*	Sencote	Glued	5M	N11FBB
7/8"	Chisel	Galv	Sencote	Glued	5M	N12BABN
7/8"	Diverg	Galv	Sencote	Glued	5M	N12FABN
1"	Chisel	Galv	Sencote	Glued	5M	N13BAB
1"	Diverg	Galv	Sencote	Glued	5M	N13FAB
1/8"	Chisel	Galv	Sencote	Taped	10M	N14BAB
1/4"	Chisel	Galv	Sencote	Taped	10M	N15BAB
1/4"	Diverg	Galv	Sencote	Glued	10M	N15FAB
1/8"	Chisel	Galv	Sencote	Taped	10M	N16BAB
1/2"	Chisel	Galv	Sencote	Taped	10M	N17BAB
1/2"	Chisel	Galv	Sencote	Glued	10M	N17BPE
1/8"	Chisel	Galv	Sencote	Glued	10M	N18BAB
1/4"	Chisel	Galv	Sencote	Taped	10M	N19BAB
1/4"	Chisel	Galv	Sencote	Glued	10M	N19BPE
2"	Chisel	Galv	Sencote	Taped	10M	N21BAB
2"	Chisel	Galv	Sencote	Glued	10M	N21BPE
1/4"	Chisel	Stainless 304	Sencote	Glued	3M	N15BGB
1/2"	Chisel	Stainless 304	Sencote	Glued	3M	N17BGB
1/4"	Chisel	Stainless 304	Sencote	Glued	3M	N19BGBN
2"	Chisel	Stainless 304	Sencote	Glued	3M	N21BGBN

*Galvanized High-Tensile Steel

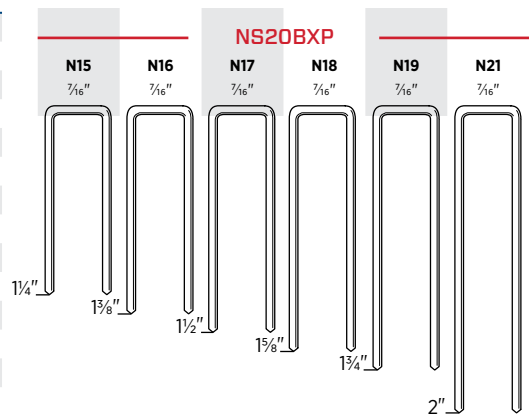
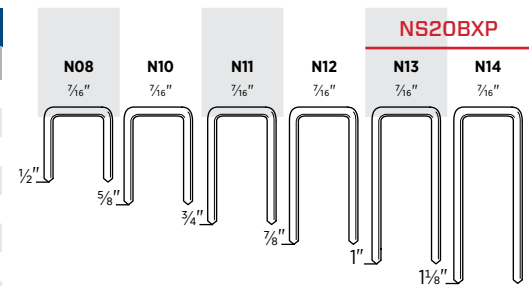

FLOORING

HARDWOOD FLOORING DONE RIGHT

Hardwood floors aren't so hard to install with our SHF200 and SHFS200 stand-up flooring tools. With long, ergonomic handles and bases that easily adjust to any floor thickness, you will get your job done in no time. SENCO is committed to creating industry-leading flooring tools to make your job easier.



SHF200

2" PNEUMATIC MALLET ACTUATED
HARDWOOD FLOORING CLEAT NAILER

ITEM #8D0001N

16_{GA}



Features

- Innovative non-marring base that adjusts between ½" and ¾" flooring without the use of tools
- Safety trigger prevents accidental ejection of fasteners
- Lightweight and well balanced, yet 5% more powerful than competitive flooring nailers
- Extra-long ergonomic handle reduces user fatigue

SLS20XP-HF

¾" CROWN, 1" ENGINEERED &
HARDWOOD FLOOR STAPLER

ITEM #490021N

19_{GA}



Features

- Never-Lube® design — no oil required
- Front block easily adjusts to floor thickness
- Industry-exclusive safety controls staple placement
- Power-adjusted motor drives staples to consistent and controllable depth

Product Reference Chart

TOOL SPECS	SHF200	SLS20XP-HF
Trigger	Sequential	Sequential
Operating Pressure	90-110 psi (6.2-7.6 bar)	70-120 psi (4.8-8.3 bar)
Air Consumption (60 CPM)	2.52 scfm	1.92 scfm
Air Inlet	¼" NPT	¼" NPT
Weight	10.1 lbs (4.58 kg)	3.2 lbs (1.5 kg)
Height	21.5" (546 mm)	9" (228 mm)
Length	17.8" (452 mm)	13" (332 mm)
Width	3.1" (78 mm)	3" (76 mm)
Main Body Material	Aluminum	Aluminum
Warranty	5 yrs	5 yrs
FASTENER SPECS	Fasteners are located on page 68	
Gauge	16	19
Crown	L-Head	¾"
Range	1 ½"-2"	⅝"-1"
Capacity	107	168
Angled/Collation	Straight Glued Strip	Straight Glued Strip
Series	RW	R
FLOORING MATERIAL		
Hardwood	Yes	Yes
Hardwood Laminate	Yes	Yes
Board Thickness	½", ⅝", ¾", ⅜" (12-26 mm)	¼", ⅝", ⅜" (6-10 mm)

16_{GA}

L-Head Flooring Cleat Nails

$\frac{1}{2}$ "¹, $\frac{5}{8}$ "², $\frac{3}{4}$ "³, $\frac{7}{8}$ "⁴ Solid hardwood flooring

Length	Point	Finish	Coating	Collation	Box Count	Item Code
1½"	Blunt Diamond	Bright	N/A	Straight Glued Strip	1M	RW17BPE
1¾"	Blunt Diamond	Bright	N/A	Straight Glued Strip	1M	RW19BPE
2"	Blunt Diamond	Bright	N/A	Straight Glued Strip	1M	RW21BPE
2"	Blunt Diamond	Stainless 304	N/A	Straight Glued Strip	1M	RW21BGE

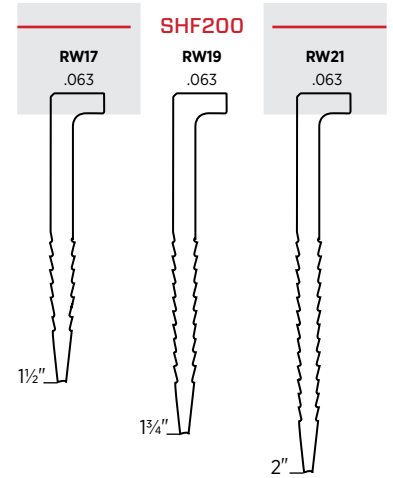

19_{GA}

3/16" Crown Flooring Staples

$\frac{1}{4}$ "¹, $\frac{3}{8}$ "², $\frac{1}{2}$ "³ Engineered and hardwood floors

Length	Point	Finish	Coating	Collation	Box Count	Item Code
5/8"	Chisel	Galv	Sencote	Straight Glued Strip	5M	R10BAB
¾"	Chisel	Galv	Sencote	Straight Glued Strip	5M	R11BAB
1"	Chisel	Galv	Sencote	Straight Glued Strip	5M	R13BAB

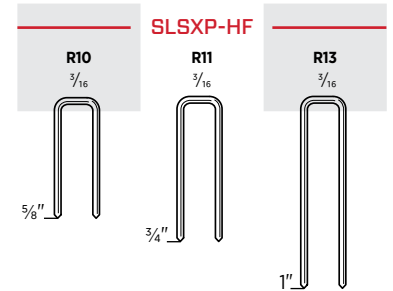

Get the Job Done.

With genuine SENCO compressors & accessories.

SENCO continuously strives to offer a wide selection of compressors, accessories, and parts to complete our full-line of fastening systems. Our commitment is to bring you the highest quality products to help you get the job done right.



COMPRESSORS

SENCO compressors are made to exacting standards. Only the highest quality components are used to provide the reliability expected from a SENCO product.

AIR HOSES

SENCO offers a wide variety of air hoses that allow you to choose the right solution for your job site. Our NEW Premium Hybrid hose provides the ultimate in flexibility and memory resistance, even in extremely cold temperatures. Quick Couple Rubber Hose is the standard for the professional on the job site with its tough flexible neoprene cover. ProFlex Reinforced Polyurethane Hose is the lightest weight non-marring flexible hose. PVC is resistant to lubricating oils, chemicals, and ultraviolet sunlight.



REGULATORS, GAUGES & LUBRICANTS

SENCO's assortments of regulators, gauges, oils and lubricants are chosen to satisfy the demanding requirements of the job site and deliver professional durability and quality. All will accurately replace the damaged component on SENCO units as well as many others.

PLUGS & COUPLERS

SENCO quick connect coupler and plug fittings are available in the most popular Industrial Interchange styles and sizes. Quick connect couplers are also available in the Universal style to work with other style plugs.

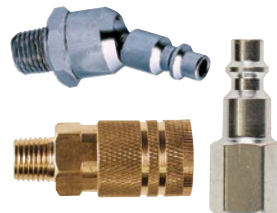

TOOL BELT HOOKS

SENCO offers a variety of belt hooks to allow the professional the ability to use both hands without worrying about dropping their pneumatic tool.

AIR COMPRESSORS & KITS

THE INNOVATION YOU'VE COME TO EXPECT, THE QUALITY YOU ALREADY KNOW

Whether you need an air compressor for punch-out jobs or for all-day performance, SENCO offers high quality, reliable options to meet your needs.

FEATURES

SENCO has you covered with industry leading compressors that provide plenty of tank storage and air flow for the job site or professional shop. Many feature an oil-free pump design to reduce maintenance and have integrated panels that provide easy access to control knobs. There's even a compressor equipped with

dual couplers so you can run two hoses simultaneously. Count on quickly getting back to work - we offer compressors that have pump up times of less than 40 seconds. You can easily monitor output pressure with individual tank and outlet gauges.

A full line of hoses and accessories is also available.



PC1131

2 HP (RUNNING) 4.3 GALLON TWIN TANK AIR COMPRESSOR



Features

- Cast-iron cylinder for superior pump life
- Compact twin stack tank design
- Heavy-duty induction motor

PC1010

½ HP (RUNNING) 1 GALLON FINISH AND TRIM AIR COMPRESSOR



Features

- Ultra-quiet — 68 dBA
- Ultra-light — 20 lbs
- Heavy-duty induction motor

PC0968

1 HP (RUNNING) 2½ GALLON TWIN TANK FINISH AND TRIM AIR COMPRESSOR



Features

- Compact twin stack tank design
- Lightweight — 38 lbs
- Heavy-duty induction motor

PC1010N

½ HP (RUNNING) 1 GALLON FINISH AND TRIM AIR COMPRESSOR



Features

- Ultra-quiet — 68 dBA
- Ultra-light — 21 lbs
- Heavy-duty induction motor

PC1280

1½ HP (RUNNING) 6 GALLON FINISH AND TRIM AIR COMPRESSOR



Features

- Compact and balanced pancake tank design
- Lightweight — 38 lbs
- Dual quick connect couplers

PC0947

2" FINISHPRO®18 BRAD NAILER AND PC1010 COMPRESSOR KIT



18 GA

Features

- 1 gallon PC1010 compressor
- 2" 18 gauge brad nailer
- Everything you need to get started

Air Compressor Reference Chart

SPECS	PC1131	PC0968	PC1280	PC1010	PC1010N
Motor	Induction	Induction	Universal	Induction	Induction
Amps	14	8	12	4	4
Power Source	115 Volts	115 Volts	115 Volts	115 Volts	115 Volts
SCFM @ 90 PSI	4.4	2.2	2.8	0.7	0.7
Max PSI	125	135	150	135	135
Weight	60 lbs (27 kg)	38 lbs (17.24 kg)	38 lbs (17.24 kg)	20 lbs (9.07 kg)	21 lbs (9.53 kg)
Height	14.5" (368 mm)	13.5" (343 mm)	18" (457 mm)	13" (330 mm)	12.25" (311 mm)
Length	20.5" (521 mm)	16" (406 mm)	17" (432 mm)	14" (356 mm)	11.5" (292 mm)
Width	16.5" (419 mm)	15" (381 mm)	16.3" (414 mm)	10" (254 mm)	14" (356 mm)
Warranty	1 yr	1 yr	1 yr	1 yr	1 yr
FEATURES					
Thermal Over-load Protector	Yes	Yes	Yes	Yes	Yes
Pump	Oil-Lube	Oil-Free	Oil-Free	Oil-Free	Oil-Free
Pump Up/Recovery Time	67 sec./16 sec.	82 sec./17 sec.	152 sec./33 sec.	125 sec./30 sec.	125 sec./30 sec.
¾" Quick Connect Coupler	1	1	2 (Dual)	1	1
Regulator	Yes	Yes	Yes	Yes	Yes
Individual Tank & Outlet Gauges	Yes	Yes	Yes	Yes	Yes
Cold Start Valve	Yes	No	No	No	No
CSA Approved	Yes	Yes	Yes	Yes	Yes

Tool Kit Ref. Chart

KIT SPECS	PC0947
Compressor	PC1010
Tool	FinishPro® 18
Trigger	Contact
Tool Operating Pressure	70-95 psi
Tool Air Inlet	¼" NPT
Tool Weight	3 lbs (1.6 kg)
Tool Height	9.3" (238 mm)
Tool Length	9.75" (248 mm)
Kit Warranty	1 yr
Coil Hose	¼" x 25'
Air Fittings	Yes
Tool Oil & Safety Glasses	Yes
Variety Pack of Fasteners	18 Ga. Brads
FASTENERS	
Gauge	18 Ga. Brads
Range	⅝"-2"

ACCESSORIES

FILTERS, REGULATORS, LUBRICANTS, PLUGS, COUPLERS, HOSES, PART KITS AND MORE

SENCO offers an assortment of accessories that are precision engineered to meet the demanding requirements of professionals. Be sure that your tools and compressors are running at peak performance by using SENCO certified replacement parts, accessories, hoses, oils and lubricants.



Air Hoses

SENCO offers a wide variety of air hoses in various materials, sizes and specifications for your job site.

(FPT) - Female Pipe Thread
(MPT) - Male Pipe Thread

Quick Couple Rubber Hose

SENCO's premium air hoses:

- Can handle up to 250 psi working pressure
- Oil-resistant nitrile tube
- Braided textile reinforcing for max strength and kink resistance
- Remains flexible at temperatures from -40° to 200°F
- 4-to-1 working pressure to burst safety factor
- Tough, flexible neoprene cover

	Hose Size	Length	Qty.	ITEM #
Gray with Industrial Interchange Plug and Coupler Fittings	¼"	50 ft	1	PC0064
Gray with Industrial Interchange Plug and Coupler Fittings	¼"	100 ft	1	PC1152
Gray with Industrial Interchange Plug and Coupler Fittings	¾"	50 ft	1	PC0065



GRAY WITH PLUG & COUPLER
PC0064, PC1152,
PC0065

ProFlex™ Reinforced Polyurethane Red Air Hose

Lightest available non-marring flexible hose

- Flexible in all weather (-48° to 150°F)
- Working pressure: 250 psi
- Durable — oil and fuel resistant
- MPT-threaded ends

Description	Hose Size	Length	Qty.	ITEM #
ProFlex™ with MPT Ends (Use with FPT-Type Fittings)	¼"	50 ft	1	PC0977
ProFlex™ with MPT Ends (Use with FPT-Type Fittings)	¼"	100 ft	1	PC0978
ProFlex™ with MPT Ends (Use with FPT-Type Fittings)	¾"	50 ft	1	PC0979



PROFLEX WITH MPT ENDS
PC0977, PC0978,
PC0979

Premium Hybrid Polymer Air Hose

- Provides the ultimate in flexibility and memory resistance, even in extreme cold
- Offers the best combination of strength and flexibility on the market

Description	Hose Size	Length	Qty.	ITEM #
Hybrid with MPT Ends (Use with FPT-Type Fittings)	¼"	50 ft	1	PC1319
Hybrid with MPT Ends (Use with FPT-Type Fittings)	¼"	100 ft	1	PC1320
Hybrid Field-Repairable with MPT Ends (Use with FPT-Type Fittings)	¼"	50 ft	1	PC1321
Hybrid Field-Repairable with MPT Ends (Use with FPT-Type Fittings)	¼"	100 ft	1	PC1322
Hybrid Field-Repairable with MPT Ends (Use with FPT-Type Fittings)	¾"	50 ft	1	PC1339



HYBRID WITH MPT ENDS
PC1319, PC1320

Field Repairable End Fitting

- Field repairable hose ends are made with aircraft aluminum for easy on-site repair without hose clamps

Description	Hose Size	Qty.	ITEM #
Hybrid Hose Repair End Fitting	¼"	1	PC1341
Hybrid Hose Repair End Fitting	¾"	1	PC1337
Hybrid Hose Splicer	¼"	1	PC1338
Hybrid Hose Splicer	¾"	1	PC1340



HYBRID HOSE FIELD REPAIR KITS
END FITTING AND HOSE SPLICER KITS

Plugs & Couplers

Quick connect plugs and couplers are available in the most popular Industrial Interchange styles. Couplers are also available in Universal style.

Universal Couplers — push plug into coupler (no need to pull back on sleeve)

Type	Body Size	NPT Size	Pack Qty.	ITEM #
Female	¼"	¼" FPT	1	PC0900



FEMALE COUPLER
PC0900

Plugs — Industrial Interchange

Type	Body Size	Size	Pack Qty.	ITEM #
Male	¼"	¼" MPT	2	PC0479
Male	¼"	⅜" MPT	2	PC0480
Female	¼"	¼" FPT	2	PC0477
Female	¼"	⅜" FPT	2	PC0478
Push-on Barb	¼"	¼" LHB	1	PC0576
Push-on Barb	¼"	⅜" LHB	1	PC0577



MALE PLUG
PC0479, PC0480



FEMALE PLUG
PC0477,
PC0478



PLUG (PUSH-ON LOCKING BARB)
PC0576, PC0577

Couplers — Industrial Interchange

Type	Body Size	Size	Pack Qty.	ITEM #
Male	¼"	¼" MPT	1	PC0503
Male	¼"	⅜" MPT	1	PC0504
Female	¼"	¼" FPT	1	PC0501
Female	¼"	⅜" FPT	1	PC0502
Push-on Barb	¼"	¼" LHB	1	PC0505
Push-on Barb	¼"	⅜" LHB	1	PC0506



MALE COUPLER
PC0503, PC504



FEMALE COUPLER
PC0501, PC0502



COUPLER
(PUSH-ON LOCKING BARB)
PC0505, PC0506

Swivel Plugs & Couplers

- Allow easier access when working in corners and tight spaces
- Reduce fatigue
- Help prevent kinks and reduce stress on hose
- Provide strong and simple connection for pneumatic tools

Swivel Plugs — Industrial Interchange

Type	Body Size	NPT Size	Pack Qty.	ITEM #
Male	¼"	¼" MPT	2	PC1323
Male	¼"	⅜" MPT	2	PC1325



MALE SWIVEL PLUG
PC1323, PC1325

Swivel Couplers — Industrial Interchange

Type	Body Size	NPT Size	Pack Qty.	ITEM #
Female	¼"	¼" FPT	1	PC1328



FEMALE SWIVEL COUPLER
PC1328

Swivel Couplers — Universal

Type	Body Size	NPT Size	Pack Qty.	ITEM #
Female	¼"	¼" FPT	1	PC1330



FEMALE SWIVEL COUPLER
PC1330

(FPT) - Female Pipe Thread

(MPT) - Male Pipe Thread

(LHB) - Locking Hose Barb, no clamp required when used with SENCO Quick Couple Hose.

Air Hose Accessories

Splicer			
Description	Size	Pack Qty.	ITEM #
Push-On Barbed Hose Splicer	¼" LHB	2	PC0643



ProFlex Hose Fittings			
Description	Size	Pack Qty.	ITEM #
Brass Hose End	¼" MPT	1	PC0983
Brass Hose End and Splicer	¼" MPT	1	PC0987



Air Hose and Compressor Accessories

Tripod Manifold				
Description	Inlet Thread	Outlet Thread	Pack Qty.	ITEM #
3-Way Flat Manifold Industrial Interchange	¼" Plug	¼" Coupler	1	PC1138



Blow Gun			
Description	Inlet Thread	Pack Qty.	ITEM #
Air Blow Gun	¼" FPT	1	PC0489

(FPT) - Female Pipe Thread



Teflon® Thread Sealing Tape		
Description	Pack Qty.	ITEM #
½" x 260' Sealing Tape	1	PC0349



Regulators & Gauges

SENCO's assortment of filters and gauges are precision engineered to meet the demanding requirements of professional contractors. Be sure that your compressor is running at peak performance by using SENCO-certified replacement parts and accessories.

Air Regulation Accessories: Regulator with Gauge					
Description	Max PSI	Max Airflow	FPT Size	NPT Gauge	ITEM #
Mini Regulator with Gauge	250	14 SCFM	¼"	⅛"	PC0656
Regulator with Gauge	300	80 SCFM	⅜"	⅛"	PC0657
Back-Mount Pressure Gauge	160	—	—	⅛"	PC0057
Back-Mount Pressure Gauge	160	—	—	¼"	PC0051



Oils & Lubricants

Oils and Lubricants				
Description	Features	Size	Case Qty.	ITEM #
Pneumatic Tool Oil (½ pt)	<ul style="list-style-type: none"> Premium-grade oil with high-quality paraffin distillate stock Contains a carefully balanced rust and oxidation inhibitor with an effective anti-foaming additive 	8 oz	12	PC0101
Pneumatic Tool Oil (1 qt)	<ul style="list-style-type: none"> Premium-grade oil with high-quality paraffin distillate stock Contains a carefully balanced rust and oxidation inhibitor with an effective anti-foaming additive 	32 oz	12	PC0102
Pneumatic Tool Oil (1 gal)	<ul style="list-style-type: none"> Premium-grade oil with high-quality paraffin distillate stock Contains a carefully balanced rust and oxidation inhibitor with an effective anti-foaming additive 	128 oz	4	PC0103
Compressor Pump Oil (1 qt)	<ul style="list-style-type: none"> Premium-grade oil with high-quality naphthenic distillate stock Recommended for all oil-splash compressors Protects against corrosion Lubricates to extend part life 	32 oz	12	PC0344
Moisture Shield Tool Lubricant (1 qt)	<ul style="list-style-type: none"> For use in cold weather and/or high-moisture areas Protects against corrosion Lubricates to extend part life Special additive to minimize exhaust fog 	32 oz	12	PC1295
Tool Lubricant	<ul style="list-style-type: none"> Protects against corrosion Lubricates to extend part life Special additive to minimize exhaust fog 	4 oz	12	YB0123



Safety Glasses & Tool Belt Hooks

SENCO's safety glasses offer the ultimate in style and comfort while providing the highest level of eye protection, produced with a strong, lightweight polycarbonate lens that meets or exceeds ANSI Z87.1 and CE EN 166 safety standards.

Safety Glasses		
Description	Qty.	ITEM #
Wrap-Around Safety Glasses*	10-Case	PC1166



*Filters 99% of UVA and UVB rays. For indoor and outdoor use.



Tool Belt Hooks			
Description	Size	Qty.	ITEM #
Attaches to ¼" Air Fitting on Tool	Standard	1	PC0350
Attaches to ¼" Air Fitting on Tool	X-Wide	1	PC0629
Attaches to ⅜" Air Fitting on Tool	Standard	1	PC0351
Attaches to ⅜" Air Fitting on Tool	X-Wide	1	PC0630



Battery Systems

Compatible with all 18V Li-Ion Duraspin II and SENCO FUSION tools		
18V Li-Ion Battery 1.5 Amp Hour	Fits	
VB0155	DS212-18V DS215-18V DS312-18V DS215-XP All Fusion Models	 <ul style="list-style-type: none"> • 1.5 amp hour • High-quality reliable cells • Long storage life • Charges 80% in 15 minutes
18V Li-Ion Battery 3.0 Amp Hour	Fits	
VB0161	DS212-18V DS215-18V DS312-18V DS215-XP All Fusion Models	 <ul style="list-style-type: none"> • 3.0 amp hour • High-quality reliable cells • Long storage life • Drives up to 2X as many fasteners as VB0155

Charger System

Can be used interchangeably with SENCO VB0155, and VB0161 batteries		
Battery Charger	For use with	
VB0156	VB0155 VB0161	 <ul style="list-style-type: none"> • Battery charge indicators display charge status of your battery • Compatible with all SENCO 18V Li-Ion batteries

No-Mar Pads

No-Mar pads replacement, one per pack.



No-Mar Pads Fit	ITEM #
AF25, CF25	HF0064
AF41, CF41	HF0079
FIP11	HC0463
FIP15, FIP18	HC0506
FIP15Mg, FIP18Mg	HC0571
FIP23SXP, 23LXP, 21LXP	HC0729
FIP25XP	HF0064
FIP32*	HC0396
FIP32*	HC0401
FIP41XP, FIP42XP	HF0079
FN55AX	HF0113
FN65DA	HF0110
FP600-650 SERIES	HF0046, HC0253
FP601, FP602, FP651, FP652	HA0170
FP700 SERIES	HF0046, HC0253

No-Mar Pads Fit	ITEM #
GT65DA	HC0626
GT65RHA	HC0625
GT90CH	HA0200
GT90FRH	HA0201
SCN49	HC0536
SFN30, SFN40, SFNI	HF0079
SLS15, SLS18	HC0507
SLS15Mg, SLS18Mg	HC0572
SLS20, SLS20XP (K, L & R CROWNS)	HF0028
SLS20, SLS20XP (M CROWN)	HF0029
SLS25-L, SLS25XP-L	HF0028

*Refer to parts chart to identify desired safety element design.

Maintaining Your Tools

SENCO repair kits are designed to provide the parts normally needed to properly maintain and service your SENC0 tools.



Tool Model	Description	Item Code
FinishPro15, 18, 2N1	Repair Kit	YK0393
FinishPro15Mg, 18Mg	Repair Kit	YK0780
FinishPro16XP	Repair Kit A	YK0884
FinishPro16XP	Repair Kit B	YK0885
FinishPro18BMg	Repair Kit	YK0868
FinishPro21LXP, 23LXP	Repair Kit	YK0855
FinishPro23SXP	Repair Kit	YK0854
FinishPro25XP	Firing System Kit	YK0281
FinishPro25XP	Piston Stop Kit	YK0282
FinishPro32	Repair Kit	YK0394
FinishPro33Mg	Repair Kit	YK0787
FinishPro35Mg	Repair Kit	YK0788
FinishPro41XP, 42XP	Firing System Kit	YK0361
FinishPro41XP, 42XP	Piston Stop Kit	YK0362
FramePro601, 602, 651, 652	Repair Kit	YK0360
FramePro XP 701, 752, 702, 752	Firing System Kit	YK0243
FramePro XP 701, 752, 702, 752	Piston Stop Kit	YK0244
HN150, HN250	Repair Kit	BA0158
JoistPro150XP	Firing System Kit	YK0823
JoistPro150XP	Piston Stop Kit	YK0824
JoistPro250XP	Firing System Kit	YK0825
JoistPro250XP	Piston Stop Kit	YK0826
JoistPro250XP	Safety Upgrade Kit	YK0869
LS1XP	Repair Kit	YK0858
MW	Repair Kit	YK0371
NS20XP	Firing System Kit	YK0840
NS20XP	Piston Stop Kit	YK0841
NS20XP	Siding Safety Kit	HC0788
NS20BXP	Firing System Kit	YK0838
NS20BXP	Piston Stop Kit	YK0839
PAL57FXP	Repair Kit	YK0446
PS15XP, PS15RXP	Repair Kit	YK0784
PS15XP, PS15RXP	Repair Kit	YK0818
PS15XP, PS15RXP	Block Out Kit	YK883
PS15XP	Retrofit Kit - Solid Safety	YJ0044
PS15RXP	Retrofit Kit - Solid Safety	YJ0049
PS20XP	Repair Kit	YK0783
RoofPro™ 455XP	Firing System Kit	YK0424
RoofPro™ 445XP	Repair Kit	YK0865
RoofPro™ 445XP	Wear Guard Kit	YK0870
RoofPro™ 445XP	Gate Repair Kit	YK0871
RoofPro™ 455XP	Piston Stop Kit	YK0425
RoofPro™ 450XP	Repair Kit	YK0426
SC 1	Repair Kit	YK0370
SC 2	Repair Kit	YK0371
SCN48	Repair Kit	YK0769
SCN49	Repair Kit	YK0771
SCN60, SCN65	Seal Kit	YK0366

Tool Model	Description	Item Code
SFN1, SKS, SPS	Repair Kit	YK0376
SFN1, SKS, SPS	Retrofit Kit	YJ0035
SFN30	Repair Kit	YK0368
SFT10XP, SFT10XP D/L, SFT10XP LN	Piston Stop Kit	YK0802
SFT10XP, SFT10XP D/L, SFT10XP LN	Firing System Kit	YK0803
SFT10XP (AUTO)	Firing System Kit	YK0804
SFT10XP (AUTO D/L)	Firing System Kit	YK0804
SFT10XP (AUTO D/L)	Piston Stop Kit	YK0802
SFN1, SKSXP, SPS	Firing System Kit	YK0804
SFW09	Repair Kit	YK0775
SFW10XP	Piston Stop Kit	YK0321
SFW10XP	Firing System Kit	YK0322
SLP20	Repair Kit	YK0373
SLS15, SLS18	Repair Kit	YK0393
SLS15Mg, SLS18Mg	Repair Kit	YK0780
SLS20XP	Repair Kit	YK0372
SLS25XP	Piston Stop Kit	YK0291
SLS25XP	Firing System Kit	YK0359
SLS150Mg	Repair Kit	YK0852
SCP40XP	Firing System Kit	YK0444
SCP40XP	Piston Stop Kit	YK0445
SN901/902XP, FP325/325FRHXP	Firing System Kit	YK0444
SN901/902XP, FP325/325FRHXP	Piston Stop Kit	YK0445
SN951XP, SN952XP	Firing System Kit	YK0444
SN951XP, SN952XP	Piston Stop Kit	YK0768
SNS40	Repair Kit	YK0374
SNS41	Repair Kit	YK0423
SNS41 (Retrofit Kit)	Cap/Firing Valve	YJ0034
SNS41	Driver/Back Plate Upgrade	YK0794
SNS44XP	Firing System Kit	YK0421
SNS44XP	Piston Stop Kit	YK0422
SNS44XP	Driver/Back Plate Upgrade	YK0793
SNS45XP	Piston Stop Kit	YK0231
SNS50XP, SQS55XP	Seal Kit	YK0375
SNS200XP-BST	Firing System Kit	YK0838
SNS200XP-BST	Piston Stop Kit	YK0839
SNS200XP-BST	Wider Driver Kit	YK0873
SNS200XP	Firing System Kit	YK0840
SNS200XP	Piston Stop Kit	YK0841
SNS200XP	Block-Out Kit	YK0850
SNS200XP	Wider Driver Kit	YK0872
SNS200XP	Siding Safety Kit	HC0748
WC200XP	Piston Stop Kit	YK0784
WC200XP	Repair Kit	YK0783
WC200XP	Block-Out Kit	YK0786
WC200XP	Retrofit Kit - Solid Safety	YJ0037

Download SENC0 tool parts charts at www.senco.com to see a complete list of available individual parts.

BRIGHT BASIC

Bright Basic fasteners are an uncoated steel, which is commonly used in applications where corrosion protection is not required such as interior framing, finish and trim. These fasteners are not recommended for use in treated lumber or exterior applications.



GOOD
CORROSION
RESISTANCE

ELECTRO GALVANIZED

Electro Galvanized fasteners have a thin layer of zinc coating that helps corrosion resistance in mild weather conditions and in areas with lower humidity. Because of its minimal protective properties these fasteners are recommended for interior use in areas such as kitchens and bathrooms.



GOOD
CORROSION
RESISTANCE

HOT DIPPED GALVANIZED

Hot Dipped Galvanized nails have one ounce per square foot of zinc coating. The zinc coating on the nail acts as a barrier between the base steel and the elements, slowing the corrosion process. Ideal for preservative-treated wood and most exterior applications.



BETTER
CORROSION
RESISTANCE

304 STAINLESS STEEL

304 Stainless Steel contains 18% chromium and 8% nickel among other elements, making it resist most oxidizing acids and rust. An excellent choice for all types of environments and woods including exotic woods, cedar or redwood.

Recommended use: Exposure to wet conditions regularly and more than 5 miles away from a body of water.



BEST
CORROSION
RESISTANCE

BOX, CARTON & PALLET QUANTITIES - FASTENERS

Nails

Item Code	Boxes Per Carton	Boxes Per Skid
A100509	5	900
A100629	5	900
A100759	5	900
A101009	5	900
A101259	5	900
A101379	5	900
A101509	5	900
A102009	5	900
A109809	5	900
A109909	5	900
A201009	5	700
A201259	5	700
A201509	5	700
A202009	5	700
A209809	5	700
A209909	5	700
A301500	5	480
A301750	5	480
A302000	5	480
A302009	5	480
A302500	5	480
A302509	5	480
A401509	5	480
A402009	5	480
A402509	5	480
AX10EAA	24	720
AX11EAA	20	600
AX13EAA	16	480
AX15EAA	12	360
AX17EAA	10	300
AX18EAA	10	300
AX19EAA	8	240
AX21EAA	6	180
AX22EAA	6	180
AY10EAA	24	720
AY11EAA	20	600
AY13EAA	16	480
AZ08EAA	32	960
AZ11EAA	24	720
AZ13EAA	16	480
BD17APBC	N/A*	30
BE23AABF	N/A*	45
BG17AAAQ	N/A*	40
BG18AAAQ	N/A*	40
BK21BPBFN	N/A*	35
BK23BPBFN	N/A*	35
BK25BPBFN	N/A*	35
BL21APBF	N/A*	45
BT21APBF	N/A*	45
CZ10EAA	24	1440
CZ11EAA	24	1152
CZ13EAA	12	720
CZ15EAA	12	720
CZ16EAA	12	720
CZ17EAA	12	720
DA13EPBN	5	200
DA15AIA	5	200
DA15EABN	5	200
DA15EPBN	5	200
DA17AIA	5	200
DA17EABN	5	200
DA17EPBN	5	200
DA19AIA	4	160
DA19EABN	4	160
DA19EPBN	4	160
DA21EABN	4	160
DA21EGBN	1	90
DA21EPBN	4	160
DA23EPBN	3	120
DA25EAB	3	120
DA25EGB	N/A*	80

Nails (cont.)

Item Code	Boxes Per Carton	Boxes Per Skid
DA25EPB	3	120
ED23AABH	N/A*	60
EJ21ADBH	N/A*	40
EJ23ADBH	N/A*	40
EJ23ASBC	N/A*	24
EL19AGBH	N/A*	60
EL19ASBH	N/A*	60
EL20AABH	N/A*	60
EL20ASBH	N/A*	60
EL21AGBH	N/A*	60
EL21ASBH	N/A*	60
EL23AABH	N/A*	60
EL23AGBH	N/A*	60
EL23ASBC	N/A*	24
EL23ASBH	N/A*	60
EL25ASEC	N/A*	60
G524APBXN	N/A*	72
G524ASBXN	N/A*	72
G621ASBXN	N/A*	80
G624APBXN	N/A*	72
G624ASBXN	N/A*	72
GC21APBX	N/A*	80
GC23AHAK	N/A*	80
GC24APBX	N/A*	72
GC24ASBX	N/A*	72
GC25APBX	N/A*	72
GD21AABF	N/A*	40
GD21APBF	N/A*	40
GD24APBSN	N/A*	48
GD24ASBS	N/A*	45
GD25AABF	N/A*	40
GD25AABS	N/A*	48
GD25APBF	N/A*	40
GD25APBSN	N/A*	48
GE21APAX	N/A*	80
GE21ASBX	N/A*	80
GE24AGBK	N/A*	80
GE24APBX	N/A*	72
GE24ASBX	N/A*	72
GL21APBF	N/A*	40
GL21APBSN	N/A*	48
GL21ASBS	N/A*	45
GL24AABS	N/A*	48
GL24AGBF	N/A*	24
GL24AGBS	N/A*	72
GL24APBF	N/A*	40
GL24APBSN	N/A*	48
GL24ASBF	N/A*	40
GL24ASBS	N/A*	45
GT24APBF	N/A*	40
H527APBXN	N/A*	48
H528APBXN	N/A*	48
H627APBXN	N/A*	48
H627ASBXN	N/A*	48
HC27APBX	N/A*	48
HC27ASBX	N/A*	48
HD28APBX	N/A*	48
HD27APBF	N/A*	40
HD27APBSN	N/A*	48
HE27ASBX	N/A*	48
HF27EDB	N/A*	80
HF27EPAK	N/A*	40
HJ25ADBS	N/A*	45
HK27APBFN	N/A*	35
HL27AGBS	N/A*	54
HL27ASBF	N/A*	40
HL27ASBS	N/A*	40
HR22APAF	N/A*	40
HR74APAF	N/A*	40
K525APBXN	N/A*	72
K527APBXN	N/A*	48

Nails (cont.)

Item Code	Boxes Per Carton	Boxes Per Skid
K527APBXR	N/A*	80
K527ASBXN	N/A*	48
K528APBXN	N/A*	48
K528APBXR	N/A*	80
K528ASBXN	N/A*	48
K529APBXN	N/A*	48
K627ASBXN	N/A*	48
K628APBXN	N/A*	48
K628ASBXN	N/A*	48
K629ASBXN	N/A*	48
KC27AGBK	N/A*	80
KC27APBX	N/A*	48
KC27ASBX	N/A*	48
KC28AGBK	N/A*	80
KC28APBX	N/A*	48
KC28ASBX	N/A*	48
KC29APBX	N/A*	48
KC29ASBX	N/A*	48
KC31APBX	N/A*	40
KD25AABS	N/A*	45
KD25APBF	N/A*	40
KD25APBSN	N/A*	48
KD27APBF	N/A*	40
KD27APBSN	N/A*	48
KD27ASBF	N/A*	24
KD27ASBS	N/A*	40
KD28AGBS	N/A*	54
KD28APBF	N/A*	40
KD28APBSN	N/A*	48
KD28ASBF	N/A*	24
KD28ASBS	N/A*	40
KD29APBF	N/A*	40
KD29APBSN	N/A*	48
KD29ASBS	N/A*	40
KJ17AEBD	N/A*	100
KJ17AHBD	N/A*	900
KT25APBF	N/A*	40
LC29APBX	N/A*	48
M001000	20	960
M001001	16	768
M001002	6	480
M001003	6	480
M001004	6	384
M001005	6	384
M001007	6	288
M002261	N/A*	100
M002262	N/A*	100
M002263	N/A*	100
M002264	N/A*	100
M002265	N/A*	100
M002266	N/A*	100
M003011	N/A*	24
M003101	N/A*	56
M003103	N/A*	56
M003104	N/A*	48
M003105	N/A*	40
M003106	N/A*	40
MD17AJBD	N/A*	100
MD25AHBD	N/A*	100
MD25AJBD	N/A*	100
MD27APBSN	N/A*	36
MD28APBSN	N/A*	36
MD34APBF	N/A*	36
ND25AQBD	N/A*	100
P13BGBN	N/A*	60
RH15EAA	6	480
RH21EAA	6	384
RH25EAA	6	288
RW17BPE	10	510
RW19BPE	10	510
RW21BGE	10	510

Nails (cont.)

Item Code	Boxes Per Carton	Boxes Per Skid
RW17BPE	10	510
RW19BPE	10	510
RW21BGE	10	510
RW21BPE	10	510
SE15APB	N/A*	40
SE15APBH	N/A*	40
SE17APBH	N/A*	40
SE19APB	N/A*	40
W3050YXS	5	250
W3075YXC	5	250
W3100YXC	5	250
W3125YXC	5	250
ZX10EAA	12	720
ZX13EAA	12	576
ZX16EAA	10	360
ZX18EAA	10	360
ZX21EAA	10	240

Staples

Item Code	Boxes Per Carton	Boxes Per Skid
A04BAAN	48	1152
A06BABN	6	216
A06BABP	8	192
A08BAB	12	288
A08BABP	8	192
A800629	5	600
A800759	5	600
A801009	5	600
A801259	5	600
A801509	5	600
A809909	5	600
B04BAAPN	8	192
B06BAAP	4	96
B08BAAP	4	96
C02BAAPN	8	192
C03BAAPN	8	192
C03BGAN	8	272
C04BAAP	8	192
C04BGAN	8	272
C05BAAPN	8	192
C06BAAP	4	96
C06BGA	20	480
C06BHA	20	640
C07BAAPN	4	96
C08BAAP	4	96
C10BAAP	4	96
D10BABN	6	216
D10BABPN	8	192
E06BAA	20	640
E08BAA	16	512
E10BAA	25	800
F04BAAN	12	384
F04BAAP	8	192
F05BAAP	4	96
F06BAA	10	300
F06BAAP	4	96
F06BGA	10	300
F08BAAN	8	240
F08BAAP	4	96
G04BAAN	24	480
G06BABN	25	800
G08BAB	20	640
H06BAA	20	480
J06BAA	15	240
J08BAAN	9	288
J10BAAN	8	160
K11BAB	6	240
K12BAB	10	400

*Product is shipped in the item box, not in a master shipping carton.

BOX, CARTON & PALLET QUANTITIES - FASTENERS

Staples (cont.)

Item Code	Boxes Per Carton	Boxes Per Skid
K13BABN	12	384
L06BAB	10	360
L07BABP	N/A*	112
L08BAB	8	288
L10BABN	12	432
L10BHA	12	432
L10HABN	12	432
L11BAB	10	360
L11BGA	10	360
L11BRB	10	360
L11HAB	10	360
L11HBB	10	180
L12BAB	10	360
L12BQB	10	360
L13BABN	8	288
L13BRBN	8	288
L13BRBP	N/A*	36
L13HABN	8	288
L14BAB	6	216
L14BGA	6	216
L14BRB	6	216
L15BAB	6	216
L15BRB	6	216
L17BAB	6	216
M06BABN	7	224
M08BAB	6	192
M10BABN	9	288
M10BRBN	9	288
M11BABN	8	256
M11BRBN	8	256
M12BAB	6	192
M13BAB	6	192
M13BRB	6	192
M15BAB	N/A*	60
M17BAB	N/A*	48
M004092	N/A*	180
N08BABN	6	192
N08BBBN	6	192
N08FBB	6	192
N10BAB	6	192
N11BAB	6	192
N11BRB	6	192
N11FBB	6	192
N12BABN	6	192
N12FABN	5	160
N13BAB	4	128
N13BRB	4	128
N13FAB	4	128
N14BAB	N/A*	56
N14BRB	N/A*	56
N15BAB	N/A*	56
N15BGB	N/A*	165
N15BRB	N/A*	56
N15FAB	N/A*	56
N16BAB	N/A*	56
N16BRB	N/A*	56
N17BAB	N/A*	48
N17BGB	N/A*	165
N17BPE	N/A*	48
N17BRB	N/A*	48
N18BAB	N/A*	48
N18BRB	N/A*	48
N19BAB	N/A*	40
N19BGBN	N/A*	130
N19BPE	N/A*	40
N19BRB	N/A*	40
N21BAB	N/A*	40
N21BGBN	N/A*	120
N21BPE	N/A*	40
N21BRB	N/A*	40
O15BRBBN	N/A*	56

Staples (cont.)

Item Code	Boxes Per Carton	Boxes Per Skid
O16BRBBN	N/A*	70
O17BRBBN	N/A*	56
O18BRBBN	N/A*	56
O19BRBBN	N/A*	70
P06BAA	N/A*	60
P08BABT	N/A*	60
P10BAB	N/A*	60
P10BPE	N/A*	60
P10FAB	N/A*	60
P11BAB	N/A*	50
P11BPE	N/A*	50
P12BAB	N/A*	40
P13BAB	N/A*	40
P13BGBN	N/A*	60
P13BPE	N/A*	40
P15BAB	N/A*	30
P15BPE	N/A*	30
P17BAB	N/A*	30
P19BAB	N/A*	40
P21BAB	N/A*	40
Q15BAB	N/A*	64
Q17BAB	N/A*	64
Q17BRB	N/A*	64
Q19BAB	N/A*	64
Q19BGBN	N/A*	130
Q19BRB	N/A*	64
Q21BAB	N/A*	56
Q21BRB	N/A*	56
Q23BRB	N/A*	48
Q25BAB	N/A*	48
Q25BRB	N/A*	48
R08BAB	12	384
R10BAB	12	480
R11BAB	12	480
R13BAB	12	480
W10BAB	10	400

Staples— Specialty

Item Code	Boxes Per Carton	Boxes Per Skid
X04NRA	N/A*	224
X06NRA	N/A*	224
X08NRA	N/A*	224
Y05BFA	10	320
Y07BFA	8	256
Y09BFAN	6	180

Screws

Item Code	Tubs/Boxes Per Carton	Tubs Per Skid
O6A125P	6	144
O6A125PB	N/A*	72
O6A162P	6	144
O6A162PB	N/A*	72
O6A162W	6	144
O6B125P	6	144
O6B125PB	N/A*	72
O6B162P	6	144
O6B162PB	N/A*	72
O6C125CB	N/A*	72
O6C125PB	N/A*	72
O6C125WK	6	144
O6C162CB	N/A*	72
O6C162PB	N/A*	72
O6C162WK	6	240
O6C200CB	N/A*	48

Screws (cont.)

Item Code	Tubs/Boxes Per Carton	Tubs Per Skid
O6C200PB	N/A*	48
O7A200P	6	144
O7Q100PB	N/A*	72
O7Q125PB	N/A*	72
O7Q125PBQ	N/A*	72
O8A250PK	6	192
O8C300WK	6	144
O8D175W	6	144
O8D200W	6	144
O8D250S	6	144
O8D250W	6	144
O8D250WK	6	192
O8D300W	6	144
O8F150Y	6	144
O8F175Y	6	144
O8F175YKX	6	240
O8F200Y	6	144
O8F200YBTHSS	N/A*	48
O8F250Y	6	144
O8F300Y	6	144
O8G100CBWFDS	N/A*	72
O8G150CTLDSS	6	144
O8G162CTWFWS	6	144
O8G200CKLFPS	6	192
O8G200WTWFWS	6	144
O8G250WWK	6	192
O8L125CBLCTS	N/A*	72
O8L175YB	N/A*	72
O8M050CTRFDP	6	144
O8M050CTRFSP	6	144
O8M100CBPDSS	N/A*	72
O8R250S	6	144
O8R250W	6	144
O8R300W	6	144
O8S250W003	6	144
O8S250W497	6	144
O8S250W592	6	144
O8T125W	6	144
O8T150WBWFDS	N/A*	72
O8T200W	6	144
O8X125CBACTS	N/A*	72
O8X125CKADDS	6	240
O8X200CKADDS	6	192
O9D300S	6	144
10G125CBWFDS	N/A*	72
10G162CTWFWS	6	144
10M075CDK	6	240
10M075CTMFDS	6	144
10M075YKFT4X	6	240
10M075YLFT4X	N/A*	48
10M075YTFDX	6	144
10M100CKMFDS	6	240
12G175YKLFAX	6	240
12G200YKLFCCX	6	192
12G250YKLFCCX	6	192
12M087YKFF4X	6	240
12M100YKFF3X	6	240

*Product is shipped in the item box, not in a master shipping carton.

Tools: DuraSpin (Corded)

Model	Item #	Page
DS232-AC	7U0001N	4
DS235-AC	7T0001N	4
DS332-AC	7V0001N	4
DS425AC	6W0012N	5
DS440AC	6W0011N	5
SG2510	6X0002N	7
SG4100	6X0004N	7

Tools: DuraSpin (Cordless)

Model	Item #	Page
DS212-18V	7X0001N	3
DS215-18V	7W0001N	3
DS312-18V	7Y0001N	3

Tools: Fusion (Cordless)

Model	Item #	Page
F-15	5N0001N	15
F-16S	6U0001N	15
F-18	6E0001N	15

Tools: Pneumatic

Model	Item #	Page
A11 Hammer Stapler	PC0700	50
A20 Hand Nailer	PC0781	36
BC58	4A0001N	50
DFXP	8H0001N	56
F75LXP	8J0002N	56
F75SXP	8J0001N	56
FinishPro™16XP	9S0001N	22
FinishPro™18BMg	9B0001N	20
FinishPro™18Mg	1U0021N	20
FinishPro™21LXP	8M0001N	20
FinishPro™23LXP	8L0001N	19
FinishPro™23SXP	8F0001N	19
FinishPro™25XP	760102N	21
FinishPro™30XP	9P0002N	23
FinishPro™35Mg	6G0001N	23
FinishPro™42XP	4G0001N	23
FramePro™325FRHXP	4H0101N	34
FramePro™325XP	4Z0101N	33
FramePro™701XP	2H0133N	33
FramePro™702XP	2K0103N	34
FramePro™751XP	2J0103N	33
FramePro™752XP	2F0103N	34
JoistPro™150XP	7L0001N	36
JoistPro™250XP	6K0001N	36
LS1XP	8N0001N	20
Mini Hand Nailer	PC1195	36
NS20BST	9Y0001N	62
NS20XP	9X0001N	38
PalletPro™100XP	5L0001N	55
PalletPro™130XP	5M0001N	55
PalletPro™57FXP	4L0001N	55
PS15RXP	9U0001N	50
PS15XP	9T0001N	37

Tools: Pneumatic (Cont.)

Model	Item #	Page
PS20XP	9W0001N	37
RoofPro™445XP	8V0001N	49
SC1XP Senclamp®	220101N	25
SC2 Sencor®	470001N	25
SCN49XP	5J0001N	49
SCN60XP	520101N	35
SCN65 XP (Toenail Safety)	540104N	35
SCN65XP (Flat Safety)	540101N	35
SCP40XP	7J0001N	37
SFT10XP - 20 Ga. E Wire - Standard	650031N	61
SFT10X - 20 Ga. F Wire - Standard	650041N	61
SFT10XP - 20 Ga. G Wire - Standard	650051N	61
SFT10XP - 22 Ga C Wire - Standard	650021N	61
SFT10XP - 22 Ga. A/D Wire - Auto	650101N	61
SFT10XP - 22 Ga. A/D Wire - Standard	650001N	61
SFT10XP - 22 Ga. B Wire - Standard	650011N	61
SFT10XP - 22 Ga. C Wire - Auto	650121N	61
SFT10XP - Dbl. Length Mag. 20 Ga. F Wire - Auto	650341N	61
SFT10XP - Dbl. Length Mag. 20 Ga. G Wire - Auto	650351N	61
SFT10XP - Dbl. Length Mag. 20 Ga. G Wire - Standard	650251N	61
SFT10XP - Dbl. Length Mag. 20 Ga. H Wire - Auto	650361N	61
SFT10XP - Dbl. Length Mag. 22 Ga. B Wire - Auto	650311N	61
SFT10XP - Dbl. Length Mag. 22 Ga. B Wire - Standard	650211N	61
SFT10XP - Dbl. Length Mag. 22 Ga. C Wire - Auto	650321N	61
SFT10XP - Dbl. Length Mag. 22 Ga. C Wire - Standard	650221N	61
SFT10XP - Long Nose 22 Ga. C Wire - Standard	650421N	61
SFW09	4C0001N	62
SHF200	8D0001N	67
SKSXP-L	300120N	24
SKSXP-M	300152N	24
SKSXP-N	300184N	24
SLP20XP	430101N	21
SLS150Mg	8C0001N	25
SLS18Mg	1W0021N	25
SLS20XP-HF	490021N	67
SLS20XP-K	490101N	24
SLS20XP-L	490103N	24
SLS20XP-L SENCOMATIC	490015N	24
SLS20XP-L W/CASE	490105N	24
SLS20XP-M	490107N	24
SLS20XP-R	490111N	24
SLS25XP-L	820103N	24
SLS25XP-M	820107N	24
SNS41	3L0003N	38
SQS55XP	660101N	38

Tools: Compressors & Kit

Model	Item #	Page
PC0947	PC0947	71
PC0968	PC0968	71
PC1010	PC1010	71
PC1010N	PC1010N	71
PC1131	PC1131	71
PC1280	PC1280	71

ITEM CODE INDEX

Fasteners: Nails

Item #	Page
A100509	26
A100629	26
A100759	26
A101009	26
A101259	26
A101379	26
A101509	26
A102009	26
A109809	26
A109909	26
A201009	16, 26
A201259	16, 26
A201509	16, 26
A202009	16, 26
A209809	16, 26
A209909	16, 26
A301500	17, 28
A301750	17, 28
A302000	17, 28
A302009	17, 28
A302500	17, 28
A302509	17, 28
A401509	16, 27
A402009	16, 27
A402509	16, 27
AX10EAA	16, 26
AX11EAA	16, 26
AX13EAA	16, 26
AX15EAA	16, 26
AX17EAA	16, 26
AX18EAA	16, 26
AX19EAA	16, 26
AX21EAA	16, 26
AX22EAA	16, 26
AY10EAA	16, 27
AY11EAA	16, 27
AY13EAA	16, 27
AZ08EAA	27
AZ11EAA	27
AZ13EAA	27
BD17APBC	51
BE23AABF	43, 58
BG17AAAQ	44
BG18AAAQ	44
BK21BPFBN	44, 59
BK23BPFBN	44, 59
BK25BPFBN	44, 59
BL21APBF	43, 58
BT21APBF	42, 43, 58
CZ10EAA	26
CZ11EAA	26
CZ13EAA	26
CZ15EAA	26
CZ16EAA	26
CZ17EAA	26
DA13EPBN	17, 28
DA15AIA	17, 28
DA15EABN	17, 28
DA15EPBN	17, 28
DA17AIA	17, 28
DA17EABN	17, 28
DA17EPBN	17, 28
DA19AIA	17, 28
DA19EABN	17, 28
DA19EPBN	17, 28
DA21EABN	28
DA21EGBN	17, 28
DA21EPBN	17, 28
DA23EPBN	17, 28
DA25EAB	17, 28

Fasteners: Nails (cont.)

Item #	Page
DA25EGB	17, 28
DA25EPB	17, 28
ED23AABH	51, 57
EJ21ADBH	51, 57
EJ23ADBH	51
EJ23ASBC	51
EL19AGBH	52, 58
EL19ASBH	52, 58
EL20AABH	52, 58
EL20ASBH	52, 58
EL21AGBH	52, 58
EL21ASBH	52, 58
EL23AABH	52, 58
EL23AGBH	52, 58
EL23ASBC	52
EL23ASBH	52, 58
EL25ASEC	52
G524APBXN	39
G524ASBXN	39
G621ASBXN	39
G624APBXN	39
G624ASBXN	39
GC21APBX	40
GC23AHAK	40
GC24APBX	40
GC24ASBX	40
GC25APBX	40
GD21AABF	43, 57
GD21APBF	43, 57
GD24APBSN	41
GD24ASBS	41
GD25AABF	43, 57
GD25AABS	41
GD25APBF	43, 57
GD25APBSN	41
GE21APAX	40
GE21ASBX	40
GE24AGBK	40
GE24APBX	40
GE24ASBX	40
GL21APBF	43, 58
GL21APBSN	42
GL21ASBS	42
GL24AABS	42
GL24AGBF	43, 58
GL24AGBS	42
GL24APBF	43, 58
GL24APBSN	42
GL24ASBF	43, 58
GL24ASBS	42
GT24APBF	42, 58
H527APBXN	39
H528APBXN	39
H627APBXN	39
H627ASBXN	39
HC27APBX	40
HC27ASBX	40
HC28APBX	40
HD27APBF	43, 57
HD27APBSN	41
HE27ASBX	40
HF27EDB	40
HF27EPAK	40
HJ25ADBS	41
HK27APBFB	44, 59
HL27AGBS	42
HL27ASBF	43, 58
HL27ASBS	42
HR22APAF	44
HR74APAF	44

Fasteners: Nails (cont.)

Item #	Page
K525APBXN	39
K527APBXN	39
K527APBXR	39
K527ASBXN	39
K528APBXN	39
K528APBXR	39
K528ASBXN	39
K529APBXN	39
K627ASBXN	39
K628APBXN	39
K628ASBXN	39
K628APBXR	39
KC27AGBK	40
KC27APBX	40
KC27ASBX	40
KC28AGBK	40
KC28APBX	40
KC28ASBX	40
KC29APBX	40
KC29ASBX	40
KC31APBX	40
KD25AABS	41
KD25APBF	43, 57
KD25APBSN	41
KD27APBF	43, 57
KD27APBSN	41
KD27ASBF	43, 57
KD27ASBS	41
KD28AGBS	41
KD28APBF	43, 57
KD28APBSN	41
KD28ASBF	43, 57
KD28ASBS	41
KD29APBF	43, 57
KD29APBSN	41
KD29ASBS	41
KJ17AEBD	45
KJ17AHBD	45
KT25APBF	42, 58
LC29APBX	40
M001000	16, 27
M001001	16, 27
M001002	16, 27
M001003	16, 27
M001004	16, 27
M001005	16, 27
M001007	16, 27
M002261	45
M002262	45
M002263	45
M002264	45
M002265	45
M002266	45
M003011	44
M003101	51
M003103	51
M003104	51
M003105	51
M003106	51
MD17AJBD	45
MD25AHBD	45
MD25AJBD	45
MD27APBSN	41
MD28APBSN	41
MD34APBF	43, 57
ND25AQBD	45
P13BGBN	53
RW17BPE	68
RW19BPE	68
RW21BGE	68

Fasteners: Nails (cont.)

Item #	Page
RW21BPE	68
SE15APB	52
SE15APBH	52, 58
SE17APBH	52, 58
SE19APB	52
W3050YXS	45
W3075YXC	45
W3100YXC	45
W3125YXC	45
ZX10EAA	26
ZX13EAA	26
ZX16EAA	26
ZX18EAA	26
ZX21EAA	26

Fasteners: Staples

Item #	Page
A04BAAN	63
A06BABN	63
A06BABP	63
A08BAB	63
A08BABP	63
A800629	29
A800759	29
A801009	29
A801259	29
A801509	29
A809909	29
B04BAAPN	63
B06BAAP	63
B08BAAP	63
B08BAPN	63
C02BAAPN	63
C03BAAPN	63
C03BGAN	63
C04BAAP	63
C04BGAN	63
C05BAAPN	63
C06BAAP	63
C06BGA	63
C06BHA	63
C07BAAPN	63
C08BAAP	63
C10BAAP	63
D10BABN	63
D10BABPN	63
E06BAA	64
E08BAA	64
E10BAA	64
F04BAAN	64
F04BAAP	64
F05BAAP	59, 64
F06BAA	59, 64
F06BGA	59, 64
F08BAAN	59, 64
F08BAAP	59, 64
G04BAAN	64
G06BABN	64
G08BAB	64
H06BAA	53, 64
J06BAA	59
J08BAAN	59
J10BAAN	59
K11BAB	29
K12BAB	29
K13BABN	29

Fasteners:
Staples (cont.)

Item #	Page
L06BAB	29
L07BABP	29
L08BAB	29
L10ABAN	29
L10BHA	29
L10HABN	29
L11BAB	29
L11BGA	29
L11BRB	29
L11HAB	29
L11HBB	29
L12BAB	29
L12BQB	29
L13BABN	29
L13BRBN	29
L13BRBP	29
L13HABN	29
L14BAB	29
L14BGA	29
L14BRB	29
L15BAB	29
L15BRB	29
L17BAB	29
M06BABN	30
M08BAB	30
M10BABN	30
M10BRBN	30
M11BABN	30
M11BRBN	30
M12BAB	30
M13BAB	30
M13BRB	30
M15BAB	30
M17BAB	30
M004092	53
N08BABN	30, 47, 65
N08BBBN	30, 47, 65
N08FBB	30, 47, 65
N10BAB	30, 47, 65
N11BAB	30, 47, 65
N11BRB	30, 47, 65
N11FBB	30, 47, 65
N12BABN	30, 47, 65
N12FABN	30, 47, 65
N13BAB	30, 47, 65
N13BRB	30, 47, 65
N13FAB	30, 47, 65
N14BAB	30, 47, 65
N14BRB	30, 47, 65
N15BAB	30, 47, 65
N15BGB	30, 47, 65
N15BRB	30, 47, 65
N15FAB	30, 47, 65
N16BAB	30, 47, 65
N16BRB	30, 47, 65
N17BAB	30, 47, 65
N17BGB	30, 47, 65
N17BPE	30, 47, 65
N17BRB	30, 47, 65
N18BAB	30, 47, 65
N18BRB	30, 47, 65
N19BAB	30, 47, 65
N19GBN	30, 47, 65
N19BPE	30, 47, 65
N19BRB	30, 47, 65
N21BAB	30, 47, 65
N21BGBN	30, 47, 65
N21BPE	30, 47, 65
N21BRB	30, 47, 65
O15BRBBN	46, 65

Fasteners:
Staples (cont.)

Item #	Page
O16BRBBN	46, 65
O17BRBBN	46, 65
O18BRBBN	46, 65
O19BRBBN	46, 65
P06BAA	46, 53
P08BABT	46, 53
P10BAB	46, 53
P10BPE	46, 53
P10FAB	46, 53
P11BAB	46, 53
P11BPE	46, 53
P12BAB	46, 53
P13BAB	46, 53
P13BGBN	46
P13BPE	46, 53
P15BAB	46, 53
P15BPE	46, 53
P17BAB	46, 53
P19BAB	46
P21BAB	46
Q15BAB	47
Q17BAB	47
Q17BRB	47
Q19BAB	47
Q19GBN	47
Q19BRB	47
Q21BAB	47
Q21BRB	47
Q23BRB	47
Q25BAB	47
Q25BRB	47
R08BAB	29
R10BAB	29, 68
R11BAB	29, 68
R13BAB	29, 68
W10BA	63

Fasteners:
Staples — Specialty

Item #	Page
X04NRA	31
X06NRA	31
X08NRA	31
Y05BFA	31
Y07BFA	31
Y09BFAN	31

Fasteners:
Screws

Item #	Page
06A125P	8
06A125PB	8
06A162P	8
06A162PB	8
06A162W	8
06B125P	8
06B125PB	8
06B162P	8
06B162PB	8
06C125CB	8
06C125PB	8
06C125WK	8
06C162CB	8

Fasteners:
Screws (cont.)

Item #	Page
06C162PB	8
06C162WK	8
06C200CB	8
06C200PB	8
07A200P	8
07Q100PB	9
07Q125PB	9
07Q125PBQ	9
08A250PK	8
08C300WK	8
08D175W	9
08D200W	9
08D250S	9
08D250W	9
08D250WK	9
08D300W	9
08F150Y	8
08F175Y	8
08F175YKX	8
08F200Y	8
08F200YBTHSS	8
08F250Y	8
08F300Y	8
08G100CBWFDS	9
08G150CTLDSS	9
08G162CTWFWS	9
08G200CKLFPS	9
08G200WTFWFS	9
08G250WWK	9
08L125CBLCTS	8
08L175YB	8
08M050CTRFDP	11
08M050CTRFSP	11
08M100CBPDSS	11
08R250S	10
08R250W	10
08R300W	10
08S250W003	10
08S250W497	10
08S250W592	10
08T125W	9
08T150WBWFDS	9
08T200W	9
08X125CBACTS	11
08X125CKADDS	11
08X200CKADDS	11
09D300S	9
10G125CBWFDS	9
10G162CTWFWS	9
10M075CDK	11
10M075CTMFDS	10
10M075YKFT4X	10
10M075YLFT4X	10
10M075YTFDX	10
10M100CKMFDS	10
12G175YKLFAX	9
12G200YKLFAX	9
12M087YKFF4X	10
12M100YKFF3X	10

Accessories:
Screw System

Item #	Page
6W0001N	6
6W0003N	6
ADP009	12
ADP019	12
ADP020	12
EA0272	12
EA0279	12
EA0297	12
EA0297N	12
EA0298	12
EA0298N	12
EA0299	12
EA0299N	12
EA0300	12
EA0301	12
EA0301N	12
EA0302	12
EA0308	12
EA0311	12
EA0312	12
EA0312N	12
EA0313	12
EA0313N	12
EA0314	12
EA0315	12
EA0315N	12
EA0316	12
EA0317	12
EA0318	12
EA0319	12
EA0320	12
EA0321	12
EA0322	12
FA0334	13
FB0155	13
FB0157	13
FB0159	13
FC0822	13
FC0878	13
FC0887	13
FC0895	13
FC0983	13
MB0173	12
MB0174	12

Accessories:
Pneumatic

Item #	Page
HA0308	51
HCO788	38, 62
MA0013	51
NPC03	37
PC0051	75
PC0057	75
PC0064	73
PC0065	73
PC0101	76
PC0102	76
PC0103	76
PC0344	76
PC0349	75
PC0350	76
PC0351	76
PC0477	74
PC0478	74

Accessories: Pneumatic (cont.)

Item #	Page
PC0479	74
PC0480	74
PC0489	75
PC0501	74
PC0502	74
PC0503	74
PC0504	74
PC0505	74
PC0506	74
PC0576	74
PC0577	74
PC0629	76
PC0630	76
PC0643	75
PC0656	75
PC0657	75
PC0900	74
PC0977	73
PC0978	73
PC0979	73
PC0983	75
PC0987	75
PC1138	75
PC1152	73
PC1166	76
PC1295	76
PC1319	73
PC1320	73
PC1321	73
PC1322	73
PC1323	74
PC1325	74
PC1328	74
PC1330	74
PC1337	73
PC1338	73
PC1339	73
PC1340	73
PC1341	73
SWM125B	37
YB0123	76
YJ0042	33
YJ0043	33
YJ0044	37
YJ0055	33
YK0887	38

Accessories: No-Mar Pads (cont.)

Item #	Page
HC0401	77
HC0463	77
HC0506	77
HC0507	77
HC0536	77
HC0571	77
HC0572	77
HC0625	77
HC0626	77
HC0729	77
HF0028	77
HF0029	77
HF0046	77
HF0064	77
HF0079	77
HF0110	77
HF0113	77







Accessories: Battery & Charger Systems

Item #	Page
VB0155	13, 15, 77
VB0156	13, 15, 77
VB0161	13, 15, 77

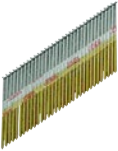

Accessories: No-Mar Pads

Item #	Page
HA0170	77
HA0200	77
HA0201	77
HC0253	77
HC0396	77





FINISH & WOODWORKING

15 GA	16 GA	18 GA	21 GA		
					
Pg. 28	Pg. 27	Pg. 27	Pg. 26		
23 GA	19 GA	18 GA	16 GA	SENCLAMP	SENCLAMP
					
Pg. 26	Pg. 29	Pg. 29-30	Pg. 30	Pg. 31	Pg. 31

FRAMING, SHEATHING & SUBFLOORS

34° Prohead	34°	20°	COIL	METAL	CONCRETE	15 GA	16 GA	17 GA
								
Pg. 39	Pg. 40	Pg. 41-42	Pg. 42-44	Pg. 45	Pg. 45	Pg. 47	Pg. 46-47	Pg. 46

ROOFING, SIDING & FENCING

ROOFING	16 GA WIDE CROWN	FELT CAP & STAPLE	20 GA	WIRE WELD	PLASTIC WOUND
					
Pg. 51-52	Pg. 53	Pg. 53	Pg. 53	Pg. 51-52	Pg. 51-52

FLOORING

CLEAT	19 GA
	
Pg. 68	Pg. 68



PALLETS & CRATING

15° SMOOTH	15° RING	15° SCREW	20 GA	18 GA
				
Pg. 57	Pg. 58	Pg. 59	Pg. 59	Pg. 59

UPHOLSTERY & FURNITURE

22 GA	21 GA	20 GA	17 GA	16 GA
				
Pg. 63	Pg. 63	Pg. 64	Pg. 65	Pg. 65

DURASPIN AUTO-FEED SCREW SYSTEMS



DRYWALL	WOOD TO WOOD	WOOD TO STEEL	UNDERLAYMENT	DECKS/DOCKS	METAL TO METAL
					
Pg. 8	Pg. 8	Pg. 9	Pg. 9	Pg. 9-10	Pg. 10

REFERENCE

FUSION CORDLESS

15 GA - 34°	16 GA	18 GA
		
Pg. 17	Pg. 16	Pg. 16

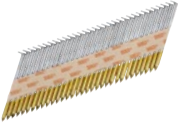
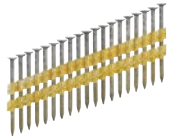
HOT DIPPED GALVANIZED

34°	20°	15° COIL
		
Pg. 39, 40 & 45	Pg. 41-42	Pg. 43, 51, 52, 57, 58

304 STAINLESS STEEL

15 GA	34°	20°	15° COIL	15 GA		
						
Pg. 17 & 28	Pg. 40	Pg. 41-42	Pg. 43, 52, 58	Pg. 47		
16 GA	18 GA	20 GA	22 GA	#2 FLAT HEAD	#2 TRIM HEAD	CLEAT
						
Pg. 46, 47, 53, 65	Pg. 29	Pg. 64	Pg. 63	Pg. 9	Pg. 10	Pg. 68

DURASPIN AUTO-FEED SCREW SYSTEMS

DS215-18V 7W0001N  Pg. 3	DS212-18V 7X0001N  Pg. 3	DS312-18V 7Y0001N  Pg. 3	DS235-AC 7T0001N  Pg. 4	DS232-AC 7U0001N  Pg. 4	DS332-AC 7V0001N  Pg. 4
DS425AC 6W0012N  Pg. 5		DS440AC 6W0011N  Pg. 5		DS220 6W0001N  Pg. 6	
DS320 6W0003N  Pg. 6				SG2510 6X0002N  Pg. 7	SG4100 6X0004N  Pg. 7

Fasteners: see pages 8 - 11

FUSION CORDLESS

F-18 6E0001N  Pg. 15	F-16S 6U0001N  Pg. 15	F-15 5N0001N  Pg. 15
---	--	---

Fasteners: see pages 16-17

FINISH & WOODWORKING

FinishPro23SXP 8F0001N	FinishPro23LXP 8L0001N	FinishPro21LXP 8M0001N	LS1XP 8N0001N	FinishPro18Mg 1U0021N	FinishPro18BMg 9B0001N	SLP20XP 430101N
						
Pg. 19	Pg. 19	Pg. 20	Pg. 20	Pg. 20	Pg. 20	Pg. 21
FinishPro25XP 760102N	FinishPro16XP 9S0001N	FinishPro30XP 9P0002N	FinishPro35Mg 6G0001N	FinishPro42XP 4G0001N	SLS20XP SEE SPECIFICATIONS	
						
Pg. 21	Pg. 22	Pg. 23	Pg. 23	Pg. 23	Pg. 24	
SLS25XP SEE SPECIFICATIONS	SKSXP SEE SPECIFICATIONS	SLS150Mg 8C0001N	SLS18Mg 1W0021N	SC1XP 220101N	SC2 470001N	
						
Pg. 24	Pg. 24	Pg. 25	Pg. 25	Pg. 25	Pg. 25	

Fasteners: see pages 26-31

FRAMING, SHEATHING & SUBFLOORS

FramePro325XP 4Z0101N	FramePro701XP 2H0133N	FramePro751XP 2J0103N	FramePro325FRHXP 4H0101N	FramePro702XP 2K0103N	FramePro752XP 2F0103N
					
Pg. 33	Pg. 33	Pg. 33	Pg. 34	Pg. 34	Pg. 34
SCN60XP 520101N	SCN65XP 540101N/540104N	JoistPro150XP 7L0001N	JoistPro250XP 6K0001N	Mini Hand Nailer PC1195	A20 Hand Nailer PC0781
					
Pg. 35	Pg. 35	Pg. 36	Pg. 36	Pg. 36	Pg. 36

Fasteners: see pages 39-44

SCP40XP 7J0001N	PS15XP 9T0001N	PS20XP 9W0001N	SNS41 3L0003N	NS20XP 9X0001N	SQS55XP 660101N
					
Pg. 37	Pg. 37	Pg. 37	Pg. 38	Pg. 38	Pg. 38

Fasteners: see pages 45-47

ROOFING, SIDING & FENCING

RoofPro445XP	SCN49XP	PS15RXP	BC58 Cap	A11 Stapling Hammer
8V0001N	5J0001N	9U0001N	4A0001N	PC0700
				
Pg. 49	Pg. 49	Pg. 50	Pg. 50	Pg. 50

Fasteners: see pages 51-53

PALLETS & CRATING

PalletPro57FXP	PalletPro100XP	PalletPro130XP	DFXP	F75LXP	F75SXP
4L0001N	5L0001N	5M0001N	8H0001N	8J0002N	8J0001N
					
Pg. 55	Pg. 55	Pg. 55	Pg. 56	Pg. 56	Pg. 56

Fasteners: see pages 57-59

UPHOLSTERY & FURNITURE

SFT10XP, SFT10XP Long Nose, SFT10XP Double Length Magazine	SFW09	NS20BXP
SEE SPECIFICATIONS	4C0001N	9Y0001N
		
Pg. 61	Pg. 62	Pg. 62

Fasteners: see pages 63-65

FLOORING

SHF200	SLS20XP-HF
8D0001N	490021N
	
Pg. 67	Pg. 67

Fasteners: see page 68



AIR COMPRESSORS & KIT

PC1131	PC0968	PC1280	PC1010	PC1010N	PC0947
					
Pg. 71	Pg. 71	Pg. 71	Pg. 71	Pg. 71	Pg. 71

SENCO innovation:

new staplers, engineered to last.

N-WIRE FAMILY:



Setting the new standard for class-leading power and tool durability, the NS family of tools is the industry benchmark for construction staplers.

■ NS20XP – Page 38

■ NS20BXP – Page 62



P-WIRE FAMILY:



Constructed of durable, high strength components, the PS family has been developed for extreme performance and longevity.

■ PS15XP – Page 37

■ PS15RXP – Page 50

■ PS20BXP – Page 37



SENCO®

Looking for more?



Contact Us

4270 Ivy Pointe Blvd.
Cincinnati, OH 45245

Phone: 800.543.4596
Fax: 800.543.3299



Visit Us

On the web for more information
SENCO.com



Find Us

Search for your closest SENCOR dealer
SENCO.com/dealer-locator



Join Us

Join our loyalty & rewards program
SENCOPROteam.com



Watch Us

Check out all of our latest videos & product launches
YouTube.com/SencoBrands



Follow Us

On Twitter & Facebook for the latest SENCOR news

  @SENCORBrands